

Personal Computer

US \$2.00/FF8.80/LIRE 1700/DM 3.80/FL 4.00/BF 55
DKr 10.75/Skr 7.85/Nkr 8.25/A Sch 28/S Fr 3.50/Pts 135

World

FEBRUARY 1980 50p

ACT 800
POWERFUL AND
PET COMPATIBLE

EUROPE'S LEADING MICRO MAGAZINE



CASE STUDY: MICRO-ASTROLOGY
Roger Elliot charts his way to success

The computer with growth potential

The System Three is Cromemco's best selling small business computer. It's easy to see why.

Not only is it ideal for the first time computer user. But perhaps more important, it can be expanded into a comprehensive business facility servicing many varied company requirements.

Single-user system

You can start small. A 64K computer with a megabyte of floppy disc storage costs under £4,000.*

Perhaps your initial reason for choosing Cromemco was its flexible database management system—ideal for client records, order processing, sales analysis, inventory control, and many more business uses; or you might have required the full screen word processing system, capable of printing up to 20 original letters an hour; possibly you needed Cobol, Basic or Fortran, to develop your own customised packages.

Easy to use

Whatever the reason, you were highly impressed with the ease with which your very first computer application got off the ground. So you added another. And another. And pretty soon quite a lot of company business was running on your Cromemco.

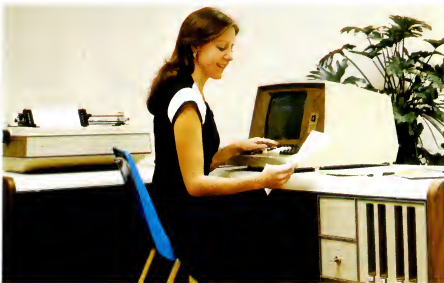

Single-user System Three, with 64K memory, 2 discs, terminal and printer. Ideal for small businesses.

Will it expand?

It was then you discovered that the terminal is the limiting factor, because of the time taken to input data. If only you could connect a second terminal you could double your system's workload. . .

Multi-user system

Fortunately, we can readily expand your Cromemco. Unlike other makers' systems, all we need to do is add some memory and a TU-ART interface, and the multi-user system is ready to run . . . with a printer and up to 7 terminals, each with up to 48K.

New operating system

Moreover, your terminals can function quite independently of each other. Under Cromemco's new operating system they can be used to update and interrogate the company's database; for correspondence, with the word processing system; for data entry, using the full screen editor; or indeed for running any combination of CP/M software, *simultaneously*.

Up to 72 megabytes

We can increase your floppy disc storage to 2 megabytes if necessary. And if that's not enough, we can also add Cromemco's hard discs to provide you with up to an amazing **72 megabytes** on-line.

Rely on MicroCentre

Remember—at MicroCentre we fully understand Cromemco systems. That's why we're Cromemco's top UK distributors. So trust your initial Cromemco investment to MicroCentre. And call us any time to discuss your hardware enhancements or software needs.

Your company's future growth may depend on it.



Multi-user System Three, with 320K memory, 4 discs, 7 terminals and fast line printer. Each terminal has its own operating system, and can run any software package independently.

*Price excludes VAT and delivery. Terminals and printers to be added according to user requirements. ® TU-ART is a Cromemco trademark.

For  **Cromemco... call the experts**

Tel. 031-225 2022

Micro Centre

Complete Micro Systems Ltd., 132 St. Stephen Street, Edinburgh EH3 5AA

CONTENTS

Volume 3 No. 2 February 1980

32 NEWSPRINT
Guy Kewney updates on the micro news.

38 BENCHTEST EXTRA ACT tosses its latest import into the ring — the 800.

42 COMMUNICATION
Reader's letters... word from the people that count.

47 B.C.S. REPORT
Fanfare for the British Computer Society.

48 BENCHTEST
This month, Mike Dennis examines the Heath WH-89.

54 BOOKFARE Malcolm Peltu studies the latest offering of "micro-guru", Adam Osborne.

56 SYSTEMS The subject this issue, Purchase Ledger.

58 COMPUTER ANSWERS Sheridan Williams & Co. add a few more timely explanations.

60 MICRO-ASTROLOGY Famous micro "star-charter", Roger Elliot, tells how he does it.

65 PCW SURVEY PRIZEWINNERS
Was it YOU who won the Sharp? The suspense reaches a climax.

66 CHECKOUT 1 For this issue, quick looks at Vector Graphic's Flashwriter.

69 COMPUTER GAMES David Levy continues his new series — "And then there were two".

72 CALCULATOR CORNER Dick Pountain introduces another page of "calc-talk".



Cover Illustration
Catherine Denvir

Published by SportsScene Publishers (PCW) Ltd., 14 Rathbone Place, London W1P 1DE, England. Tel: 01-637 7991/2/3. Telex: 8954139 A/B 'Bunch' G. London.

Copyright notice
Personal Computer World is published by SportsScene Publishers (PCW) Ltd. © 1980 Felden Productions. No material may be reproduced in whole or part without written consent from the copyright holders.

Printed by Riverside Press, Whitstable.

Distributed by Seymour Press Ltd., 334 Brixton Road, London SW9 7AG.

PCW welcomes all unsolicited material (written, photographic and illustrative) and although no guarantee can be given as to its safe return, reasonable care and attention will be exercised.

73 ON THE LINE
Part two of David Hebditch's now famous battle with the PO.

78 LINKING WITH THE OUTSIDE WORLD The "whys and wherefores" of the IEEE-488 bus.

80 THE COMPLETE PASCAL This month... records and files.

87 CHECKOUT 2
Tandy goes oriental... it's the Video Genie.

89 YOUNG COMPUTER WORLD John Coll highlights more submissions from our younger readers.

90 DIRECT ACCESS — IN STORE, USER GROUPS INDEX, UPDATE, DIARY DATA, FAX, TRANSACTION FILE.

101 PROGRAMS
Another mixed bag of listings.

109 LEISURE LINES
More "brainstorms" from J.J. Clessa.

Founder
Angelo Zgorelec

Editor
Bruce Sawford

Technical Editor
David Tebbutt

Consultants
John Coll, Mike Dennis, Charles Sweeten, Michael James, R.W. Davy, David Hebditch, Sheridan Williams, Dr. D.J. Hand, Dr. Adrian V Stokes.

Advertising Manager
Stephen England
(01-631 1736)

Micromart
Jacque Hancock
(01-631 1682)

Group Advertising Director
Richard Howell (01-631 3187)

Production Manager
Dick Pountain

Art Director
Paul Carpenter

Art Assistants
Jimmy Egerton, Julia Davies

Typesetter
Jane Hannell

Guidelines for contributors
PCW welcomes articles of interest. Don't be put off if your style of writing is 'under developed'. True worth lies in the content, and shaping features comes naturally to us! Manuscripts should not exceed 3,000 words and authors as asked to use triple-spaced lines with a wide left-hand margin; diagrams, listings and/or photographs should be included wherever possible. Please enclose a stamped, self-addressed envelope if you would like your article returned.

Because of the foregoing, it is necessary to add that the views expressed in articles we publish are not necessarily those of Personal Computer World. Overall, however, the magazine will try to represent a balanced viewpoint.

Finally, before submitting an article, please check it through thoroughly for legibility and accuracy.

Subscription rates: Britain £8.00 for 12 issues, USA \$20 for 12 issues (surface mail). Continent and elsewhere £9.80 for 12 issues. All prices include postage and packing. Supplies to specialist shops can be arranged by negotiation direct with the publishers.

LOW COST FLOPPY DISK SYSTEMS FOR YOUR TRS80 FROM CUMANA

The high quality and very reliable
TEAC FD-50A 5¼ inch mini floppy drive packaged
in single disk and dual disk configurations with
integral mains power supply unit.



SINGLE DISK UNIT £250

DUAL DISK UNIT £440

- * Shugart SA 400 compatibility
- * Extra 5 tracks – 40 total
- * 125K bytes unformatted on 40 tracks
- * Daisy chain up to 3 FD-50A drives
- * Plugs directly onto your TRS 80 disk interface cable
- * Japanese quality and reliability
- * 220v-240v 50HZ Mains power input
- * Full warranty and service back up from Cumana

DEALER ENQUIRIES WELCOMED

Please add VAT to all prices. Delivery at cost will be invoiced separately.
Make cheques payable to

CUMANA LTD

35 Walnut Tree Close, Guildford, Surrey GU1 4UN
Tel: (0483) 503121 Telex: 859680 (INPUT G)

The Perfect Lead... Acorn Microcomputer System 1



Price £65 plus VAT in kit form

This compact stand-alone microcomputer is based on standard Eurocard modules, and employs the highly popular 6502 MPU (as used in APPLE, PET, KIM, etc). Throughout, the design philosophy has been to provide full expandability, versatility and economy.

Specification

The Acorn consists of two single Eurocards.

1. MPU card
6502 microprocessor
512 x 8 ACORN monitor
1 K x 8 RAM
16-way I/O with 128 bytes of RAM
1 MHz crystal
5 V regulator, sockets for 2K EPROM and second RAM I/O chip.
2. Keyboard card
25 click-keys (16 hex, 9 control)
8 digit, 7 segment display
CUTS standard crystal controlled tape interface circuitry.
Keyboard instructions:
Memory Inspect/Change (remembers last address used)
Stepping up through memory
Stepping down through memory

Set or clear break point
Restore from break
Load from tape
Store on tape
Go (recalls last address used)
Reset
Monitor features
System program
Set of sub-routines for use in programming
Powerful de-bugging facility displays all internal registers
Tape load and store routines

Applications

As a self teaching tool for beginners to computing.
As a low cost 6502 development system for industry.
As a basis for a powerful microcomputer in its expanded form.
As a control system for electronics engineers.
As a data acquisition system for laboratories.

START WITH SYSTEM 1 AND CONTINUE AS AND WHEN YOU LIKE



Acorn Controller
£35 plus VAT (min config.)

the CPU card of System 1, it allows for up to 4½ k EPROM, 1½ k RAM and 32 I/O lines. It has on board 5 V regulator and optional crystal control. Custom programs may be developed on System 1 and the card makes an ideal dedicated hardware module.



Acorn Memory 8 k
£95 plus VAT (kit form)

A fully buffered memory card allowing up to 8 k RAM plus 8 k EPROM on one eurocard, in an Acorn system both BASIC and DOS may be contained in this module. Static RAM (2114) is used and the card may be wired into other systems.



Acorn VDU
£88 plus VAT (kit form)

A memory mapped seven colour VDU interface with adjustable screen format. Full upper and lower ascii and teletext graphics are features of this module which along with programmable cursor, light pen, hardware scroll etc., make this the most advanced interface in its class.

Acorn Software
in ROM

- Acorn BASIC — a very fast integer BASIC in 4 k
- Acorn COS — a sophisticated cassette operating system with load and save and keyboard and VDU routines in 2 k
- Acorn DOS — a comprehensive disc operating system in 4 k

Acorn Computers Ltd.
4A Market Hill, Cambridge, Cambs.
Cambridge (0223) 312772.

Order Form

Please send me the following:

- (qty) Acorn Microcomputer kit @ £65 plus £9.75 VAT.
- (qty) Acorn Memory kit @ £95 plus £14.25 VAT.
- (qty) Acorn VDU kit @ £88 plus £13.20 VAT.
- (qty) Acorn Power Supply (for System 1 only) @ £5.95 plus £0.89 VAT.
- (qty) Acorn Microcomputer assembled and tested @ £79 plus £11.85 VAT.
- (qty) Acorn VDU assembled and tested @ £98 plus £14.70 VAT.

Post and packing free on all orders.

PCW FEB

I enclose a cheque for £
(indicate total amount) made out to Acorn Computers Ltd.
Please send me further details of this and other Acorn options

Name _____
Address _____

**ACORN
COMPUTER**

Acorn Computers Ltd. 4A Market Hill, Cambridge, Cambs. (0223) 312772. Regd. No. 1403810

*New! Produced in the UK and widely used here and in the USA —
COMPLETE BUSINESS PACKAGE*

***PROGRAMS ARE INTEGRATED**

- 1 = ENTER NEW NAMES ADDRESSES IN LINE!
- 2 = *ENTER/PRINT INVOICES
- 3 = *ENTER PURCHASES
- 4 = *ENTER A/C RECEIVABLES
- 5 = *ENTER A/C PAYABLES
- 6 = ENTER/UPDATE STOCKS REC'D
- 7 = ENTER ORDERS REC'D
- 8 = EXAMINE/UPDATE BANK BALANCE
- 9 = EXAMINE SALES LEDGER
- 10 = EXAMINE PURCHASE LEDGER
- 11 = EXAMINE INCOMPLETE RECORDS
- 12 = EXAMINE PRODUCE SALES

SELECT FUNCTION BY NUMBER

- 13 = PRINT CUSTOMER STATEMENTS
- 14 = PRINT SUPPLIER STATEMENTS
- 15 = PRINT AGENTS STATEMENTS
- 16 = PRINT QUARTERLY TAX STATEMENTS
- 17 = PRINT WEEK/MONTH SALES
- 18 = PRINT WEEK/MONTH PURCHASE
- 19 = PRINT YEAR AUDIT
- 20 = PRINT PROFIT/LOSS ACCOUNT
- 21 = UPDATE ENDMONTH FILES
- 22 = PRINT CASHFLOW ANALYSIS
- 23 = ENTER PAYROLL

WHICH ONE (ENTER 1 to 24)

Sub-menu example : 01=examine:02=insert:03=amend:04=delete 05=print(1,2,3)
06=numeric combinations:07=sort

VERY FLEXIBLE. ADD YOUR OWN FUNCTIONS.EASY TO INTEGRATE

ALL PROGRAMS IN BASIC FOR CP/M. PET. 6800

PRICES:

PROGRAMS	1-23 excl 19,20,22&23	£475.00
	1-23 inclusive	£575.00
	Stock integrated option — add	£100.00

We export to all countries: Callers by appointment only:

Contact Tony Winter. Tel: 01-636 8210

G. W. COMPUTERS LTD

89 Bedford Court Mansions, Bedford Avenue, London WC1

IMPORTANT! We also sell the hardware to do the above tasks so you can purchase the entire package from one source.

PET Computer 32K	£795.00
PET Floppy Disk	£795.00
PET Printer (Tractor-feed)	£645.00
PET cables	£ 45.00
Paper	£ 28.50
10 Diskettes	£ 28.50
1 years software support	£ 50.00
	£2387.00

SUPERBRAIN Z80 Twin 5¼" D/Density floppies	
32K RAM;	£1950
64K RAM	£2095

PRINTER OPTIONS

Paper Tiger (195cps)	£ 595.00
Texas 810 (150cps)	£1495.00
Teletype 43 (30cps)	£ 895.00
DEC LA34 (30cps)	£ 895.00
Qume Daisywheel (45cps)	£2450.00
NEC Spinwriter (55cps)	£1950.00

SPECIALS

48K Industrial Microsystems Z80 + twin 5¼"	£2000.00
D/Drives	
Intertube video terminals	£ 495.00
40K SWTPC 6800 + twin 5¼" S/Density drives	£1000.00

Call for special all in deal offers

Warranty includes free replacement of equipment within 90 days if found defective.

WALKIE-TALKIE TELEPHONE (Freedom Phone)

connects to normal telephone, make or take calls up to 300ft. from home. (not P.O. approved)

£195.00

TELEPHONE ANSWERING MACHINES

Recall messages from anywhere in world (not P.O. approved)

£195.00

We export to all countries: Callers by appointment only:

Contact Tony Winter. Tel: 01-636 8210

G. W. COMPUTERS LTD

89 Bedford Court Mansions, Bedford Avenue, London WC1

Thinking Computers?



Then come to the number one micro-computer centre

If you're wondering if a micro-computer can help you, we are here to advise you. At Lion House—London's leading centre for micro-computers—you'll find:

- * Experts who'll explain the equipment in a way you can easily understand, showing how and where it applies to *your* work.

- * Demonstration areas where you can get immediate experience of using micro-computers yourself.

- * Probably the biggest range of software in the UK.

- * Programmes can be tailored for your particular commercial needs by our In-House Analysts and Programmers.

- * Total service—including the availability of full maintenance after you've bought an installation.

- * Leasing and H.P. facilities immediately available.

- * A computer book section with publications that give you new insight into the world of micro-computers.

How will micro-computers help you? In thousands of ways—only a few can be mentioned here...

MICRO-COMPUTERS FOR BUSINESS



For business and professional, the versatility of compact micro-computers means that all the benefits of big computers are made available to all at low cost. The businessman can now computerise his accountancy, his stock control, his records and much more—cutting his overheads and improving his efficiency.

For the home, micro-computers have innumerable uses and considerable value too—sometimes in unexpected ways.

MICRO-COMPUTERS FOR THE HOME



Budgeting... investments... controlling heating or security... storing information on things like recipes... designing complex and fascinating games... education...

Come and see. We invite you to visit us and investigate the possibilities and the potential. If you're too far away, phone or write and we'll send you more information.

You need a micro-computer. We can supply it.



LION MICRO-COMPUTERS

SMALL COMPUTERS—TO MAKE YOUR BUSINESS BIGGER

Lion Computer Shops Ltd, Lion House, 227 Tottenham Court Road, London W1 (First Floor). Telephone: 01-6371601.

Telex: 28394 Lion G.

Open 9 to 6, Monday to Saturday (Thursday to 7).



You're invited to come
and see the

PetSM BUSINESS SYSTEMS

at your official
COMMODORE 
and **Petsoft**
dealers in . . .

Stockton-On-Tees



Combine the NEW large keyboard PET with the ACT PETSOFT Professional Disk Systems and Software, and the result is a powerful business tool. If your application includes Sales Ledger, Invoicing, Purchase Ledger, Payroll or Stock Control, then come and see us without delay.

Intex (Datalog) Limited

Eaglescliffe Industrial Estate, Eaglescliffe
Stockton-on-Tees, Cleveland TS16 0PN England
Telephone Eaglescliffe 781193 (STD Code 0642)
Cables Intexrad, Stockton-on-Tees, Telex 58252

. Trade enquiries welcomed.



...when you need a dependable supplier, an authorised distributor with a comprehensive range of products at keen prices, backed by large stocks for fast delivery, with full after-sales support. We promise you a rapid response.



ANADEx DP8000

Exceptional value and high reliability. 84 lines per minute. 112 cps. Parallel and serial interfaces as standard. 96 ASCII set, 9 x 7 font. Variable tractor. Forms handling facilities. 1K buffer store. Options include 2K extra store IEEE interface.

from only **£540**



LEAR SIEGLER ADM-3A

The most popular visual display in the world. 1920 character screen capacity. Cursor addressing. Dual interface. Auxiliary port. Wide range of speed and word formats. Options include Tektronix 4010 compatible graphics.

from only **£570**



LEAR SIEGLER ADM-31

Low cost VDU with two page display and full editing features. Dual interface. 50-9500 baud data rates. Upper/lower case character set. Cursor addressing, editing, protected fields, dual intensity. Optional polling and addressing, printer port.

from only **£795**



TELETYPE 43

Versatile, economic and reliable. 30 cps serial interface keyboard printer. 132 or 80 columns. 94 ASCII set, 9 x 7 font. Crisp, high quality printout. Microprocessor controlled. Portable versions. Character set options.

from only **£799**



TYPEWRITER TERMINAL

Two machines for the price of one. Typewriter style friction feed for single documents, letters etc. Pin feed for continuous business stationery. Electric typewriter keyboard layout and touch. Left and right hand margin setting. Crisp, high quality printout.

from only **£825**



TEXAS 810

Compact 150 cps 132 column printer. Optimised bi-directional printing. Adjustable tractor feeds. 3 1/2 inches. 9 x 7 dot matrix. RS232 interface. Forms control options. Other serial and parallel interface options. Compressed print option.

from only **£1392**

LOW COST GRAPHICS TERMINAL



£1295

A low cost Tektronix 4010 compatible option means that we can offer the well-known Lear Siegler ADM 3A with powerful graphics capability. A Z-80A microprocessor and RAM sufficient to provide a 512 x 250 dot grid and automatic scaling from a 1024 x 780 dot grid enable point plotting, vector drawing and alphanumeric character display.

PERIPHERAL HARDWARE LIMITED

Armfield Close West Molesley Surrey Telex 922175

SOUTH
01-941 4806

NORTH
Harrogate 501263/4

IRELAND
Dublin 952316

INNOVATIVE

TRS-80 SOFTWARE

FROM THE PROFESSIONALS

EDITOR/ASSEMBLER PLUS

Now get every feature of Tandy's Editor Assembler and T-Bug all in one package. PLUS - many "big computer" features to simplify your programming, editing and debugging. Its no longer necessary to waste time creating both source and object tapes - Assembler Plus assembles directly into memory. Macros are supported, simply define a Macro and any frequently used sequences are automatically assembled. Assembler Plus also supports Conditional Assembly with 2 new pseudo ops, which enable assembly if a condition is true. There are 7 new expressions available, together with an automatic ORG, improved symbol print out and a Quash command to give you more storage space for general text editing. And that is all just on the Assembly side! The Editor is improved with extra commands like Substitute, Move, Copy and Extend for moving entire blocks and repeating them anywhere in the file, and for searching and substituting occurrences in old text for new text. A Range command is available for both Edit and Find enabling you to operate on a single line or a range of lines. Included in the package is a debugger called Z-Bug which includes all of the features of Tandy's T-Bug and features single step execution, direct execution in command mode and symbolic references, plus up to 8 breakpoints, rather than the single one in T-Bug. Editor/Assembler Plus is written by the original author and comes with an 80 page Manual - best of all it costs the same as Tandy's Editor/Assembler alone!

Editor/Assembler Plus for 16K Level II. Cassette based.....£21.70 + VAT = £24.95 50p P & P

ADVENTURE

The original Adventure was written for a main frame computer and was called Adventureland. Since then there have been many derivatives. The best are written in machine code like the Scott Adams series (for which label we happen to be the sole importers!) but good as they are, they have had to be shortened to fit into 16K. This Microsoft Adventure is the original uncut main frame version, for the first time available for a microcomputer. Once you enter the Colossal Cave, your journey takes you through a labyrinth of caves containing active volcanoes, green snakes, sulfur lakes, killer dwarves, trolls, five foot oysters and many many more surprises before you can collect the 25 Treasures and be a Grand Master! All the while directing your journey with commands and questions to the computer in English. Over 400 messages and descriptions are combined in an endless number of ways in the program vocabulary. Almost literally mind blowing!

Adventure. 32K single drive minimum. Disk based£19.50 + VAT = £22.43 50p P & P

ASSEMBLY LANGUAGE PACKAGE

A Complete Assembly Language package for the user who requires the ultimate in programming aids. This package consists of a Macro Assembler, a Linking Loader, a Text Editor and a Cross Reference Facility. The Macro Assembler accepts Z-80 opcodes and supports a complete Intel standard macro facility including IRP, IRPC, Repeat, local variables and ExitM. The code is assembled in relocatable modules which offer the advantages of easier coding, faster testing, debugging and modifying. An expanded set of conditional pseudo ops allows testing of assembly pass, symbol definition and parameters to macros. Other assembler features include comment blocks, octal or hex listings, titles and subtitles, variable input radix (base 2 to 16) and a complete set of listing controls. The Linking Loader provides a number of loader capabilities executed by means of easy command lines and switches. Any number of programs may be loaded in user specified locations. Internal and external references between modules are resolved automatically. The Loader also performs library searches for system subroutines and generates a load map of memory showing the locations. The Text Editor is a random access line orientated text editor similar to those used on the IBM 360 and PDP-10 computers. The Editor's speed and simplicity make it easy to insert, replace, print or delete lines; edit individual lines; renumber lines in a file and to find or substitute specified text. The Cross Reference Facility provides a convenient alphabetical list of all program variable names, together with the line numbers where they are referenced and defined.

Assembly Language Package. 32K single drive minimum.....£65.00 + VAT = £74.75 50p P & P

FORTRAN

The best Fortran Language Compiler available for the TRS-80 - a standard ANSI Fortran from Microsoft. The package includes the Compiler, a Linking Loader, a Text Editor and a Fortran Runtime Library. The Compiler has a number of enhancements to the ANSI standard: LOGICAL variables which can be used as Integer quantities, +127 to -128; LOGICAL DO loops for tighter, faster execution of small valued Integer loops; mixed mode arithmetic; hexadecimal constants; Literals and Holleriths allowed in expressions; logical operations on integer data AND..OR..NOT..XOR can be used for 8 or 16 bit Boolean operations; READ/WRITE End of File or Error Condition transfer, that is, control may be transferred to a specified statement on end of file or error encounter; Encode/Decode for Format operations to memory. The standard library supplied includes 49 subroutines, together with routines for 32 bit and 64 bit floating point functions. Users may write non-standard I/O drivers for each Logical Unit Number - making the task of interfacing non standard devices to Fortran, a straightforward one.

Fortran Package. 32K single drive minimum.....£65.00 + VAT = £74.75 50p P & P

Send large SAE (27p) for our current Catalogue of TRS-80 Software. Add £1.45 for a binder.

A.J.HARDING (MOLIMEX)

28 COLLINGTON AVENUE, BEXHILL-ON-SEA, E.SUSSEX. TEL: (0424) 220391

TELEX 86736 SOTEX G FOR A. J. HARDING



VERBATIM MAGNETIC MEDIA



THE BEST THAT MONEY CAN BUY.

VERBATIM — the world's finest and best known range of magnetic data storage products — includes Floppy Discs, Mini-Floppies, Cassettes, Mini-Cassettes, cartridges and cards. All are 100% tested during manufacture, all are *certified* error free. We stock all types, including all varieties of the popular 5 1/4-inch floppy discs.

If you are a dealer:

Start stocking VERBATIM products — your customers will appreciate a better quality product at better prices. Call BFI Electronics for a comprehensive catalogue, dealer price list, and details of display material and retail packaging.

If you are a user:

Your system is only as good as its data storage — so don't be content with inferior products. Insist on VERBATIM by name, as indeed do some of the biggest names in the computer business!

BFI

BFI Electronics Limited
516 Walton Road,
West Molesey,
Surrey KT8 0QF
Tel: 01-941 4066
Telex: 261395

aculab Ltd

>ACULAB 735, a fully self-contained interface for IBM 735 output golfball typewriters.

The ACULAB 735P INTERFACE is a self-contained controller for IBM I/O typewriters and printers. The 735P accepts standard 7-bit parallel ASCII data and provides all of the handshake protocol, code conversion and solenoid voltages to run the printer at full speed using any correspondence or ASCII golfball to produce letter quality printing at 15 chars/sec ... £155.00 + VAT

The TRS-1 PARALLEL PORT DECODER plugs into the bus connector on the TRS-80 keyboard and decodes the port used by the ELECTRIC PENCIL and the LPRINT and LLIST commands in TRS-80 BASIC. ... £55.00 + VAT

The IEEE TO PARALLEL PORT CONVERTER plugs onto the PET IEEE bus connector and converts it into a parallel printer port. It also converts PET's unique version of ASCII to standard ASCII and provides a switch to give UC/LC compatibility with the new PET ... £45.00 + VAT

The ADDRESSABLE IEEE PARALLEL PORT DECODER has all of the features of the converter but may be set to answer to any of the available addresses on the PET IEEE bus and so be used along with the PET disc or any other bus compatible devices ... £66.00 + VAT

These last three devices are all fitted with 2 metres of heavyweight cable and a metal shrouded Centronics compatible connector.

IBM 735 typewriters and 1051 printers are available wired tested and ready to go. Trade enquiries welcome.

aculab Ltd.

24 Heath Road,
Leighton Buzzard, Beds.
LU7 8AB

For further information
Telephone. 0525-371393.

Professional ASCII Keyboards



MODEL KB 756

FULLY ASSEMBLED & TESTED
CASE AVAILABLE

Accessories Available include:—

Edge Connector	KB15P	£1.95*
Numeric Key Pad	KB710	£7.50*
Plastic Case (Black)	KB701	£10.75*
DC to DC Converter	DC512	£5.00*

* U.K. Orders add 15% VAT on Order total.

FULL DATA SHEET ON REQUEST

Citadel Products Limited.

Dept. PCW 50 High Street, Edgware,
Middlesex HA8 7EP. Telephone 01-951 1848

**CARTER
KEYBOARDS**



MERSEY
MICRO
SHOW

WAVE THE FLAG

At the Adelphi Hotel, Liverpool,
30th April 1, 2, May 1980

This will be the first ever major microcomputer event to be held in the North West of England. The show has the approval of the Department of Industry and is supported by the North West Industrial Development Association.

The Exhibition

Major microcomputer manufacturers and local companies will be exhibiting their latest products and special services. Organisations who have not yet confirmed their space booking should contact Jane McBarnet immediately. AND REMEMBER, exhibitors at the 1980 Microcomputer Show, London and the Mersey Micro Show will be eligible to 10% discount on both events.

The Seminars

The first two days will be an introduction in non-technical terms to the vast potential of micros both as a manufacturing tool and as a personal aid in business. The third day will show how word processing and other electronic devices are already revolutionising offices throughout the country.

Return this coupon or call
Online Conferences Ltd,
Cleveland Road, Uxbridge,
Middlesex UB8 2DD.
Telephone 0895 39262

online

Please send 1980 Microcomputer Show Exhibition details.
 Please send Mersey Micro Show Exhibition details.

Name _____

Address _____

Tel No. _____

PCW

Graham Knott & Jeff Orr now moved....

to new premises due to expansion
to accommodate larger stock and
workshop facilities for the
Microcomputer user.
Our new number is

051-933 5511

ring us at any time for your
requirements



NEW Vastly improved 625 TV adaptor for Pet. Handles reverse field graphics, exceptional picture. **£25 complete plus VAT**

PET	
Pet 8k	£550
Pet 16k	£575
Pet 32k	£795
2nd Cassette	£55

Disk Units	
400k Random and Sequential complete, to fit 8k Pet (via expandamem)	£795
to fit 16/32k Pet (direct fitting)	£840
Memory Expansion	
24k Expandamem for Pet	£320
Interfaces	
Uni-dirc I-EEE to RS232	£89
Bi-dirc I-EEE to RS232	£140
Bi-dirc 2 ported I-EEE to RS232	£175

A/D Converters	
AIM 161 16 channel A/D converter for Apple, Aim, Nascom etc	£130
Petset 1, AIM 161 including all interfacing requirements for Pet, complete	£166

Stack Peripherals	
Stack Joystick a balanced, calibrated unit supplied with software and examples of use, complete	£25
New 625 Video Adaptor a vast	

improved 625 video converter for Pet, works extremely well
Stack Page Printer Interface screen contents out 20m.a. loop complete with software **£25**

APPLE	
Apple II (colour) 16k	£985
Apple-plus (b&w) 16k	£830
ITT 2020 (colour) 16k	£950
16k RAM upgrade	£85
Printer Card	£110
Communication Card	£140
High Speed Serial Card	£110
Disk Drive with DOS	£425
Extra Disk Drive	£375
Diskettes (10's)	£30

SORCEROR	
Sorcerer 16k	£760
Sorcerer 32k	£859
AIM 65	£249.45
NASCOM	£165
KIM I	£99.95
MANUALS New Pet user manual	
6500 Programming manual	£5
6500 Hardware manual	£5

PRINTERS	
Teletype 43 pinfeed RS232	£860
friction RS232	£885
pin and friction RS232	£920
Anadex DP8000	£575

Perkins Elmer Pussycat CRT copier	£839
Also Centronics Range, Instruments, Lear Siegler	
Ring us for a quote on individual models.	

Consumables

(All paper add £5 carriage per box)	
Anadex DP8000 paper (2000 sheets) 9.5" x 11" drop	£15
Teletype 43 pinfeed paper (2000 sheets) 12" x 11" drop	£15
8.5 inch friction roll Box 'A' quality (12 x 3.5" diam rolls)	£20
Box 'B' quality (12 x 3.5" diam rolls)	£15
Box 'A' quality (6 x 5" diam rolls)	£20
Box 'B' quality (6 x 5" diam rolls)	£15

Cassettes	
C15 cassettes, high quality tape, 5 screw cassette cases, per 10	£4.40

Disks & Diskettes
We supply 8" and 5.25" diskettes for all disk drives. Please state your machine and we can give you a quotation.
e.g. Pet 2040 **£30 per 10**
Computhink **£30 per 10**
Apple **£30 per 10**
Horizon **£30 per 10**
Sorcerer **£30 per 10**
Many others in stock, both hard and soft sector.

Connectors	
Pet User Port/I-EEE Port	£1.10 each
Pet 2nd cassette Port	85p each
Hoods for User/I-EEE connectors	£2.25
D.25 RS232 Connectors (State Male or Female)	£3.00
D.25 Hoods	£2.25

Demagnetiser	
Curved head	£4.00
If any requirements are not listed please ring us as we may have them in stock.	

All prices are - VAT at 15% end include carriage (unless otherwise stated). Please make cheques payable to Stack Computer Services Ltd.

Stack Computer Services Ltd

290-298 Derby Rd, Bootle

Liverpool 20

MEET THE FAMILY



... THERE MUST BE ONE HERE FOR YOU

The Exidy family is a sophisticated range of products designed to meet the ever increasing variety of computing needs, including home and business uses, educational and laboratory applications, industrial process control etc. The Exidy range has been designed with built-in growth capacity to take the risk factor out of computer investment. The Sorcerer Computer now has a memory expansion capability from 8K up to 48K within its own cabinet, enabling the system to grow with your needs plus the ability to add many additional plug-in facilities such as disk drives and pre-programmed ROM PAC's.

The standard configuration includes a 63 key typewriter-style keyboard and a 16 key numeric pad. Remote control for dual cassettes. Serial RS232 and parallel interfaces, Z80 processor, 4K resident operating system, 8K Microsoft BASIC in separate plug-in ROM PAC cartridge, 64 character x 30 line display, 128 upper/lower case ASCII character set and 128 user defined graphic symbols, operators manual, introduction to basic programming, connecting leads. All Exidy equipment is backed up by a 12 month warranty covering both parts and labour.

The Word Processing ROM PAC features auto wraparound, dynamic cursor control, variable line length, global search and replace, holding buffer for re-arrangement of text, right justification, line width and line to line spacing, underlining or boldfacing, text merging and a macro-facility permitting tasks such as formletter typing, multiple column printing of automatic forms entry.

Now contact your nearest dealer:

The NORTH

ANDOR ELECTRONICS LTD., 11 The Precinct, Romily, Stockport. 061430 4770
BASIC COMPUTING, Oakville, Oakworth Road, Keighley, W. Yorkshire. 0535 65094
E. S. MICROCOMPUTERS, 7 Berkeley Precinct, Eccleshall Road, Sheffield S11 8PN. 0742 668767
GLYSTHYDON LTD., Nook Farm, Reke Lane, Warton, Preston, Lancs. 0772 633138
MICRODIGITAL, 25 Brunswick Street, Liverpool L2 0BJ. 051 227 2535
MICROPUTE, 7 Westbourne Grove, Manchester M20 6JA. 0625 612 818

MIDLANDS

H. B. COMPUTERS, 22 Newland Street, Kettering, Northants. 0536 83922
M&R SYSTEMS, Westgate House, 23 Leverington Road, Wisbech, Cambs. 094571 2741
MIDLAND MICROCOMPUTERS, 1 Cherry Wood Drive, Aspley, Nottingham. 0602 298 281

LONDON and the SOUTH EAST

C. C. S. MICROSALLES, 22 Westside, 60 Fortis Green, London N2 9EN. 01 444 7739
MICROBITS, 34b London Road, Blackwater, Camberley, Surrey. 0276 34044
SLOUGH MICROSHOP, 120 High Street, Slough, Berks. 0753 72470
HOME & BUSINESS COMPUTERS, 445 High Street, Manor Park, London E12. 01 471 1323
E. M. G., 30 Heathfield Road, Croydon, Surrey CR0 1E4. 01 688 0088
G. P. W. ELECTRONICS, 146a London Road, North End, Portsmouth, Hants. PO2 9DJ. 0705 693341
INFORMEX LTD., 61 Harland Avenue, Sidcup, Kent DA15 7NY. 01 300 0380
NEWBEAR COMPUTERS STORE, 40 Bartholomew Street, Newbury, Berks. RG14 5LL. 0635 30506
N. I. C., 27 Sidney Road, London N22 4LT. 01 889 9736
TVJ MICROCOMPUTERS, 165 London Road, Camberley, Surrey CU15 3JS. 0276 62506
WOODSTOCK COMPUTER SERVICES, 44 Hoggarden Road, Tunbridge, Kent. 0732 355349

WALES and the WEST

CAR RADIO LTD., St. Lawrence Yard, North Hill, Plymouth, Devon. 0752 69097
ELECTROPRINT, 5 Kingsdown Parade, Bristol BS6 5WD. 0272 292375
TRYFAN A. V. SERVICES, 3 Swifts Buildings, High Street, Bangor, Gwynedd LL57 1UW. 0248 52042

Or send coupon for further information to:

SOLE DISTRIBUTORS

Geoff Wilkinson
LIVEPORT DATA PRODUCTS
The Ivory Works, St. Ives, Cornwall.
0736-798157

PLEASE SEND DETAILS OF THE EXIDY RANGE

NAME _____

ADDRESS _____

Now Converted to 50HZ for UK TV's!

SUPERBOARD II

£188 + VAT

Full 8K basic and 4K user RAM
Built and tested



Software

Tapes at £5.50 + VAT

Homonyms*, Counter*, Trig Tutor, Bar Graph, Define, Interiors, Basic Math, Presidents*, Powers, Electronics Equations, Spelling Quiz, Solar System, Continents, Add Game, Math Intro, Base Ten Converter, Math Blitz*, Inventory Demo, Ratio Analysis, Advertisement, Statistics I, Salary Demo*, Annuity I, Annuity II, Interest on Loans, Loan Finance, Uneven Cash Flows, Personal Destroyer, Hide & Seek, Star Wars, Black Jack, New York Taxi, 23 Matches, Lander*, Etch-a-Sketch, Space War*, Battleship*, Cryptograph.

Tapes at £7.30 + VAT:-

Hangman, Mathink, Trend Line, Straight & Constant Depreciation, Address Book*, Checking Account, Savings Account, Bio-rhythm, Hectic.

Tapes at £11.00 + VAT:-

Word Processor**, Programmable Calculator, Tiger Tank

Basic Tutor Tape:- £26.40+VAT

Assembler editor with Manual

£25 + VAT

Extended monitor with Manual

£10 + VAT

Features

- Uses the ultra powerful 6502 microprocessor
 - BK Microsoft BASIC-in-ROM
 - Full feature BASIC runs faster than currently available personal computers and all 8080-based business computers
 - 4K static RAM on board expendable to 8K
 - Full 53-key keyboard with upper-lower case and user programmability
 - Kansas City standard audio cassette interface for high reliability
 - Full machine code monitor and I/O utilities in ROM
 - Direct access video display has 1K of dedicated memory (besides 4K user memory), features uppercase, lower case, graphics and gaming characters for an effective screen resolution of up to 256 by 256 points. Normal TV's with overscan display about 24 rows of 24 characters, without overscan up to 30 x 30 characters
- Extras
- Power Supply & modulator £29.50 + VAT
 - 610 Expansion board with 8K ram and dual drive miniflopp chip £188 + VAT
 - IP CD3P minifloppy disk, cased and with power supply £310 + VAT
 - Injection moulded case with in 6 weeks £35 + VAT
 - 4K Ram upgrade kits

We are dealers for the rest of Ohio scientific range of computers. The widest range produced by any micro computer manufacturer, this includes:-

- C2-4P A professional 4K basic in-ROM computer cased and with power supply
- C2-8P DF A 32K basic in ROM computer with dual 8" floppydisk drives for serious personal and small business use
- C3-DEM A 32K computer with 3 micro-processors (6502, 6800, Z80) and dual 8" floppydisk drives

Full business, word processing and cate base management is available for all disk based systems.
Write for catalogue for further details

LOTUS SOUND

4 MORGAN STREET
LONDON E3 5AB

TELEPHONE: 01-981 3993
TELEX: 261426 ATN. LOTUS SOUND

NEW!

MASTER PACK[®]

for Casio 501/502
with FA-1

PRE-RECORDED CASSETTE AND USER MANUAL FEATURING:

- * Over 150 ready-to-run programs on cassette - with voice introduction for fast access
- * Full CASIO PROGRAM LIBRARY ready for immediate use - PLUS
- * Extra GAMES - Lunar Lander, Codebreaker, Number Patience, Bomber Pilot, Fruit Machine, Wipeout, Roadrunner, math and strategy games, . . .
- * PERSONAL COMPUTER PROGRAMS - Bank account and credit card management, price comparator, advance bio-rhythm, diet and weight calculators, flexible Games Scoreboard.
- * POWERFUL SUBROUTINES for use in your own programs - display formatting, user prompts, data scrolling, data file management, . . .
- * DATA-PACKING - gives 502 100 - 200 easily-used single digit memories; OR 50 - 100 double digit memories - ESSENTIAL FOR STATISTICAL WORK

PLUS USER MANUAL:

- * Basic and Advanced Programming - fact-packed articles to develop your programming skills; everything you need to know but can't find in the CASIO manual!
- * Full Command Key-code Index for fast program de-bugging.
- * Comprehensive documentation for all MASTER PACK programs
- * 'From Our Programmer's Notebook' - programming tips and tricks special program sequences.

SEE REVIEW IN
"CALCULATOR CORNER"

MASTER PACK

for Casio 501/502 with FA-1

ONLY £17.95

Available from selected CASIO retailers, or send £17.95 direct to PREMIER PUBLICATIONS, 12 Kingscote Road, Addiscombe, Croydon, Surrey (cheques/POs only)

DEALER INQUIRIES INVITED - 01-656 6156

video genie system



The Video Genie System, EG 3003.
At last, value for money in microcomputers.

£425 incl VAT

- * 16k User RAM plus 12k Microsoft BASIC in ROM
- * Fully TRS 80 level II software compatible
- * Huge range of software already available
- * Self contained, cassette, PSU & UHF modulator
- * Simply plugs into video monitor or UHF TV
- * Full expansion capability for disks & printer

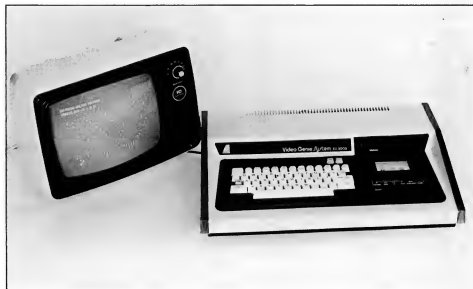

LOWE ELECTRONICS

LOWE ELECTRONICS LIMITED
BENTLEY BRIDGE
CHESTERFIELD ROAD
MATLOCK
DERBYSHIRE
DE4 5LEF

For full details please contact:
Telephone 0629 2817 or 2430
Telex 377482 LOWLEC G

TRADE ENQUIRIES WELCOME

TVJ

PET 2001



from
£475

commodore
authorised dealers

TRS 80



from
£365

From Radio Shack Corp.

APPLE II

from
£750



apple & ITT 2020
authorised dealers

SORCEROR

from **£740**



E
authorised dealers

COMPUCOLOR

from
only
£999



for computer with colour monitor, keyboard and integral disk drive. Second disk drive £316.00

MICROCOM

For Hardware, Software, Peripherals,

PET 3016 (16K RAM and large keyboard)*
PET 3032 (32K RAM and large keyboard)*

IEEE/RS232 Serial Interface 'A' Output only
IEEE/RS232 Serial Interface 'B' Input/Output

TRS 80, 4K Level I consisting of Keyboard with 4K memory, Video Unit, Cassette Drive and 240v power supply unit
TRS 80, 4K Level II (as above with Level II Basic)

TVJ 232C serial Interface
Centronics Parallel Printer Interface (direct to keyboard)
TRS 80, Voice Synthesizer
TRS Voxbox - speech recognition system
TRS 80, Numeric Key Pad supplied and fitted

Apple II Plus computer - APPLESOFT

Apple black and white modulator for domestic TV
Eurocolor card - provides colour on domestic TV
Parallel Printer Interface Card
High Speed Serial (RS232C) Interface Card
Communications Card
Centronics Card
Integer Basic Firmware Card
PASCAL language system - includes language card to provide user with PASCAL, APPLESOFT & INTEGER BASIC

Sorcerer 16K RAM (inc. UHF Modulator)

Exidy Video Monitor (High Resolution)
Exidy Video Disk Unit

BASIC SYSTEMS

PET 2001-8 (PET with 8K memory + integral cassette) £515.00
New 8K PET with large keyboard £475.00
PET C2N External Cassette Deck £53.00

ACCESSORIES

IEEE-448/Centronics type parallel Interface £45.00
IEEE to Pet Cable £19.00
IEEE to IEEE cable £24.00
Interface to S100 (4 slot motherboard) £112.00

BASIC SYSTEMS

TRS 80, 16K Level II (as above with 16K memory) £499.00
TRS 80, Expansion Interface with 16K RAM £275.00
TRS 80, Expansion Interface with 32K RAM £360.00

ACCESSORIES

Radio Shack Phone Modem £160.00
UHF Modulators (encased with leads for 625 lines) £20.00
RAM upgrade (4-16K, 16-32K, 32-48K) supplied and fitted at our premises (Kit £80.00) £85.00
S100 interface for TRS 80 (6 slots) £375.00
£49.00

BASIC SYSTEM

extended basic in ROM - (16K RAM) - video output £750*

ACCESSORIES

Real time clock/calendar card - 1/1000 sec to 388 days with interrupt, software controllable £140.00
Speechlab - provides voice control for the Apple £127.00
Supertalker - adds human speech output! £205.00
ALF Music Synthesizer Card £215.00
A1-02 Data Acquisition Card £170.00
Graphics Tablet P.O.A.
AC Line Controller £270.00
RAM Upgrade (16-32K, 32-48K) £69.00
Hobby Prototype Card £20.00
Romplus - u./c, mixed text/graphics £120.00

BASIC SYSTEMS

Sorcerer 32K RAM (inc. UHF Modulator) £840.00

ACCESSORIES

Exidy S100 Bus with Interface + motherboard PSU £200.00
P.O.A. CP/M for Sorcerer on Disk £145.00

ADVANCED SYSTEMS

Altair, Equinox, Billings, Heath, Rair, Horizon.
Installations include hard disk and multi tasking. Prices on Application.

NEWS

CORVUS 11mb Hard Disk for TRS 80 & Apple. Complete with interface & D.O.S. £3500.00

TANDY Model II now available for demonstration at our Camberley Office. (by appointment only)

P.O.A.

PUTERS ETC

Consultancy and Competitive Prices.

Registered business name



DISKS

PET	
CBM 3040 (dual drive) 343K User storage*	£795.00
Computhink (dual drive) 400K storage	£895.00
Computhink (dual drive) 800K storage	£1145.00
TRS80	
Shugart drive	£315.00
Micropolis drive	£315.00
Percom FD200 drive 110v	£299.00
Micropolis Dual Drive (394K storage)	£395.00
Corvus Hard Disk (11mb)	£3500.00
APPLE	
Apple Drive - 116K storage 1st drive	£398.00
Apple Drive - 116K storage 2nd drive	£355.00
Corvus Hard Disk (11mb)	£3500.00
SORCEROR	
Exidy - 143K storage	£495.00
Exidy Dual drive (630K storage)	£1195.00
Corvus Hard Disk (11mb)	£3500.00

PRINTERS

PET	
CBM 3022 (80 col with PET graphics - tractor feed)*	£675.00
TRS80	
TRS 80 Screen Printer (text + graphics) (110v)	£445.00
New Radio Shack Micro Printer	£245.00
GENERAL	
Teletype 43 KSR Serial (pin or pinch feed, 132 cols)	£825.00
Teletype 33 KSR Serial (110 Baud) Reconditioned	£550.00
OKI - parallel/serial (pin or pinch feed, 80 cols)	£499.00
Centronics 779 parallel (tractor feed, 132 cols)	£825.00
Anadex DP 8000 serial/parallel (112 cps bi-directional tractor feed, 40, 80 cols selectable)	£560.00
Centronics Micro Printer (20, 40, 80 cols selectable)	£395.00
Heath WH 14 serial (80, 96, 132 cols selectable)	£510.00
QUME daisy wheel printers	P.O.A.
TCM100/MICROHUSH Thermal Printer (40 cols) inc. interface for PET/APPLE/TRS80	£266.00

ETC.

Diskettes 5 1/4" (blank) boxed (min order 10) each	From £3
C12 Cassettes (min order 10) each	£0.35p
Ansaback 'phonemate' telephone answering machine, voice operated twin cassette	£190.00
Pace EZ-PHONE - Cordless Telephone	£225.00
Computerizer Speech Synthesis for S100	£350.00
BOOKS	
Large range of microcomputer related books and magazines	
TERMINALS	
Pentland V1, 80 char./24 lines 2 page memory	£580.00

IF YOU DON'T SEE IT - ASK IF WE HAVE IT

SOFTWARE

PET

PETSOFT authorised dealers - over 160 programmes on cassette and disk. Send for catalogue.

STAGE ONE COMPUTERS S/W dealers - PETAID, Stock Control, etc. Send for list. Programmers Toolkit - 10 powerful new commands for your Pet - plug in ROM chip 8K and 16/32K resp

74 Common BASIC Programs on one tape	£75/£55
PETACTION Business Software - Sales and Purchase Ledger	£15.00
CBM DISK-BASED BUSINESS SOFTWARE -	P.O.A.
Commodore Word Processor powerful word processor package	£75.00
CSTOCK - STOCK CONTROL - gives complete stock report	£150.00
CBIS - BUSINESS INFORMATION SYSTEM - Storage & Retrieval of all types of company records	£150.00
(We are authorised CBM Business Software Dealers)	
JOYSTICK PACKAGE - complete with connector software	£25.00
CAR INSURANCE QUOTATIONS - computerised car insurance quotation suitable for insurance brokers (TVJ S/W)	£25.00
MORTGAGE QUOTATIONS - suitable for agents/mortgage brokers (TVJ S/W)	£25.00

TRS 80	
COMAC III SUITE - computerised accounting for TRS 80 (TVJ SOFTWARE)	£75.00
STOCK CONTROL - complete inventory control - recorder level - P/O's etc.	£115.00
CP/M	£95.00
CBASIC	£75.00
FORTRAN includes compiler, relocatable assembler text editor and linking loader	£85.00
PASCAL - tomorrow's programming language today	£195.00

ELECTRIC PENCIL - powerful word processor allows full cursor movement, insert/delete, string search block movement, adjustable line length, justification on cassette

ELECTRIC PENCIL as above - disk version	£115.00
LOWER CASE MOD KIT for Electric Pencil	£28.00
DATA MANAGEMENT/REPORT GENERATOR - easily formats disk files, allows entry, edit, delete and list of records and retrieves data for display or calculation on screen or printer	£200.00

RSM-2D DISK MONITOR - powerful system manipulates disk data, has Z-80 break/define

ISAM - INDEX SEQUENTIAL ACCESS METHOD - sub routines to facilitate control of random data files	£25.00
ST80D communications software	£45.00
NEWDOS - TRSDOS with corrections and enhancements	£60.00
NEWDOS - as above but with further facilities:-	£25.00
KBFX, Renum, Screen to printer in one step, DOS commands from BASIC, Level 1 in II, Superzap, Disassemble, load and save faster, list variables	£49.00

LIBRARY 100 - an assortment of 100 programs	£38.00
SARGON CHESS - 16K Level II - the 1979 Champ Version I	£14.00
SARGON CHESS - 16K Level II - the 1979 Champ Version II	£24.00

APPLE

EASYWRITER - word processing system	£85.00
A2FP FUNCTION PLOTTER - Comprehensive graph plotting	£18.00
PILOT - programming language suitable for educational purposes	£35.00
U-DRAW II - High Resolution graphics editor. Create a figure then intake, expand, contract etc and store on disk	£27.00
PROGRAMMERS AID No. 1 - Plug-in ROM gives numerous facilities including renumber, merge, high res in integer etc	£29.00
3D GRAPHICS - High res plotting in 3D!	£30.00
LISP - programming language suitable for research in artificial intelligence	£30.00
3-MILE ISLAND - Complex disk based game simulating nuclear reactor	£27.50

MUSE authorised dealers. Many programs on cassette and disk. Send for list.

SORCEROR many programs available - send for list.

COMPUCOLOR full lists available.

* 5% DISCOUNT ALLOWED FOR EDUCATIONAL ESTABLISHMENTS



T&V JOHNSON (MICROCOMPUTERS ETC) LTD

Hours of business

Mon-Fri. 9.30 - 5.30

Sat. 9.30 - 1.00

Member of the TV Johnson Group of Companies

Camberley (Head Office)

165 London Road, Camberley

Surrey, GU15 3J5.

Telephone (0276) 62506

Oxford

148 Cowley Road, Oxford

OX4 1JL

Telephone (0865) 721461

Bristol

48 Gloucester Road, Bristol

BS1 6BH

Telephone (0272) 422061

+ Ansaback evens

and w/ends.

Telex 858893



PRICES EXCLUDE VAT, FREIGHT & HANDLING SEND OR

PHONE FOR PRICE LIST & BROCHURES

(All prices correct at time of compilation)

Directors: Dr. R.V. King BA, MIEE
S.G. Johnson, BSc (Hons.)
T.S. Johnson, ABIBA, ACMB, FBCB, MBIM
A.S. Barton ACI, ABIBA, CIdfAP

Branches at:
Birmingham, Bristol, Edinburgh, Leeds, London, Louth,
Newmarket, Nottingham, Oxford, Byfleet, Wokingham.

PO Box 2
St Neots
Cambridgeshire

Dear Sir

The benefits of word processing are here for all!

The **Comart VDM** Video Display Module plugs easily into the North Star Horizon Computer S100 Bus and, together with the Comart Monitor and VDM *Star word processing software, provides the facilities of "instant display" word processing on a general purpose microcomputer.

Text may be entered, edited and standard paragraphs inserted with true upper & lower case display then rapidly printed in your chosen format.

The VDM transforms the Horizon into a valuable word processor yet change the diskette software and it resumes its role as a general-purpose Computer **Real Flexibility!**

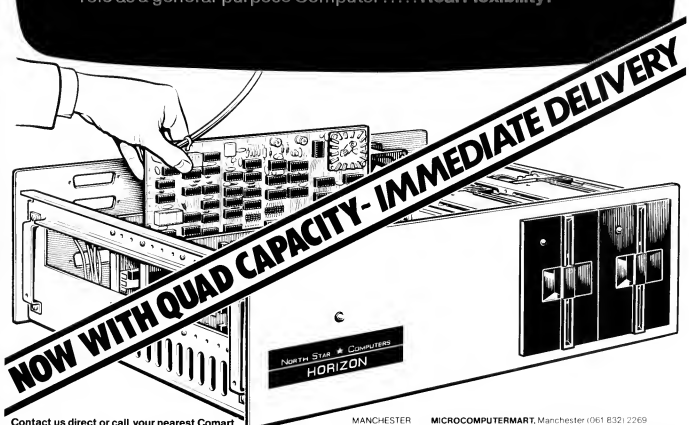

Contact us direct or call your nearest Comart dealer

CAMBRIDGE
CAMBERLEY
ILFORD

LEEDS

LONDON
LUTON

CAMBRIDGE COMPUTER STORE, Cambridge (0223) 68155
MICROBITS, Camberley Surrey (0276) 34044
THE BYTE SHOP, Ilford Essex 01-564 2177
also at Tottenham Court Road London 01-636 0647
HOLDENE LIMITED, Leeds (0532) 459459
also at Wilmslow Cheshire (0625) 529486
DIGITUS LIMITED, London W1 01 636 0105
ISHERWOODS, Luton Bedfordshire (0582) 424851

MANCHESTER
NEWBURY
NEWPORT
NOTTINGHAM

SHEFFIELD
SOUTHAMPTON

MICROCOMPUTERMART, Manchester (061 832) 2269
also at West Park Leeds (0532) 786466
NEWBEAR COMPUTING STORE, Newbury Berks (0635) 30505
also at Stockport Cheshire (061 491) 2290
MICROMEDIA SYSTEMS, Newport Gwent (0633) 50528
COMPUTERLAND LIMITED, Nottingham (0602) 40576
also at Birmingham (021 622) 7149
Manchester 061-236 4737
Glasgow (041 332) 2468
HALLAM COMPUTER SYSTEMS, Sheffield (0742) 663125
TITAN SYSTEMS LIMITED, Southampton (0703) 38740



comart specialists in microcomputers

Comart Ltd., P.O. Box 2, St. Neots, Huntingdon, Cambs, PE19 2AF. Tel: (0480) 215005 Telex: 32514



XITAN SYSTEMS

LOOK AT THESE
NEW PRICES*

CROMEMCO SYSTEM 3

£4,054.00 for this system with vdu.

The ideal business system. System includes a full 64K fast RAM, dual full-size floppies (Persci 277), RS232 interface/20mamp loop for console device, parallel printer port (Centronics/Anadex compatible), 21 slots for expansion, Lear Stesler 24 lines or 80 chars vdu, and ... CROMEMCO's CDOOS operating system with their 14 digit BCD extended disk Basic — ideal for those accurate large numbers required by successful businessmen. CDOOS is CP/M functionally equivalent, with many extra facilities. Optional extras from Xitan include Fortran, Cobol, Text Formatting, Z-80 macro-relocating assembler and DBMS at £59.00 each. CIS interactive screen handling Cobol at £425.00 (recommended to serious business users). Cromemco S100 boards, CP/M (we are an authorised oem distributor of Digital Research's CP/M) for the System 3, Wordmaster, Wordstar, Supersort, and CPM374X utilities.

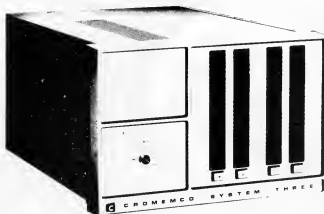

COMING SOON! ... Full 7-terminal multi-user operating system from Cromemco for System 3 users. Up to 48K per user, all running independently. This operating system has to be seen to be believed. It will run any of the Cromemco provided and supported software packages, in any combination. Features include partition rescue facilities, allocating more memory to users, real-time clock for time/date stamping of jobs and disk queuing techniques. Buy your System 3 now, expand later as you need it.

S100 BRITISH COLOUR BOARD

We are proud to offer the first BRITISH S100 Colour board. Manufactured by a local Southampton company — Hi-tech, we can thoroughly recommend this product. Features include true PAL colour generation for high-definition on your television or colour monitor, 15+ colours and black/white with 6 additional grey scales, 24 lines with 40 characters per line, with standard character set plus 44 numbers and symbols, and 64 computer selected graphics symbols. Symbols include fractions and the E symbol. Plotting is available at 80 x 72 resolution. Single or double-height characters, with flashing on an on/off duty cycle of 3-1. The board is memory mapped on any 2K boundary, with its I/O port set at any of the 256 available on the S100 bus. Just plug into your S100 system and colour television and go! Driver software and documentation provided. Price £295.00ex vat cash with order. Please specify if for television or 75 ohm monitor.



ON DEMO NOW! The Cromemco Z2-H.

For only £4,995.00 set the reliability and quality of Cromemco, coupled with the capacity of the new IM1 11 megabyte hard disk drive. This is incredible value for money. Specification includes transfer rates of up to 10 times faster than the fastest standard floppy disk, DMA controller for up to 7 hard disk units, and the new extended CDOOS operating system. Systems available in three configurations: — A) The Z2-H complete integral system, 64K RAM, Z80A cpu, two double-sided mini-floppies, RS232 console port, parallel printer port, power supplies, cables, case and 12-slot S100 motherboard (7 slots free). B) Additional hard disk subsystem for existing system 2 or system 3 users consisting of one hard disk, DMA controller, power supply, case and cable. C) As unit B but with two hard disks. Prices: Unit A) £5,380.00
B) £4,330.00
C) £7,420.00

Xitan Systems also supplies and stocks vdu's, printers, NORTH STAR HORIZON computers, Commodore Business Machines PETs, S100 boards, and books. We are here to demonstrate the range of quality microcomputer systems available for use today. Ring up for an appointment now! You'll not be disappointed. We have Osborne's Sales Ledger and Payable Ledger in source form for use on Cromemco System 3 with CBASIC2, and we can offer a customising service on these programs. Additional software includes Microsoft Basic Interpreter and Compilers, Cbasic, Macro80, and CP/M for the North Star Horizon.

Xitan Systems Ltd., 23 Cumberland Place, Southampton SO1 2BB.

Tel: (0703) 38740

Hours Tue-Sat 9.30 am to 5.30 pm

TANDY

NEW LOWER PRICES ON THE TRS 80

**OVER
100,000
SOLD**



TRS - 80 Model I
4K Level I
£385.25
inc. vat.
£335.00 plus vat.

TRS - 80 Model I
16K Level II
£546.25
inc. vat.
£475.00 plus vat.

**Meet TRS-80's Big Brother!
The new TRS-80 Model II.**

Level refers to version of BASIC language.
Level I is a beginners' language.
Level II is very advanced. Level and memory
can be expanded. All systems include Users
Manual and game cassette.

For Business, Learning and Entertainment

Just think what the incredible TRS - 80
microcomputer could do for your family or
business.

The TRS - 80 will take you into the world of
tomorrow for less than the price of a set of encyclo-
pedias and it can free you from routine tasks that
waste so many valuable hours

Properly programmed, it can help with your
budget, manage your mailing list or teach children
maths.

And, when the work is finished you can spend
many enjoyable hours playing one of several
pre-programmed games

Visit a Tandy Computer Centre or any of our
180 nationwide stores and dealers for full details.

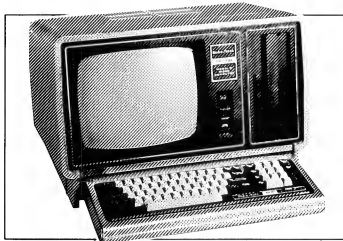

We've added a bigger, more powerful
"brother" to the TRS - 80 family. It's TRS - 80 Model II
— a completely new microcomputer for business
applications

Its capabilities start where TRS - 80 Model I
approaches its upper limits. Order now for delivery
within four-five months

FROM £1,999 plus vat.

(Illustration: Central Processing Unit, Monitor and Disc drive
TRS - 80 Model II)



Wiley

WRITING INTERACTIVE COMPILERS AND INTERPRETERS

by P.J. Brown, Computing Laboratory,
University of Kent at Canterbury

This book differs from the established literature in three ways. First, it deals with interactive languages, which demand different techniques and present different challenges from the traditional non-interactive languages. Second, it is a practical book — it assumes you actually want to implement something, rather than study theoretical concepts; there is, therefore, as much material on planning and performing the task of implementing a language as there is on the underlying theoretical principles. Third, it aims to be a simple book, assuming no more from the reader than an ability to program and a familiarity with interactive working. If you are more knowledgeable, there are some sections you will be able to skip over. (Wiley Series in Computing; Editor: D.W. Barron, University of Southampton)

CONTENTS

Preface:

Part 1: PLANNING: Why Interactive; Planning Use of Resources; Documentation; Designing the Source Language and the User Interface; Encoding the Compiler;

Part 2: THE STRUCTURE OF A COMPILER: Filling the Gaps; Description of Terminology and Environment; Source and Internal Languages; Incremental Compiling; Re-creating the Source Program; Levels of Internal Language; True Compilers; Error Checking; Error Messages; Names, Scope and Data Type; Dictionaries and Tables; Storage Management; The Editor; Input and Output; Break-ins; Summary of Design;

Part 3: THE DESIGN OF AN INTERNAL LANGUAGE: Reverse Polish Notation; Operators; Encoding Reverse Polish; A Brief Summary;

Part 4: THE TRANSLATOR: Overall Translator Organization; Lexical Analysis; Grammars; Using Grammars for Parsing; Checking and Resolving Data Types; Semantic Actions;

Part 5: THE RUN-TIME SYSTEM: Error Detection and Diagnosis; Executing Reverse Polish; Allocating and Referencing User Variables; Execution of Statements; String Temporaries;

Part 6: OTHER MODULES: The Pre-run Module; The Re-creator Module; The Command Module;

Part 7: TESTING AND ISSUING: Testing the Compiler; Issuing; Part 8: **SOME ADVANCED AND SPECIALIZED TOPICS:** Some Special Compilers; Dynamic Compiling; Summary of the Deadly Sins; References; Index.

0471 27609 X 284 pages November 1979 \$26.00/£9.75

PERSONAL COMPUTING: Home, Professional, and Small Business Applications

by D.R. McGlynn, Quark Microsystems Inc.

0471 05380 5 276 pages November 1979 \$13.50/£6.00

John Wiley & Sons Limited
Baffins Lane · Chichester · Sussex · England

CAMBRIDGE LEARNING ENTERPRISES

*Self
Instruction
Courses*

Microcomputers are coming - ride the wave! Learn to program. Millions of jobs are threatened but millions more will be created. Learn BASIC: the language of the small computer and the most easy-to-learn computer language in widespread use. Teach yourself with a course which takes you from complete ignorance step-by-step to real proficiency with a unique style of graded hints. In 60 straightforward lessons you will learn the five essentials of programming: problem definition, flowcharting, coding the program, debugging, clear documentation.



Book 1 Computers and what they do well; READ, OATA, PRINT, powers, brackets, variable names; LET, errors; coding simple programs.

Book 2 High and low level languages; flowcharting; functions; REM and documentation; INPUT, IF...THEN, GO TO; limitations of computers, problem definition.

Book 3 Compilers and interpreters, loops, FOR...NEXT, RESTORE, debugging, arrays, bubble sorting; TAB

Book 4 Advanced BASIC; subroutines, string variables; files, complex programming; examples; glossary

Understand Digital Electronics

Written for the student or enthusiast, this course is packed with information, diagrams and questions designed to lead you step-by-step through number systems and Boolean algebra to memories, counters and simple arithmetic circuits and finally to an understanding of the design and operation of calculators and computers.

Book 1 Octal, hexadecimal and binary number systems; conversion between number systems; representation of negative numbers; complementary systems

Book 2 OR and AND functions; logic gates: NOT, exclusive-OR, NAND, NOR and exclusive-NOR functions; multiple input gates; truth tables; De Morgan's Laws. canonical forms; logic conventions; karnaugh mapping; three state and wired logic.

Book 3 Half adders and full adders; subtractors; serial and parallel adders; processors and ALUs; multiplication and division systems.

Book 4 Flip flops; shift registers; asynchronous and synchronous counters; ring, Johnson and exclusive-OR feedback counters; ROMS and RAMS.

Book 5 Structure of calculator; keyboard encoding; decoding display data; register systems; control unit; program ROM; address decoding.

Book 6 CPU; memory organisation; character representation; program storage; address modes; input/output systems; program interrupts; interrupt priorities; programming, assemblies, computers, executive programs, operating systems.

GUARANTEE - No risk to you

If you are not completely satisfied your money will be refunded on return of the books in good condition.

Please send me:-

... **Computer Programming in BASIC (4 books) @ £7.50**

... **Design of Digital Systems (6 books) @ £11.50**

All prices include worldwide surface mail costs (airmail extra)

IF YOUR ORDER EXCEEDS £15, DEDUCT £2

I enclose a cheque/PO payable to Cambridge Learning Enterprises for £.....

or please charge my Access/Barclaycard

account no.....

Telephone orders from credit card holders accepted on 0480-67446

(Ansafove). Overseas customers (inc Eire) send a bank draft in

sterling drawn on a London bank, or quote credit card and

number.

Name

Address

.....

.....

.....

.....

.....

.....

.....

.....

.....

.....

.....

.....

.....

.....

.....

Cambridge Learning Enterprises, Unit 47, Rivermill Site,
FREEPOST, St. Ives, Huntingdon, Cambs PE17 4BR England.



COMPUTER HOUSE

NOW OPEN
MONDAY-SATURDAY
9.30-5.30

HIGH DEFINITION 9" VIDEO MONITOR

This superb eye care pixel video monitor was especially made as an information display on a large computer system. It features silicon electronics attractive style and a built-in shatterproof two colour A.B. case with controls under flap. 240p output from 825 lines 75 to 50 when composite video input 50 to 30 Hz. Frequency response. Supplied complete or good condition but untested and unguaranteed.

Connect direct to your MPU or only
Supplied complete with circuit **£47.50** p.p. £6.00

DATA STORAGE MEDIUMS

RACAL C10 Super-gate cassettes complete with library cases £60 each 10 for £43.
VERBATIM 5 1/2 soft sector mini disks £3 each 10 for £31.63

OPTO SMASH!

T1L 302/AMN 7 7 segment LED readout common anode direct drive 1/4 inch resolution £1.00 each
T1L 119/OC72 Dartington opto £1.00 each
T1L 305 3 7 segment LED readout £1.00 each
T1L305 3 7 segment LED readout alphanumeric readouts £1.75 each
PHOTO TRANSDUCER Fujitsu OPT 100 NPN silicon 30V 25mA 4 for £1.00

DISPLAY I.C. AND TRANSISTOR BARGAINS NEVER CHEAPER

Well known manufacturers and fully guaranteed. No fall outs. Comprehensive data on I.C.'s 15p per type.
2N4351 N channel MOS FET 2N4352 P channel MOS FET 50p each 10 for £3.00
HIGH VOLTAGE NPN POWER SWITCHING transistors BV80 600V BV800 500V Bivolar 1/2 Ic 2 amps. Pk 125 watts HF 60 Hz 2.5 mhz lead inductors etc. T03 E1 60 each 4 for £5.40
BF255E NPN 25V @ 200ma 45p each 3 for £1.00
1R 1B595 1.2 amp 100V bridge rec 10p each long leads 4 for £1.00
1N4998 4 amp 30V P.C. mount diode long leads 14p each 10 for £1.10
LM309K 5 x 1.2 amp regulator £1.10 each 4 for £5.35
2N1871 B unijunction 450ma 30V 40p each 10 for £1.00
1R 12 AMP BRIDGE RECS 400 volt 1/2 25 each
POWER DARLINGTON SCOP:
MULLARD MPR 65x 2 amp 102 75p each
2N635 PNP 80V 100mA 100 1/2 25 each
MULLARD MPR 35x 150mA 100 1/2 25 each

4k x 12 RAM static Memory card

Complete 4k x 12 memory system on one PCB. This computer memory card carries all relevant decoding read write and control logic for coupling to your MPU or micro-computer system. It can also make interfacing a task. We understand that by reading the manual can be organised as a 4k x 12 features include: 128 words of memory access time. Standard +12V -12V 5V power rails compact construction non volatile memory. data remains even when power switched off! Original cost over £100 each. Supplied complete with full data and circuit manual at an unbeatable price of
£39.95 p.p. £7.75
Note: Memories are removed from working equipment but supplied untested unguaranteed.

HOW TO GET HERE

Victoria, London Bridge or Holborn Viaduct to Thornton Heath 1 minute from Thornton Heath Station

MPU EXPERIMENTORS POWER SUPPLY

Once again we are very pleased to offer this superb Power Supply Unit, and hope to satisfy most of our previous customers who were disappointed when we sold out due to demand. Last time we were advertised! These units may just have well been made for your lab, they consist of a semi-enclosed chassis measuring 150mm x 100mm x 350mm containing all silicon electronics to give the following fully regulated and short circuit proof outputs of +5v @ 2amps D.C. +12v @ 800ma D.C. -12v @ 800ma D.C. +24v @ 350ma D.C. and if that's not enough a fully floating 5v output and a 5v @ 200mA D.C. which may be altered to give other voltages. All outputs are brought out to the front panel via miniature quick socket and are also duplicated at the rear on short flying leads. Units accept standard 240V AC mains input. They are GPO and may have minor scratches on the front panels, they are sold untested but in good internal condition. Our original price of £116.50 and the recent VAT increase makes these an absolute snip at only **£115.50** each + 12.25 P.P. Complete with circuit and component list.

HURRY WHILE STOCKS LAST!

HY GRADE SMOOTHING CAPS
MULLARD PLESSEY ALLIORY SPRAGUE
1500mf 100 60p 3300mf 40 50p
3300mf 63V 70p 1mf 600mf 1MVAR 28p
10000mf 15v 1/4 22000mf 16L 100 200mf
1000mf 250 45p 21000mf 100 200 45p
*Equipment tested **P.P. 40p

SEMICONDUCTOR 'GRAB BAGS'

Amazing value mixed semiconductors, include transistors, digital, linear, I.C.'s, tracka, diodes, bridge recs. etc. etc. All devices guaranteed brand new, full spec, with manufacturers markings, fully guaranteed.
50 + BAG £2.95 100 + BAGS £5.15

MUFFIN FANS

Ideal equipment cooling etc tested, as equipment.
240V 50 60 HZ 15V p.p. 45p
110V 50 60 HZ 15V 08 45p

ELECTRONIC COMPONENTS & EQUIPMENT 66% DISCOUNT

Due to our massive bulk purchasing programme which enables us to bring you the best possible bargains, we have thousands of I.C.'s, transistors, Relays, Caps, P.C.B.'s, Sub assemblies, Switches, etc. etc. surplus to our requirements. Because we don't stock sufficient stocks of any one item, we include in our ads, we are packing all these items into the "BARGAIN PARCEL OF A LIFETIME". Thousands of components at giveaway prices. Guaranteed to be worth at least 3 times what you pay plus we always include something from our ads for your valuable value. Sold by variety.
71b £ 5.25 140b £ 7.95
281b £13.75 561b £22.00
PLEASE ADD P.P. £1.25

ISOLATED 240v 4 AMP @ 10 AMP SOLID STATE RELAYS

Introduce your MPU etc, with the outside world safely by the famous "Antra" range of 10 amp miniature plastic module with mounting holes containing a ready relay for isolation, choke and inductor D.C. at a few millivolt ripple on off control of A.C. loads up to 10 amp! The 10 amp version should be mounted on a heatsink. 100's of fully featured power control, lighters, etc. etc. Dimensions: 4 amp, 11 x 1 1/2 x 10 amp, 11 x 1 1/2 x 4 amp £1.45 10 amp £2.10 complete with circuit

PLESSEY EDGE STACKABLE DECADE THUMBWHEEL SWITCHES

Gold plated contacts dimensions 2 x 2 x 1/8 85p each for £5.35
26 way B 156 double sided edge connector, rotary cut £1.25 each
AMPHENOL 501 BNC plug 50p 501 BNC plug right angled 60p
C90 Audio Cassettes super type construction 45p each 3 for £1.00
BuBa 24v 14 watt white frosted S.B.C. 8 for £1.00
BuBa 12v 100 watt black similar S.B.C. 45p each
S.B.C. Bulb Holders All steel cast plated panel mount easily fixed via nut and round hole, ideal disco displays, scoreboards, etc. 4 for £1.10
Xtal filter S.C. 1/OC1211 B miniature low insertion loss P.C. mount
Dynamic Stick Mica 6001 with built in on/off switch complete with lead and rivet jack plug £1.15 each 10 for £10.00
TOS HEATSINKS "Thermally" black anodised press on aluminium junction type 16p each 8 for £1.00

HARDWARE PACK

Don't stick for the right nut and bolt for the job. Pack contains: 8 A. Metric Unified Self Tap etc. Nuts, Bolts, Screws, Washers, etc. in Brass Bronze and Steel All steel items plated. Average contents 400-800 pieces. Sold by weight, **£2.65** 2lb bag

MANY HUNDREDS OF TRANSFORMERS IN STOCK - SEND SAE FOR LIST

ONLY FEW LEFT
8 1/2 inch Floppy disc drives £5.00 @ VAT
Phone for further details

TELETYPES
KSR33 20ma loop from £150.00
ASR33 20ma loop from £275.00

SCOOP OF THE YEAR HAZELTINE H100 V.D.U. TERMINAL

Due to a fantastic bulk purchase, we are now able to offer this superb terminal at a price almost below the cost of manufacture! Features include: 12" screen, 55 key TTY keyboard, full ASCII, RS232 interface, adjustable baud rate 75 to 9600, 12 lines x 80 characters (upgradable to 24 x 80), cursor control, lower case option, plus many other features.

Brand new at only **£250** CASH + VAT.
FULL Technical Manual available

POWER SUPPLY UNITS

5 VOLT 2.5 AMP T.T.L. P.S.U.
Made for T.T.L. this compact electronic computer systems unit features a 10 amp transformer with D.C. outputs of 5 volts @ 2.5 amps and 2.5 volts @ 5 amps. The 5 volt output is fully regulated and smoothed and has electronic current limiting. Max. earth to metal for 5 volts is 75 amps, but even working but untested. 240V A.C. input complete with circuit.
£8.25 P.P. £1.60

KEYBOARD



A special bulk purchase enables us to offer the above standard at a lower net price. 49 codes were included into a direct TTL compatible. 76 output Features such as delayed stroke, 5 volt DC single rail operation and rollover protection make this an absolute must for the IBM compatible computer with connection diagram and edge connector at a secondhand **£20.00** + P.P. £1.60 "no time to test" price only.

SUPER CASE VERSION Same as above spec, but housed in attractive two tone moulded, thin standing case. Unit also includes an all TTL capable 50 pin D.C. connector. **£27.50** + P.P. £1.85
Note: super case version matches B video monitor

VMSO POWER FETS
Latest technology from the SILICON IX VMSO POWER FETS at a major saving over Capital Equipment. 2 amps D.C. @ 100V D.C. - 200 MHz super smooth, derived direct from VMSO, £150 each, 10 for £1250, full application data 20p

HIGH SMITHS RADIAL BLOWERS

Are your hot parts sweating? Then keep them cool with our high speed radial blowers. Made by Smiths, designed for continuous use, in expensive electronic equipment very powerful and quiet, gives massive air flow, proportional to connection diagram and edge connector. Easily mounted, air aperture 2 1/2 x 3. Ideal linear etc. Please state 24 or 110v operation. 50hr only.
BRAND NEW £4.55 P.P. £1.10

TELEPHONES

Dept. P.C.W., 64 766 Melford Road, Thornton Heath, Surrey Telephone: 01-689 7702
Unless otherwise stated all prices inclusive of VAT. Cash with order. Minimum order value £2.00. Prices and Postage quoted for UK only. Where post and packing not included please add 30p per order. Heavy second order a minimum £10.00. Export and trade enquiries welcome. Orders despatched same day where possible. Access and Barclaycard Visa welcome.

Philips Mini-Digital Cassette Recorder.

CASSETTE RECORDER

The Mini-Digital Cassette Recorder (Mini-DCR) can operate in the following modes: Idle, Read, Write, Backspace and Rewind. Complementing the quality and reliability of the Mini-Digital Cassette Recorder are Philips mini-cassettes certified for digital data recording applications. These mini-cassettes use tape which is certified for freedom from drop-outs. Mini-cassettes have been widely used for program loading in Philips office computers during the last four years, and over half a million are already in service. Low cost, low power consumption and compact size of the Mini-Digital Cassette Recorders mean they are ideal for program loading and updating applications as well as providing a highly convenient data capture facility.

Ample capacity for program loading and data interchange is provided by the 128 k byte capacity, and the high data transfer rate of 6000 bits/sec allows quick reading and writing of programs and data.

PRICES INCLUDING MANUAL
 MINI D.C.R. £95 ea. + VAT
 INTERFACE £37.50 ea. + VAT
 INCLUDE £2.25 FOR CARRIAGE ETC.

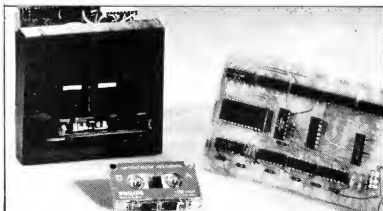

INTERFACE BOARD

This compact interface board was designed specifically for the purpose of interfacing the Philips Mini DCR to a Micro-computer. CMOS logic is used to keep power consumption very low, enabling it to be powered from the micro-computer that it is serving. Flexibility of the system was held as paramount, address decoding can be changed simply by moving links.

By using subroutines held in the micro-computer to control the system the user can make his controlling program to suit his own particular needs and can be as simple or as complicated as necessary.

CURRAH

COMPUTER
 COMPONENTS

79 Crowland Rd. Hartlepool Cleveland.
 TS 24 2 JN. Phone 0429 / 871900

apple

APPLE II EUROPLUS 16K	£790.00
DISC DRIVE WITH CONTROLLER	£398.00
DISC DRIVE WITHOUT CONTROLLER	£395.00
16K ADD ON MEMORY	£ 69.00
HITACHI 9" BLACK & WHITE MONITOR	£127.00
EUROCOLOUR CARD	£ 69.00
PASCAL LANGUAGE CARD	£296.00
ALP MUSIC SYNTHESIZER CARD	£215.00
TCM 100 SILENT 40 COLUMN PRINTER	£243.00
TCM 100 SILENT 80 COLUMN PRINTER	£395.00
TCM INTERFACE FOR PET OR APPLE	£ 49.00

FROM

adda

Adda Computers, 17-19 The Broadway
 (between W.H. Smith and Burtons),
 Ealing, London W.5. Tel. 01-579 5845
 Open 09.00-18.00 Monday to Friday; 10.00-16.00 Saturdays.

Erase Eproms in 8 minutes for under £100

£97 delivered in U.K.
 + V.A.T.



The high speed, high capacity model UVB sets new performance and price standards.

- Cuts typical erasure times by a factor of 5
- 8 MINUTE SOLID STATE TIMER
- Capacity up to 14 EPROMS
- 2708 type erased in 4 to 7 minutes
- High intensity 254 NM UV source
- Safety interlock automatically starts timing sequence
- Audio tone signals erasure cycle complete
- Internal switch to extend erase time.

MICRODATA Computers Ltd, Belvedere Works, Bilton Way,
 Pump Lane Industrial Estate, Hayes Middlesex.

Telephone (011 848 9871) (6 lines) Telex 934110

IF YOU'RE CONSIDERING A MICROCOMPUTER

Be Sure to Check Out the Product Offerings of the World's Largest Full Line Microcomputer Company.

All Ohio Scientific machines come with microcomputing's fastest full feature BASIC-in-ROM or on-Disk for instant use.

Challenger I Series

Economical computer systems that talk in BASIC.

Ideal for hobbyists, students, education and the home.

	Minimum Configuration	Base Price
Superboard II - World's first complete system on a board including keyboard, video display, audio cassette, BASIC-in-ROM and up to 8K RAM	4K RAM	£ 188
Challenger IP - Fully packaged Superboard II with power supply	4K RAM	£ 238
Challenger IP Disk - Complete mini-floppy system expandable to 32K RAM	16K RAM	£ 865

Challenger IIP Series

Ultra high performance BUS oriented microcomputers for personal, educational, research and small business use.

C2-4P - The professional portable	4K RAM	£ 404
C2-8P - The world's most expandable personal machine for business or research applications	4K RAM	£ 548
C2-4P Disk - The ultimate portable	16K RAM	£1050
C2-8P Single Disk - Ideal for education, advanced personal users, etc.	16K RAM	£1199
C2-8P Dual Disk - Most cost effective small business system	32K RAM	£1790

Challenger III The Ultimate in Small Computers

The unique three processor system for demanding business, education, research and industrial development applications.

C3-S1 - World's most popular 8" floppy based microcomputer	32K RAM dual floppys	£2334
C3-OEM - Single package high volume user version of C3-S1	32K RAM dual floppys	£2334
C3-A - Rack mounted multi-user business system directly expandable to C3-B	48K RAM dual floppys	£3403
C3-B - 74 million byte Winchester disk based system. World's most powerful microcomputer	48K RAM dual floppys	£8654
C3-C - 29 million byte Winchester disk based system.	48K RAM dual floppys	£6320

Full Business and Data base Software

OS.AMCAP - A complete small business accounting package including inventory, invoicing, A/R, A/P, CR, CD, general ledger and P/L	£ 556
OS.DMS - Data base Management System designed specifically for small business information management.	£ 175
- DMS based modules for Inventory/order, A/R & A/P, General Ledger, personnel/payroll, Query, Word Processing.	£ 175 each
WP-2 - Complete word processing system with character justification, global editing, paging, text justification, proportional spacing and hyphenation.	£ 116

OHIO SCIENTIFIC also offers you the broadest line of expansion accessories and the largest selection of affordable software!

Compare the closest Ohio Scientific Model to any other unit you are considering. Compare the performance, real expansion ability, software and price, and you will see why we have become the world's largest full line microcomputer company.



Ohio Scientific now offers you the world's most expandable personal computer system.

The C2-4P is a professional portable microcomputer system. It features a built-in keyboard, video display, and audio cassette. It is expandable to 32K RAM and includes BASIC-in-ROM for instant use.

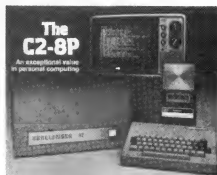

The C2-8P is an exceptional value in personal computing.

The C2-8P is a professional portable microcomputer system. It features a built-in keyboard, video display, and audio cassette. It is expandable to 32K RAM and includes BASIC-in-ROM for instant use.



The C3-B is the world's most powerful microcomputer system for small businesses.

The C3-B is a rack-mounted multi-user business system. It is directly expandable to C3-B and includes 74 million bytes of Winchester disk storage. It is the world's most powerful microcomputer.

I'm interested in OSI Computers. Send me information on:

Personal Computers Small Business Computers

Educational Systems Industrial Development Systems

Name _____

Address _____

Phone _____

MICROCOMPUTER BUSINESS MACHINES
4 Morgan Street,
London E3 5AB
Tel: 01-981 3993

WE ARE LOOKING FOR DEALERS THROUGHOUT EUROPE
PHONE MARK STRATHERN ON 01-981 3993

SOLVE YOUR BUSINESS PROBLEM WITH A MICROCOMPUTER

We have a variety of microcomputers and available software to suit most types and sizes of Business Applications.

At the lower end of the market is the popular TRS-80 (more than 100,000 sold last year). This is a reliable, effective and versatile business microcomputer. Processing speeds and disk storage are more than sufficient for many business applications.

The word processing (using **THE ELECTRIC PENCIL**, is excellent. We also distribute the **TRIDATA** range of business packages (software written by professionals).

WHY PAY MORE?, if the **TRS-80** will do the job.

But if you require a machine with extra capacity, we have suitable systems available.

We would be pleased to discuss your particular requirements with you.

Katanna Management Services Ltd

kms

(In association with S. J. Trott Ltd.)

22 Roughtons,
Galleywood,
Chelmsford,
Essex, CM2 8PF
TEL: (0245) 76127

(member of the computer retailers' association) (TRS-80 is a TANDY' trademark)

ENTERPRISES

A FEW OF OUR BOOKS

Payroll with Cost Accounting	£10.85
Accounts Payable and Accounts Receivable	£10.95
General Ledger	£10.95

all books by Lon Poole and Mary Borchers

BASIC has become the accepted and most widely used language in the microcomputer industry. Osborne & Associates has published a series of books which provide complete source listings for BASIC business programs, complete with detailed user documentation.

The programs published are Payroll with Cost Accounting, Accounts Payable and Accounts Receivable, and General Ledger. Each book includes complete source listings, file layouts, file maintenance programs, interactive operator date entry sequences, screen display formats, and report printout formats. Every program is accompanied by user instructions, program flowcharts and narrative descriptions. All programs feature interactive data entry with easy correction of data entry errors. The programs have been made as close to error-free as possible.

Payroll with Cost Accounting features:

- separate payrolls for up to 10 companies
- job costing (labour distribution)
- check printing with full deduction and pay detail
- 16 different printed reports

Accounts Payable and Accounts Receivable features:

- accounts payable check printing with invoice detail
- accounts payable invoice aging
- automatic postings to general ledger
- accounts receivable progress billing
- accounts receivable partial invoice payments
- accounts receivable customer statements

General Ledger features:

- accumulation of postings from accounts payable and receivable
- trial balance
- income and expense statement
- balance sheet

Room PW/D Barking
8 Cambridge House Essex IG11 8NT
Cambridge Road Tel: 01-591 6511

MAGAZINE SUBSCRIPTIONS

For practical applications and discussion on areas of interest, subscribe to one of the Micro Magazines. Buy just one copy to see, if you're not sure. The magazine range from those suitable for the interested newcomer, to those who are software or hardware orientated, as well as those who are generally interested or specifically so. For our range of magazines, please send S.A.E.

SOFTWARE (Selected from our full list)

CP/M	from £65.00	A Multi-User System	£32.00
Whatsit	from £50.00	for Northstar users.	
Electric Pencil:		C BASIC	£65.00
a) SSII for TTY etc	£159.00	Inventory: 1, on Northstar	
b) TRS-80 Cassette	£65.00	disc	£50.00
Word Master	£90.00	Inventory: 2, on Northstar	
Tex Writer	£45.00	disc	£125.00
Word Star	£260.00	Mail Room, on Northstar	
Supersort	£125.00	disc	£50.00
Sales Ledger	£395.00	Housekeeper, on Northstar	
Purchase Ledger	£455.00	disc	£35.00
Nominal Ledger	£495.00	Preventative maintenance,	
Analysis	£130.00	on Northstar disc	£75.00
		NAD (Name & Address	
		system)	£50.00
		QSORT (Sort Utility)	£50.00
		Multi-user, Multi-tasking	
		operating system for	
		Z80	£150.00

HOW TO ORDER

Send cash, cheque, P.O. or credit card no. to the above address. Payment must be in sterling and drawn against a U.K. bank. Telephone orders (with credit card), enquiries or visits welcome. Send S.A.E. for our complete range of books, magazines & software.

SP

DPS.1

MIDAS S.100 SYSTEMS

Substantial Mainframe to house your S100 system, with optional 5" or 8" disc drives. Special systems built to your requirements from Z80 CPU and other S100 boards held in stock

Mainframes from £228

MIDAS 1 : Z80 System from £625

MIDAS 2 : Z80 Disc System from £1100

MIDAS 3 : Z80 Disc System 8" from £1350

DOUBLE DENSITY recording available on MIDAS giving up to 2M BYTES of on-line storage. Software for MIDAS includes CP/M, FORTRAN, COBOL, PASCAL and several BASICS including XYBASIC for control applications.

Board Kits — All available as built & tested boards

Z80 Starter Kit, featuring on board Key-board, 2K Monitor, 1K RAM, 2x8 bit I/O Ports, Prom Programmer etc. etc. £145.00

Z80 CPU, 2MHz, 1K RAM, up to 8K EPROM, Serial/Parallel I/O port, four channel counter timer — SBC 100 £135.00

Z80 CPU Board, 4 MHz, Jump-on-reset £116.00

8080 CPU Board, jump-on-reset £87.00

8K RAM Board, low power 450 n Sec (21L02-1) £79.00

16K RAM Board, low power 250 n Sec Static A/T £195.00

Dynamic RAM Board for 16-64K RAM (4116) £85.00

2708 EPROM (16K) for 2708 or 2716 EPROMS A/T £63.75

2708/2716 EPROM Prog Board, 2 Textool sockets £86.50

I/O Board, 2S/2P, with DIP switch selection £95.50

I/O Board, 2S/4P, provision 4K RAM/4K ROM £135.00

Video Interface, 16 lines, 32 or 64 ch/line (60 frames) £91.00

Video Interface, 16 lines, 64 ch/line (50 frames) A/T £108.75

Video Display, 80 ch x 24 1, keyboard interface 2K RAM, 256 available characters etc £180.00

Motherboard (13 slot with four edge connectors) £48.50

Motherboard (9 slot with four edge connectors) £40.00

Bare Boards — Available for most of above kits

Floppy Discs

SHUGART SA400 Mini Floppy 5 1/4" £190.00

Dier Drive

SIRTON PRODUCTS

13 Warwick Road, Coulsdon, Surrey, CR3 2EF
Telephone : 01 - 660 5617

Professional versatile computer system with comprehensive front panel facilities and 20-slot motherboard. Units have substantial power supply etc. and come with 2 or 4 MHz Z80 CPU. BUS conforms to the IEEE S100 standard.

DPS.1 from £695

Available with K2 operating systems & PASCAL/Z. Companion Disc Drive Enclosure for on-line storage for 250K Bytes to 2 M Bytes.

MIDAS



SILEMENS 120 8" Disc Drive	£325.00
YE DATA 8" Double Sided, Double Density Disc Drive	£450.00
Disc Controller, 5" or 8"	£90.00
Double-Density Disc Controller A/T	£280.00

Hardware	
EPROM Eraser (240V) : Erases up to 12 EPROMs at a time	£42.00
S100 Edge Connectors, solder tail	£2.45
S100 Edge Connectors, Gold plated wire wrap	£3.50
Transformer Pri 110/240V; sec 8V @ 10 Amp & 25V CT @ 2 Amp	£12.75
Bridge Rectifier 25 Amp @ 50V	£3.75

Software	
CP/M on 8" or 5" Floppy Disc	£64.00
C-BASIC 2	£74.00
Z80 Disc Based Assembler, Linker & Editor	£56.00
Microsoft BASIC V.5.	£155.00
XYBASIC — Extended	£215.00
FORTRAN 80	£205.00
COBOL 80	£325.00
PASCAL	£150.00
PASCAL/Z	£131.25
DISZILOG Z80 Disassembler	£37.00

PERIPHERALS	
12" VIDEO MONITOR green phosphor bonded tube, displays up to 80 ch/24 lines, 50/60 Hz operation	£215.00
PRINTER, Bi-directional Dot Matrix; 112 ch/sec; 96 ch ASCII set, 80 ch/line; 900 ch buffer; RS232C or parallel input	£595.00
KEYBOARD, 56-key Tri-mode ASCII output, with case & edge connector	£68.00
12V DC/DC Converter	£6.00

WRITE OR PHONE FOR CATALOGUE NEW SHOWROOM AT 76 GODSTONE RD, KENLEY (Nr. CROYDON)

AERCO GEMSOFT

APPLE II COMES TO WOKING

Aerco Gemsoft have just opened their new computer division in Woking and invite you to drop in for a look at some real computers: APPLE 2 SUPERBRAIN OHIO SCIENTIFIC MICROSTAR 45

We are official APPLE agents and Southern area distributors for the Intertel Superbrain.

Apple 2 16K (Europlus B&W) Superbrain 64K (Twin Disks) ITT 2020 16K (Colour) Microstar 45 Plus Apple 2 Disk Units From 16K Memory Upgrade Kit Serial/Parallel Interface Card PASCAL Language Card ANADEX DP-8000 Printer 9" Hitachi Monitor 12" Hitachi Monitor Auto-start from Eurocolour Card	£750 £1995 £867 £4950 £356 £69 £110 £296 £570 £132 £210 £40 £69	Send S.O.F. for full catalogue containing over 100 area grants for PET Apps and Exotic Software. Trade enquiries welcome for £2.45b. V.A.T.
Please add 15% VAT to above prices.		

GEMSOFT LTD
27 Chobham Road, Woking, Surrey GU2 1JD
Tel: (04862) 22881

Microcomputer Mail Order



GREAT BRITAIN

All your microcomputer requirements can be bought with confidence by mail order from MICRODIGITAL, one of the largest and longest established computer stores.

Most orders are despatched same day as receipt, if not a note explaining what the supply situation is. If we cannot supply within 30 days we will, on request, make an immediate cash refund.

Access and Barclaycard orders are welcome either in writing or over the phone. Your account will not be charged until the goods are despatched.

Official orders of over £10 are also welcome from bona fide commercial and government organisations.

Our new, glossy 16 page 1980 brochure is now the talk of the industry, write or phone today for free copies by return.



MICRODIGITAL

25 Brunelway Street, Liverpool L3 0B.J. Mail orders to: MICRODIGITAL LIMITED, Liverpool L3 0AB.
Tel: 051-228 0337 (24 hour Mail Order) 051-227 2536 (All other Dept.) FREEPOST (No Stamp Required)

WE OFFER A COMPLETE SERVICE!

When you buy a computer from us — we don't give you the box and wave goodbye.

We realise this is a major purchase for a Company and take the time to find out your requirements, design your computer system and write the software, or if you prefer to write your own, we will always be available to advise you.

You can buy a wide range of fully-documented packages — Word Processing/Purchase & Sales Ledgers/Stock Control/Incomplete Records/Medical Systems/Teaching Programs etc. on Microcomputers such as—

APPLE II from £750 (16K)
A complete business system 48K
Apple, 2 Disk Drives, VDU & Printer £2,500

MICROSTAR from £4,950
Multi-user/Multi-task
1.2/2.4 or 4.8 mb.
A complete system with 2 VDUs & Printer £7,000

ALPHA MICRO from £9,950
From 1 to 32 terminals.
From 10 mb. to 90 mb. disk storage.
16-bit processor, Multi-user operating system.

We stock a full range of VDUs, Printers, Computer Stationery, Diskettes, Disk Boxes etc.

all prices ex VAT.

Come and see us to discuss your requirements and have a demonstration.

MICROSOLVE

Microsolve Computer Services Ltd
3rd Floor, Middlesex House, High Street, Edgware, Middlesex.

M1 junction 4 /20 mins from Central London.

e.g.
LOW COST PRINTERM
matrix printer £695
LEAR SEIGLER
200A matrix printer £1,650
QUME Sprint 5
daisywheel printer £2,115.

THE RESEARCH MACHINES 380Z COMPUTER SYSTEM



THE RESEARCH MACHINES 380Z A UNIQUE TOOL FOR RESEARCH AND EDUCATION

Microcomputers are extremely good value. The outright purchase price of a 380Z installation with dual mini floppy disk drives, digital I/O and a real-time clock, is about the same as the annual maintenance cost of a typical laboratory minicomputer. It is worth thinking about!

The RESEARCH MACHINES 380Z is an excellent microcomputer for on-line data logging and control. In university departments in general, it is also a very attractive alternative to a central mainframe. Having your own 380Z means an end to fighting the central operating system, immediate feedback of program bugs, no more queuing and a virtually unlimited computing budget. You can program in interactive BASIC or, using our unique Text Editor, run very large programs with a 380Z FORTRAN Compiler. If you already have a mini-computer, you can use your 380Z with a floppy disk system for data capture.

What about Schools and Colleges? You can purchase a 380Z for your Computer Science or Computer Studies department at about the same cost as a terminal. A 380Z has a performance equal to many minicomputers and is ideal for teaching BASIC and Cesel. For A Level machine language instruction, the 380Z has the best software front panel of any computer. This enables a teacher to single-step through programs and observe the effects on registers and memory, using a single keystroke.

WHAT OTHER FEATURES SET THE 380Z APART?

The 380Z with its professional keyboard is a robust, hardwearing piece of equipment that will endure continual handling for years. It has an integral VDU interface — you only have to plug a black and white television into the system in order to provide a display

380Z/56K complete with DUAL FULL
FLOPPY DISK SYSTEM FDS-2

£3266.00

RESEARCH MACHINES Computer Systems are distributed by RESEARCH MACHINES LTD., P.O. Box 75, Chapel Street, Oxford. Telephone: OXFORD (0865) 49792. Please send for the 380Z Information Leaflet. Prices do not include Carriage or VAT @ 15%.

unit — you do not need to buy a separate terminal. The integral VDU interface gives you upper and lower case characters and low resolution graphics. Text and graphics can be mixed *anywhere* on the screen. The 380Z has an integral cassette interface, software and hardware, which uses *named* cassette files for both program and data storage. This means that it is easy to store more than one program per cassette.

Owners of a 380Z microcomputer can upgrade their system to include floppy (standard or mini) disk storage and take full advantage of a unique occurrence in the history of computing — the CP/MTM* industry standard disk operating system. The 380Z uses an 8080 family microprocessor — the Z80 — and this has enabled us to use CP/M. This means that the 380Z user has access to a growing body of CP/M based software, supplied from many independent sources.

380Z mini floppy disk systems are available with the drives mounted in the computer case itself, presenting a compact and tidy installation. The FDS-2 standard floppy disk system uses double-sided disk drives, providing 1 Megabyte of on-line storage.

*Trademark, Digital Research.

Versions of BASIC are available with the 380Z which automatically provide controlled cassette data files, allow programs to be loaded from paper tape, mark sense card readers or from a mainframe. A disk BASIC is also available with serial and random access to disk files. Most BASICs are available in erasable ROM which will allow for periodic updating.

If you already have a teletype, the 380Z can use this for hard copy or for paper tape input. Alternatively, you can purchase a low cost 380Z compatible printer for under £300, or choose from a range of higher performance printers.

380Z/16K System with Keyboard

£965.00

Possibly the most cost effective Laboratory Computers in the world.



The Vector Graphic MZ

- *4MHz Z80A CPU
- *48K ram
- *630K Bytes disk storage
- *Serial port and two parallel ports
- *Prom/Ram Board with monitor
- *MDOS Operating system
- *Z80 Assembler
- *Basic Interpreter

Plus a large range of CP/M compatible software including Fortran, Cobol, Macro assemblers etc.

The Vector Graphic System B

- Complete Vector MZ system plus:*
- *Vector Mindless terminal*
- Flashwriter & video board (24 x 80)*
- *Software driver on prom*
- MZOS North Star compatible DOS*
- *CP/M configured by Almarc*

ALMARC
DATA SYSTEMS LTD

906 Woodborough Road, Nottingham. Telephone: (0602) 625035

MICRO CONTROL

— THE INTERFACE EXPERTS

224 EDGWARE ROAD
LONDON W2
Tel 01-402 8842



MICRO CONTROL have been building specialised hardware and writing software, since Apple first came into the country. We can interface you Apple to *anything* with a custom designed card for a reasonable price. We can also provide Business Systems for Apple II and Micro Star to your requirements.

Centronics Printer Card £132.00

Apple disk drive £355.00

with controller crd £398.00

Micro Hush Printer

+ Apple Interface £266.00

Thermal paperroll for Micro Hush

10in b/w monitor

12in b/w monitor

Apple Pascal £289.00

MicroStar £4,950.00

Printers VDU's ITT Apples Software & one-off's P.O.A.

Colour board for Apple. Have your text in colour! Clean

Micro Con. Real Time Clock. Date/Hr/Minute £90.00

8-Channel Mains Controller £140.00

4-Channel Mains Dimmer £175.00

COMING SHORTLY:— Colour for PET and TRS 80

4-Channel A/D cards 12-bit £174.00; 8-bit £116.00

4-Channel D/A 12-bit £149.00; 8-bit £110.00

16K Add In 150ns £58.00

Apple II 16K £810.00

High Speed Serial Card £110.00.

Com. Card £140.00

Integer Firmware Card (inc. Mini-Assembler)

£110.00

Symtec light pen (for Apple) £165.00.

Apple Voice recognition card £165.00.

Micro Products Eprom burner £140.00.

Box of 10 diskettes £30.00.

Lo-res/Hi-Res hires colours £147.00

THE WORLD OF SINTROM

A private exhibition and seminar at the
Institute of Directors' Headquarters in
Pall Mall 12 and 13 February 1980.

COME AND SEE FOR YOURSELF...

our complete range of computers and
peripherals including the very latest
developments in Winchester Technology
and microcomputers. We will demonstrate
a no-nonsense series of practical
software packages on our hardware for
use in the commercial business world.

Ring 0734 85464

for more details **NOW!**



Sintrom Electronics Ltd
Arkwright Road, Reading, Berks RG2 0LS

WHY BUY A MICRO-COMPUTER FROM

PETALECT ELECTRONIC SERVICING LTD.

BECAUSE

- 1) Established company trading since 1971
- 2) Electronic servicing is our speciality
- 3) We have in-house programmers/systems analysts
- 4) We have our own service engineers
- 5) We will demonstrate the PET at your premises
- 6) We can customise the PET to your requirements
- 7) We can arrange finance
- 8) We offer, after the three-month warranty, a service contract from £69.50
- 9) You benefit from our experience of having sold over 450 micro-computers to industrial, educational and business, personal users.
- 10) We specialise in programs and interfaces for weighing applications for average weight control and counting etc.



Petact authorised distributors for central Southern England for the full range of Computhink disc systems (dealer enquiries welcome)

Computhink Old ROM 400K	£795.00
“ New ROM 400K	£795.00
“ New ROM 800K	£995.00
	All + VAT



Large Keyboard PETS in stock 32K PET £795 + VAT 16K PET Ask for delivery on 16 2040 Disc System and C.B.M Printers. Large Extension Keyboard for the PET £89.50 + VAT.

Specialists in applications requiring interfaces for electronic balances (Sartorius, Metler, Oertling, Salter) also instruments like Pye Unicam SP8 100 Spectrophotometre, other interfaces are available by special manufacture.

Stockists for Petact Business Systems (Sales accounting, purchase invoicing, payroll, Stock Control, Nominal Ledger and management information.

A wide range of Printers available i.e. Teletype 43, Anadex C.B.M., Printerm

COMPUTER BOOKS — for professionals, hobbyists, businessmen and newcomers.

ACCESS, BARCLAYCARD

Wel also supply: **Apple II 16K, 32K or 48K**, mini-disk drives, interface cards and software.

If you require any more information or demonstration regarding the PET 2001/8 or any associated equipment, programs, etc., please contact Mr. P.J.A. Watts or Mr. D.W. Randall at:

PETALECT ELECTRONIC SERVICES LTD
33/35 Portugal Road,
Woking,
Surrey.
Tel. Woking 69032/68497

Shop at:
PETALECT
Chertsey Road,
Woking,
Surrey.
Tel. Woking 21776/23637

Newsprint is the place where Guy Kewney reports the happenings of the micro world — read on for product news, rumour, gossip, prediction, speculation and fearless exposés.

BYTEING THE DUST

The computer retail chain — Byte Shop — is dead: long live Byte Shop (1980). The old trading company is in receivership, and a new trading company, Summary 87 Ltd, has taken over the assets. It was under this arrangement that managing director, Bill Cannings, was suspended from duty and replaced as MD by the accountant he himself had appointed six months earlier — Derek Wetherby.

The reason for the appointment of a receiver was that Byte Shop's major backers, becoming anxious about the future of their investment, called in their money. These backers were the merchant bank offshoot, Charterhouse Developments Ltd and United Electronic Holdings Ltd and, according to Charterhouse director Richard Strong, both had invested £75,000.

Having said all that, the list of absolute facts that can be written down on paper becomes very short. Indeed Charterhouse's view of events is quite simple: Byte Shop was insolvent, because it couldn't pay its debts as they fell due.

Talking to people inside the group elicits the widespread opinion that this was only part of the problem. It seems there was a personality clash between Cannings and Charterhouse and it is said that, because he controlled half the shares, any conflict could never be resolved at board level.

What Cannings' style of management may have lacked is still not clear to Cannings himself, but his friends point to the nature of the problem by referring to what they emphasise as his strong point — sales flair and enthusiasm. By implication at least, they suggest that his control of cash flow was "unsophisticated". . . a view supported by his earlier appointment of Derek Wetherby. The crunch came when, depending on your point of view, the company became insolvent, or became "in need of cash to expand".

Part of this expansion was financial. . . credit for the new generation of

customers who were not cash payers. They were local authorities, polytechnics, large companies and they expected to buy and be sent an invoice, and to take their time signing the cheque. And part of the expansion was technical — Cannings had decided to take Byte Shop into software, as he announced last September at the Personal Computer World Show.

It also appears from company figures that there was a problem on maintenance. Say people inside the chain, the problems of servicing the Ohio Scientific range were more than Byte Shop had planned for; a manager of one of their shops has commented that Ohio were slow in supplying components.

Charterhouse has offered the cash needed — another £100,000 — but on terms unacceptable to Cannings, for the simple reason that what Charterhouse wanted, to protect its investment, was control.

Nonetheless, the company is not worthless and prospective buyers are being told to think in terms of £400,000 if they want to buy it. What exactly they might get for their money is not clear. . . certainly they wouldn't be buying the debts. At press time, at least two large groups, one of them Currys, were known to regard this figure as a sensible basis for negotiations.

No one at the Byte Shop (1980) would talk about it, but our guess is that Charterhouse collapsed the old Byte Shop by calling in a debenture (company mortgage). The chain, strapped for capital, was presumably unable to produce the £150,000 needed to pay it off again.

Under the terms of a debenture, Charterhouse could easily appoint a receiver, and this they did; accountancy firm, Stoy Haywood, provided, in the person of a Mr Marriott.

Marriott was instantly put on the spot by the Press, who asked in round terms whether his appointment was, as many in the industry suggested, an attempt to circumvent the claims of creditors. He denied this strongly and Computer Weekly quoted him as saying: "We are doing our best to protect these claims. The

company could be acting criminally if it continued to trade. We have transferred the assets to Summary 87 Ltd, so that the parent company is not trading."

At least one creditor, former publicity man Terry Pettigrew, regards this as ingenuous. "I've been told that if I sue for my money (he's owed around £3,000 worth of fees), Byte Shop — which has no assets at all — will fold and unsecured creditors will get nothing. If we don't sue, then we have been promised a dividend when the company makes a profit, and they say that may not be for two or even three years".

And Pettigrew's opinion of the deal is unique only in his willingness to be quoted: ". . . I may be old-fashioned, but I think that you don't incur new debts until you have paid the old ones, or at least promised to pay them".

The implied conclusion, that Byte Shop may have been undercapitalised but was not going broke, is not based on the figures available to Charterhouse, but on the opinion of unsecured creditors — who are naturally biased. Most of them agree that, for the good of the trade as a whole, it's better that Charterhouse keep the Byte Shop stores going; and they have agreed to continue supplying goods and services to the new company and live in the hope of dividends. It seems that the new company, Summary 87 Ltd, trading as Byte Shop (1980) is transacting business on behalf of the receiver of the old company — and there-

fore the creditors. It can keep cash coming in, whereas the old company is legally prevented from trading.

The \$64,000 question is: if the business is apparently worth somewhere in the region of £400,000, why is it in receivership? Most unsecured creditors will be that much happier when Charterhouse's receiver releases figures — the figures which will show the good reasons for Byte Shop's collapse, beyond the fact that Charterhouse withdrew its finance.

There was no obligation on the bank to keep putting money in. It has acted quite properly as a secured creditor; it was, after all, entitled to demand its money at any stage and leave the company in ruins — and it has not done so. Moreover, as a bank, Charterhouse must protect the interests of its depositors, and this obviously involves putting pressure on the management of a company which it has supported, if that management is causing anxiety.

Obigation or not, it would be a good public relations gesture if Charterhouse were to call a conference and show some figures, and at press time Richard Strong of Charterhouse said he was expecting to be able to show them to creditors "soon". He also said that he couldn't see the unsecured creditors getting £1 in the £1 back. He went on: "I don't know why that's so. . . it simply means that when the company was put into receivership, it was in an even worse state than one thought at the time".



A timetable compiling package from Petsoft: it costs £95, and needs a 32K byte Pet.



"Coo, Bill, I am glad we got this Atari from Ingersoll."
 "Makes you feel fitter at once, don't it Tracey?"
 "Yeh. Stimulates the appetite, this sporting life — but enough's enough."
 "You fancy a quiet, uh, rest darlin'?"
 "Yeh, wot a good idea! You get out the hand-held £17.95 Touch Me game, while I slip out of these sweaty things into sumfink more, you know . . ."

CRA pulls down the Shade

A really useful trade association arises when public outrage at malpractice threatens to close down the business. The most useful trade association is ABTA, which refunds your money if you get taken for a ride by a shyster travel agent; it also finds the criminal and prosecutes him.

Things generally have to be pretty bad before a trade association gets off the ground and, as most of us now know, the computer retail trade has now set up a Computer Retailers' Association (CRA).

Are things really that bad? Are the retailers that desperate? Well, no. Judging by the end of 1979 meeting of the CRA in London, no sense of urgency at all is felt by the retailers of Britain.

One of the prime matters under consideration at the meeting was "a full time secretarial". Having noticed that all the good, grand and grandiose ideas generated since April had come to nothing because there was nobody to carry them out, the CRA approached micro dealer Shade, of Calne, Shade agreed to accept a fee of £7,500 per year, and to provide a full-time secretary, an office, and a consultant. The job was: to chase members and collect their money. All that remained was for the members to agree.

They didn't. First, they thought that an independent person should do the job. When someone rang up Shade asking for the name of a MicroCobol supplier, where, for example was Shade's name to appear on the list? Second, they felt they should

have been consulted first. Third, they felt that a year was too long: a trial period of three months, while other possibilities were considered, would be ideal.

The Shade people were very understanding. They said they understood that they had to provide a telephone — a new one — and letter-heading, and office space, and so on and that after three months and £1,875 which wouldn't cover all that, they might well find themselves with a spare line, spare office space, and a lot of waste paper? Forget it.

A decision was postponed till the next meeting, a month or so later (about now).

The lack of any sense of urgency should not be taken by customers as a true indication of the state of computer retailing. The problem that provoked the CRA idea originally, was unscrupulous advertising.

"Send us your money, and when we get the systems in, we will send you one, probably without half the memory chips and a vital power supply component." Nobody actually ran such an advert, but to be honest, that's how some of them should have read.

But the main problem today is maintenance. Retailers still complain of the difficulty of selling equipment in the face of cut-price competition from people round the corner who don't provide service. Yet if you ask retailers, even the most expert, most honest, most helpful ones, you will find that they don't know:

1) which machines are most likely to break down after installation . . . 2) which suppliers genuinely offer a warranty . . . 3) what is likely to go wrong with the most popular makes of micro with-

in a day of sale, or within a week of sale, or within a month of sale . . . 4) what monthly contract for a maintenance contract would be fair for the top selling makes . . . and 5) how long it takes to debug faulty hardware and get a new item out to the customer.

You can't sell washing machines like that, and if the CRA does nothing about it, the members will soon find they can't sell computers like that either.

Slip up

There is still time to enter the Computer Advertisement of the Year competition — to be judged at the opening of Computermart '80 on March 25 at West Centre Hotel. Just as well, as it gives me a chance to observe that Couchhead managing director John Godley is not John Godfrey, and he (Godley) will not be judging the ads himself. Both of these errors were perpetrated in my last Newsprint by a badly aimed editor's pen.

HP stand alone

The first purveyor of standard computers to get into the cheap computer market is Hewlett Packard. It's launched a product at the top end of the retail spectrum, at £1,950.

For the money, the customer will get what used to be called the Capricorn, when it was a secret, and what is now called the HP 85. It's a small, light and neat unit, including video screen, keyboard, tape drive, and printer; there's a 32K BASIC interpreter including graphics, and an integral UK standard power supply.

Full details will be revealed when our machine review is completed. For the moment, I am happy to leave the description of the machine as above. The only comment worth adding is that £1,950 is too much, and £1,200 would

be more like it. Within a year, that will probably be what Hewlett Packard is asking, too.

The intriguing aspect of the HP-85 is the missing partner on stage. It was expected that this New Year would see the appearance of IBM with a retail computer of similar spec but costing maybe £1,000 more.

IBM has lost its nerve. It would have to change its nature too radically if it wanted to sell a retail product, and while the writing on the wall says it will have to do so someday, executives would rather put off the evil hour.

Simply summarised, IBM sells computers the way Saville Row sells suits. It isn't the cloth, it's the fit. IBM can cut a computer system to suit a customer because it employs a very highly paid salesman to visit him often, to get to know the company, and to understand the motivations of the buyer — and work on them. IBM would add that it also produces a much more suitable system, but its detractors would deny it.

That just won't work when the product costs £3,000 or less. If it did, car salesman would try a similar approach spending a week teaching a prospective customer to drive. They don't.

IBM knows this. It can see Commodore, Texas Instruments, Hewlett Packard and Tandy selling programmable calculators across the counter, and it can see that it needs a similar retail chain carrying IBM before it can sell consumer products in high volume. Unfortunately for IBM and for all of us, the executives who ought to be putting this plan together are the men who were typical IBM salesmen ten years ago, and have been promoted. They understand salesmanship but they do not understand retailing, and they are dragging their feet.

Oddly enough for Hewlett Packard, this is not good news. The HP-85 has come into the market with a price



Arrange the standard typewriter's keys like this and it goes 40% faster — fast enough to type at dictation speeds. On this theory, the Department of Trade and Industry has bought ten word processors using the keyboard from PCD in Farnborough, at £7,000 each. If this pre-production test goes well, PCD hopes to push this "Trolley Dictation Concept" into the normal word processing market as well. Details on 0252 511001.

tag which would have looked very nice to people who were waiting for the IBM 5105 (if that was what it was going to be called). But in the absence of the IBM machine, the only similar computer — packaged in one case, with BASIC and graphics and a tape — is the PET, at a third of the price or less. All the HP offers that PET doesn't, to the first glance, is a thermal printer, and a better quality tape drive.

There's little doubt that HP-85 is better than PET. The question is whether it's three or four times better, and the answer is certainly no. That means the price will come down. When it does, of course everybody will think they are getting a bargain. That's retailing for you.

Forget superpet

Computer makers do not like you to hear of planned new, super machines because naturally they are afraid that you will postpone your purchase of the old, unsuper machines they still have on the shelves. However, anybody who postpones the buying of a PET on the grounds that Commodore is now known to be planning the Super Pet, for launch in the Autumn, will be making a mistake.

Inevitably, a new machine hits the market in ones and twos; the first may be available in September, but "yours" won't come till next April. By then, any number of other new machines will have been announced by any number of other manufacturers; you can wait for ever for the right one. At the moment, according to Printout, the superpet will have a 12 inch screen with 80 columns; it will have more internal memory (up to 64K bytes); and it will probably feature a cheap modem, to allow the machines to talk to each other down phone lines. A big disc drive with 30 million characters of store is planned too, but Printout doesn't expect this until next year.



The "best" version of Star Trek for the PET — the one that was Commodore's starrek computer kit — is now available on a £10 cassette together with Petopoly, a game of High Finance. Details from dealers.

Heath reshuffle

More astonishing than the news that Heathkit has been taken over, is its claim, at the time of the merger with Zenith, to be number four in the US micro league. Zenith Radio has taken over the Heath Company from Schlumberger — which itself recently acquired the chip maker, Fairchild. Quite why a group which had just bought into chip making should drop the number four end-user company in the same quarter, is not clear. Certainly rationalisation is planned at the Schlumberger HQ, and one of the results is that Fairchild is being asked to reconsider another operation in the UK — its joint venture with GEC, to build a factory near Liverpool.

As far as Heath goes, the change in this country will be minimal for some time; the name Heath (Gloucester) will give way to Heath Electronics (UK) and micro range items will be called Zenith Data Systems products. Details on Gloucester 29451.

PET W/P

A complete word processing system based on the Commodore PET, costing £2,900, and with software costing only £350, has been released by Dataview of Colchester. It's called Wordcraft, and uses a dual diskette. Details on 0206 78811.

NASCOM1 routines

Instant programs for the Nascom 1 kit: a book of them has been published by Sigma Technical Press.

They aren't programs in the sense of being long accounting, managerial or control suites — they are more like useful routines of the sort that a high level language often provides free, but which a man with only a thousand bytes of useable memory has trouble squeezing in. The examples



Is the PET the best seller it is, because (a) it is cheap and neat; (b) because the company which makes it understands the retail trade; (c) because Commodore marketing chief Kit Spencer is such a straightforward, genial guy, or (d) because the publicity company that promotes Commodore has that little something extra that can make a product take off? If you think the last, you will want to buy the PET systems developed by Stage One Computers for Iona Uhl (right) to handle mailing, accounting and invoicing, and activities for clients of her publicity consultancy. Turnkey prices start at £3,250 for dual disc, single printer 32K PET and software. Details from Neil Hewitt, Stage One onournemouth 295395. Then you can start your own ad agency.

are not horrifyingly sophisticated, but as an improvement on starting from scratch, it's valuable, for instance, to show how to draw a chess board, how to read a screen character for word processing, how to control interrupts... Sigma is at 23 Dippons Mill Close, Tettenhall Wood, Wolverhampton.

Ohio utilities

Utility software for the Ohio Scientific C1 and C2 range means software that does what the system software really ought to do. It renumbers BASIC statements, searches for variables in a program, and runs the program as soon as it is loaded. All this and more, at prices between £2 and £10, from Mutek in Bath, 0225 743289.

'Tis true

An add-on memory board with 16K bytes for £100 is available from Mike Dennis. It will surprise nobody to discover that I think this is the best value ever to be offered to users of the Comp Shop's UK 101 kit, or the Ohio Scientific Superboard. Mike is, after all, a consultant to PCW, and we wouldn't have anybody on the list who didn't produce superlative stuff...

Mike has also announced a relay control board for these machines. Both his add-ons sit on a 43-way bus, derived from the 40-pin expansion socket on the computers. This, to keep costs down, is a simple piece of Vero onto which fit both memory and relay control boards.

The relay is not for mains switching, the eight relays on the board controlling up to

100V at low power. "I don't approve of having mains on the same board as a micro," commented Mike. The board is latched into the memory map... that's to say it's a single byte which can be addressed as if it were a memory location, but instead of storing or recalling the data, it acts upon it.

Details from Blackberries, Sheriff & Lench, Evesham, Wores WR11 5SR.

Transam Pascal

A new version of Pascal has been picked by Transam, the inventor of the Triton 8080 kit. Instead of going for the version of Pascal offered by University of California at San Diego (UCSD) Transam has decided to offer a version closer to the International Standards Organisation working draft.

Cost will start at £80, and the main point that distinguishes it from UCSD Pascal is the fact that it will run under the CP/M operating system. UCSD Pascal is its own operating system. The language is a compile/interpret version: your statements are condensed to Peode, and that is interpreted at run time. It occupies 20K bytes of memory and it was written by Keith Frewen of TCL software (a Transam subsidiary).

At the time of going to press, the language was being tested under the Pascal Users Group validation suite, a testing system described in unpleasing terms by Derek Rowe of Abacus. The gist of his remarks was that if it fails the validation, you will know it really is rubbish, because the test will let some strange

Your Commodore PET System

The Commodore PET is Britain's best selling microcomputer and the most popular choice in every field:-

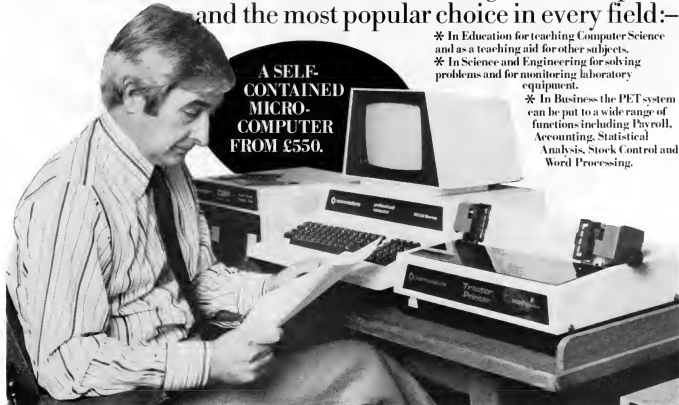

- * In Education for teaching Computer Science and as a teaching aid for other subjects.
- * In Science and Engineering for solving problems and for monitoring laboratory equipment.
- * In Business the PET system can be put to a wide range of functions including Payroll, Accounting, Statistical Analysis, Stock Control and Word Processing.

Not least of its attractions is the price of a PET - from £550 for a self contained unit, to under £2,500 for the complete system including Floppy Disk Unit and high-speed Printer. Ask your nearest Commodore dealer below for details about Commodore hardware, software and training courses.

Our Dealer* Network

LONDON

Capitel Computer Systems, W1 637 5551
ACE (by Top TV Ltd), SW1, 730 1795
Micro Computer Centre, SW14, 876 8600
Logic Box Ltd, SW1, 222 1122
Sumlock Bondain Ltd, EC1, 250 0905
De Vico Computers Ltd, NW4, 202 9630
L & J Computers, NW9, 204 7525
Adele Computers, W5, 579 5145
CAS Business Equipment Ltd, E8, 204 5252
Advanced Management, EC2, 638 9319
Keyclean Ltd, SW1, 828 2511
Microcompation, Southgate, B82 5104
T.L.C. World Trading Ltd, WC2, 839 3884

HOME COUNTIES

Orchard Electronics Ltd, OXON, 0491 35529
D. L. Chittenden Ltd, CHESHAM, 4441
J.E. Ward Computers Ltd, MILTON KEYNES, 562850
Dataflow Ltd, COLCHESTER, 76811
South East Computers Ltd, HASTINGS, 426844
Syntec Systems Ltd, SOUTHAMPTON, 38868
Alphason Ltd, BANBURY, 75606
Super vision, SOUTHAMPTON, 774023
Millhouse Facilities Ltd, ALTON, (0432) 900374
Micro Design Ltd, MIDOX, 979 4546
DDM, BRENTWOOD, 230480
Sherrill & Dorn Ltd, SOUTHEND, 82707
Alpha Business Systems, BURNING ORDE, 57423
HSV Microcomputers, BARNSTONDOE, 62444
NSV Microcomputers, SOUTHAMPTON, 22331
RUF Computers (UK), BURGESS HILL, 45211
Wego Computers Ltd, CATERHAM, 49235

T & V Johnson, CAMBERLEY, 62506
T & V Johnson, OXFORD, 721461
Patent Electronic Services Ltd, WOKING, 23637/21776
Business Electronics, SOUTHAMPTON, 738248
Amplicon Micro Systems Ltd, BRIGHTON, 562183
Bromwell Data Services Ltd, HATFIELD, 60980/64840
MMS Computer Systems, REDDIFORD, 40601
Inter-Woods, LUTON, 614202
Sumlock Bondain, NORWICH, 26259
CRE (Computers), READING, 61492
Orbafed Computer Systems, WOODSTOCK, 811976

MIDLANDS & SOUTH-EAST

Taylor Wilson Systems Ltd, KNOWLE, 6192
Bates (Systems) Ltd, NOTTINGHAM, 48108
Hobbrook Business Systems, DERBY, 360808
Lowe Electronics Limited, MATLOCK, 2817
Davidson-Richards Ltd, DERBY, 36803/4
Arden Data Processors, LEICESTER, 22255
Meadela Ltd, STONE, ON-TRENT, 613631
C.S.M. Computer Systems, BIRMINGHAM, 3606264

Business & Leisure Microcomputers, KENILWORTH, 512127
Caddis Computer Systems Ltd, HINCKLEY, 613544
Allen Computers, GRIMSBY, 40568
CFI (Data Systems) Ltd, BIRMINGHAM, 707 3866
Camdani Electronics, BIRMINGHAM, 773 8240
Chiffstock (Computer Systems) Ltd, WOLVERHAMPTON, 24221

YORKSHIRE & NTH. HUMBERSIDE

Microware Computers, HULL, 562307
Computer Workshop, LEEDS, 788466
Hellen Computer Systems Ltd, SHEFFIELD, 563325
Ackroyd Typewriters Ltd, BRADFORD, 21895
Dyson Micro Centre, SHEFFIELD, 585490
Yorkshire Electronics Service Ltd, MORLEY, 522181
Sheffield Computer Centre, SHEFFIELD, 533519

NORTH EAST

Dyson Instruments, DURHAM, 66937
Curran & Maughan, GATESHEAD, 774540
Wards Office Supplies, GATESHEAD, 605915

Tripoint Associated Systems, SUNDERLAND, 73310
Newcastle Computer Services, NEWCASTLE UPON TYNE, (0632) 615325

SOUTH WALES & WEST COUNTRY

Computer and Design, BROADSTONE, 0202 697341
A. C. Systems, EXETER, 71718
Computer Supplies (Devon), SWANSEA, 290047
Sigma Systems Ltd, CARDIFF, 21515
Dyson Computers, PLYMOUTH, 526303
Britsol Computer Centre, BRISTOL, 23430
J. A. D. Integrated Services, PLYMOUTH, 62616
Sumlock Tabouren Ltd, BRISTOL, 26685
Redan Computational Ltd, BATH, 318483
T & V Johnson Ltd, BRISTOL, 422061

NORTH WEST & NORTH WALES

B & S Computers Ltd, BOLTON, 26644
Maggain Ltd, CARNFORTH, 3801
Thornston Ltd, BURNLEY, 28461
Friede Business Machines Ltd, PRESTON, 713101
Preston Computer Centre, PRESTON, 57684
RPI, Microsystems, DOUGLAS, 4247/8

LIVERPOOL
Microdigital, LIVERPOOL, 227 2555
Rockfin Brothers Ltd, LIVERPOOL, 521 5830

MANCHESTER

Cytek (UK) Ltd, MANCHESTER, 832 7804
Executive Reprographic Ltd, MANCHESTER, 228 1837
Sumlock Manchester Ltd, DEANSGATE, (0618) 834 4233
Computer Workshop, MANCHESTER, 832 2269
Professional Computer Services Ltd, OLDHAM, 061-624 4065
D. Kipping Ltd, SALFORD, 834 6367
Cattlands Computers Ltd, 0625 527166

SCOTLAND

Microcentre, EDMURGH, 225 2022
Thistle Computers, KIRKWALL, 3140
McAlister Business Equipment, EDMURGH, 336 2402

IRELAND

Softech Ltd, DUBLIN, 784739
Medical and Scientific, LISBURN, 77533

*This is a list of dealers participating in associated advertising and is not a full list.

Commodore

We made small computers big business.

Commodore Information Centre, 360 Fuston Road, NW1 3BL. 01-388 5702

50,000TH

PROGRAM SOLD!

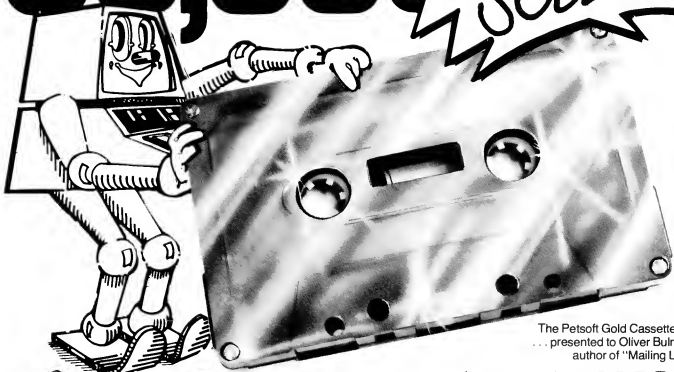

The Petsoft Gold Cassette . . .
presented to Oliver Bulmer,
author of "Mailing List"

60% OFF!

We celebrated by slashing
Ledge systems prices by over 60%:

SALES LEDGER £95

PURCHASE LEDGER £95

Developed by ACT, Britain's leading computing group, to run on a 32K PET with Anadex or Datac BD80 printers. Commodore Disk versions available price £115.

These systems provide full facilities for ledger maintenance, preparation of lists of outstanding balances, printing of statements and remittance advices. Full audit trail. Send for details.

PLUS

Disk Payroll £50 for up to 200 employees
Disk Stock Control £50 handling 2,500 stock items (Petsoft/CompuThink Disk) or 400 stock items (Commodore Disk)

AND

Mailing List £15 **VAT Pack** £17.50 **Microchess** £14
Word Processor £25 **Invoicing** £20 **Super Startrek** £8
PET BASIC Tutorial £15 **Forth** £30 **Eliza Doctor** £8
Assembler/Editor £25 **Statistics** £7 **Backgammon** 8

Prices exclude VAT. Credit card orders accepted by telephone. All programs available through your local PET dealer or direct from:

All prices correct at the time of going to Press
PET is the trademark of Commodore

ACT Petsoft

Radclyffe House, 66-68 Hagley Road, Edgbaston, Birmingham
B16 8PF. Telephone: 021-455 8585 Telex: 339396



Please
rush me your latest catalogue
of over 170 PET programs.

My name is _____

I live at _____

Postcode _____

I have a new/old ROM PET

I have NO PET

errors through. But it may be a good one for all that. Details, phone 01-2620814.

Sharp dealers

The list of Sharp MZ-80K dealers is now available. In alphabetical order, they are:

A. & G. KNIGHT
Aberdeen. 0224 630526
B.C.G. LTD.
Bristol. 0272 425338
B.C.G. LTD.
Reading. 0734 54015
B.C.G. LTD.
Torbay. 0803 557711
CENTRAL CALCULATORS
London EC1. 01-405 4113
C.R.S. (CHESTER) LTD.
Chester. 0244 317549
DATRON—MICRO-CENTRE
Sheffield. 0742 585490
EURO—CALC
London WCL. 01-405 3223
FLETCHER WORTHINGTON
Manchester. 061-928 8928
GILBERT COMPUTERS
Leicestershire. 0858 65894
H.B. COMPUTERS
Kettering. 0536 83922
KEEN COMPUTERS
Nottingham. 0602 583254
M. & H. SUPPLIES
Brighton. 0273 697231
MICRODIGITAL
Liverpool. 051-227 2535
NEWBEAR SYSTEMS
Newbury. 0635 30505
NORSETT
Cheddar. 0934 742184
PERSONAL COMPUTERS
LTD.
London EC2. 01-626 8121
PROROLE LTD.
Southend. 0702 335298
S.C.O.F.E.
London EC2. 01-247 8506
SOUTH COAST BUSINESS
MACHINES
Dorset. 0202 893040
SIGMA SYSTEMS
Cardiff. 0222 21515
SUMLOCK BONDAIN LTD.
London EC1. 01-253 2447

Paul Streecher, Sharp marketing boss on this micro, tells me he was "distressed" at my suggestion that only HB Computers had been appointed (two issues ago). The omission of everybody else was deliberate. At the time of going to press, I asked Streecher if he would be prepared to let us have the names in advance of final signing of contracts. "No," he said, "it wouldn't be fair

because some aren't tied down yet, and others may pull out. But HB Computers will have the machine at the PCW Show, so I can't stop you mentioning them."

I mention this, not to beat Paul Streecher over the head at the time of his distress, but to make a point. The point is: a month passes between my writing Newsprint, and your reading it. It's still the most up-to-date news you'll get; no use saying: "You can have the information next week," and complaining three weeks later that the information is available, and not published.

Imesai cornered

Imesai agent Corner Computing Store in Epsom has decided it can't make money selling micros, because other people cut the price and run. Graham Jenkins, Corner's boss, has been telling people he is going the way of Byte Shop, but in fact what he is really doing is moving into consultancy. This means telling potential customers what system to buy, and how to use it when they've bought it.

Jenkins has closed Corner Store, and opened Corner Consultancy instead. His partner said: "We have had so many people coming through the door who have bought machines from other suppliers. They found that they didn't understand their machines, and the other suppliers weren't prepared to spend any time helping them."

It doesn't prove anything about Imesai, but it is worth noting in passing that Corner's demise puts the number of companies who have failed to make a profit handling that franchise, to at least three . . . and that number includes the very profitable Comart distribution chain.

Stanley's success

If the retail computer business that is now developing ever wants to pay tribute to its founders, then it had



The clever thing about this £108 video display trolley from Data Efficiency is the fact that the wheels will go under an office desk, and the platform will go over it. It means the user can have it "on the desk" without lifting it up and down. It approaches 1500 other accessories in the new DE catalogue — tel 0442 57137.

better remember Colin Stanley.

Colin runs HB Computers in Kettering, and he is a founder of and driving force behind the Computer Retailers Association. Sometimes he gives the impression of being the only lucid human there.

But that achievement is not what should make him famous. His glory will be based on a little book that I only had space to mention briefly last month — called "Microcomputers and the Smaller Business". I actually think I could show this to my dentist without fear of frightening him off computers for ever.

Instead of the typical: "All computers have a central processor which consists of three units — the arithmetic unit which does the actual work of manipulating numbers, the memory which holds the program or operating instructions and certain data, and the controllers which control the transfer of information and instructions between the memory and the other parts of the computer" — all of which tells you nothing unless you knew it already, Stanley's little sales pamphlet is actually written in English. For instance:

"Data. Data is the information you KEEP at present — in ledgers, books, filing cabinets, drawers, even in your head. . . . The micro-

processor actually does the calculations, or selects addresses, (or whatever you're doing). It "borrows" information from the memory bank, "processes" it and then returns the answers to the memory bank. . . . "The main console — where most of the work goes on. You sit in front of it." I'm sure that Stanley's little booklet is capable of improvement. Somebody will do so, one day. But do most of us yet realise that the raw user *doesn't know* that you have to sit down in front of the console? He has some vague ideas of feeding a heap of cards into the air-cooling vents at the back; but he knows you'll laugh at him if he suggests it, so *he won't ask*. Keep at it, Stanley.

Sensible

A magazine on micro for education is being launched by our ex-deadly rivals, ECC Publications, which recently sold Practical Computing to IPC. It's called "Educational Computing" and will be published "in association with" IPC and edited by Pat Crabb, formerly of the newsletter (or MUSEletter) of Minicomputer Users in Secondary Education. Naturally you'll think we're sorry to see it appear; we're not. The more information there is about this new business, the better for all of us. And so far, they're not

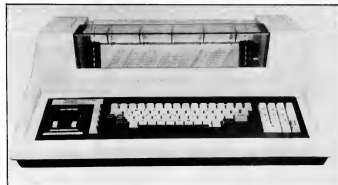

Access Data Communications will distribute the Texas Instruments model 820 dot matrix printer shown here, under purchase or lease arrangements. Details from publicity agents Span on 0296 624887.

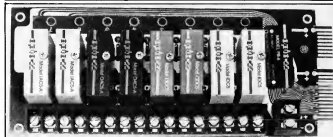

The five volt power supplies of micros need protection from the higher voltages used for industrial control: this input-output module from Rapid Recall will do that. Outputs up to 3 amps at up to 140V, inputs up to 130 V are converted to micro levels.

making the mistake of pretending that you can do without PCW as well. . . .

Communicator cuts

The "Communicator" board which Mektronic offers as a way of getting inputs into Pet and outputs out, has been drastically cut in price. From £135, the price on the single-page brochure has been amended to £79.

With the Communicator, the user can turn lamps on and off, read thermostats, ring bells, start electric motors, and so on. You'll need another board to switch mains voltages, however. Details on 061-798 0803.

Booze news

The Winemaster is a £6,000 computer . . . "the first of its kind designed specifically for wine and spirit importer and wholesaler," according to Instar Business Systems in Croydon. It allows "instant control of purchase ledger, sales ledger, nominal ledger . . . and aged debtors.

It is in fact a suite of software programs plus a North Star Horizon micro plus a terminal to run the programs on. Details on 01-680 5330.

Jeprévis

The French small computer firm Logabax is very active (in France) in educational computing. In Britain, it is very active in the orthodox "small business machine" market which it shares with firms like Philips, Olivetti, Nixdorf and the Digital Equipment value-adders.

As an illustration of how computer buyers are thinking, even in this market where the salesman is still king and retail is a seldom-remembered novelty, Logabax has published figures for "small business" computers showing that the market will grow by 22% per year until 1988, by which time the total sales will be worth £114 million. That's in the UK. In Europe, the figure will be £2,700 million — according to Logabax's estimate.

At this stage, Logabax doesn't break the figures down into sub-classes. These statistics apply to "single or multi-station disc computers costing less than £35,000". It's obvious that that very broad spectrum covers a range of machines that will never be sold over the counter. In the sub £5,000 range, where Logabax doesn't break down its figures, the company will probably see most of its growth — especially in France. Strangely, this is an area of which the UK branch seems unaware.

Enter RML Algol

A new language for Exidy Sorcerer users "and other Z80 systems with Micropolis discs" is RML Algol. It costs £99 from Liveport of St Ives, Cornwall and they describe it as an extended version of Algol 60 — the extensions being to use disc, and to handle data strings rather than mere items of input and output. Details 0736 798157.

Stock control plus

A system costing £9,950 "including training" has been launched by TDS Business Systems for the purpose of production planning; it's based on the Adds micro-system. The software is the



The company that puts the Rockwell Aim 65 flat board computer into this case has decided to branch out on the machine's behalf. Three branches are being provided; they enable the user to pretend that the Aim is a Kim, or a Motorola Exorciser, or even an S100 type computer. The advantage of this is to take advantage of any cheap, used or merely available component boards based on those three architectures. The cost ranges from £80 for the Kim expansion, to £130 for S100 or Motorola interface buses. The company is Portable Microsystems on 0280 702017.



Duncan Willis built the Amateur Computer Club's brainchild, the 77/68 microsystem, for £85. He got his printer — an ITT 3330 — from ITT for nothing, as an accolade initiated by the Electrical and Electronic Manufacturers Training & Education Board. It was a good deal for both parties: Duncan had been the star turn on the EEMTEB stand at the Electronics exhibition at Olympia last year.

heart of the system, and it will also run on Data General systems.

The crux of the software itself is that it's a very pragmatic stock control system, and beyond the mere storage of statistics. TDS says that it will not only tell the user if an order can be met by a given date, but will also spew forth information on rearranging stock if the answer is negative. That information would include a list of who supplies the parts, who is quickest on delivery, who is cheapest, and so on. Details on Blackburn 662114.

Rair addition

Software for the Rair Black Box micro. The range already offered by Sword Data Systems has been expanded

and it now includes an integrated business/ accounting system. With hardware, the system is available on rental from £45 per week. Details, Redhill 60980.

Other bits

Osborne/McGraw Hill has just published a book called "Some Common BASIC Programs". For just \$33 you get the book and an accompanying cassette containing 76 programs covering things like recipe cuttings, future value of an investment, days between two dates and all sorts of statistical routines. In these days of user friendliness, you may be astonished to find that programs expect you to key in 0 for YES and 1 for NO!

Best mixed metaphor of the month: "It seems we're barking up a gum tree". This was uttered in the heat of the recent CRA meeting. Latest news is that they are, once again, secretaryless, but all should be resolved on 23rd January.

An unshamed plug for regular contributor, Mike Knight. He will be running a residential weekend course for small businessmen called "The Mighty Micro — Is it for You?". Reasonably priced at £59 plus VAT it offers an introduction to micro-computing from first principles to implementation considerations. It will run from 23rd February in a 4 Star hotel — telephone 0303-892540 for details.

**BENCH
TEST**

THE ACT SYSTEM 800

A late arrival this month — but one that we simply can't afford to ignore — is the ACT System 800. Its importance you'll discover in a moment, but of primary interest is the fact that it offers a growth path for users of Britain's most popular personal computer, the Pet (but, no, it's not a Commodore product). David Tebbutt reports. . .

Julian Allason, the man who founded PETSOF, went to the USA charged with the task of finding a machine which could be marketed in the UK for at least seven years. There were many contenders for the prize, a substantial deal with ACT Computer Systems — in the USA there is apparently much clamouring for the British market. In the end CompuThink won with their Minimax system; they claim it to be one of the most advanced microcomputers in today's marketplace. The machine was chosen primarily for its user friendliness, graphics capabilities and minicomputer-like features.

Hardware

The system comprises an operator's console containing the computer, a keyboard and video, plus one or two floppy disc drives, depending on the system chosen. Most business systems will also have at least one printer attached.

Upon closer inspection the console is seen to have an IBM compatible keyboard plus three other keypads — one for screen control, one for numerics and one for those special characters that are usually so difficult to find. The screen control block has full cursor controls plus insert and delete, the numeric pad includes the mathematical symbols and the special pad contains characters like \$, (,), <, >, etc. It takes some getting used to, but the effort is well repaid by a high operating speed.

Like the PET, the keys can operate in upper and lower case ASCII or upper case ASCII and PET graphics. The keyboard shift can be locked just like a typewriter. It's also possible to program up to three additional character sets to suit the users' particular requirements.

The 12" screen comprises either 30 lines of 64 characters or a 512 by 240 point high resolution graphics facility. Using the "scroll" option it is possible to hold 120 lines of text in the video buffer with the screen acting as a "window" on its contents.

Field protection facilities are offered — ideal for operator prompts for example — which allow data entry only in unprotected areas. This can have a marked effect on the speed of data entry, especially when used with the

automatic skip facility which is also provided. It's even possible to split the screen such that the different parts can operate totally independently of each other. Together with some powerful editing facilities, this must be one of the most advanced intelligent videos attached to a microcomputer.

Moving on to the data storage, it gives the option of 800K Byte(5¼") or 2.4M Byte(8") disc drives. Each drive contains 4 heads operating on two double sided diskettes. It's possible to daisy chain another drive giving a maximum of 4.8M Bytes on line. Serial access of data from disc is very fast due to the fact that this system reads a whole track at a time. Subsequent accesses are then made to the disc buffer, rather than to the disc itself. Tests showed that 100 x 250 character records can be written in just over 5 seconds, including file opening and closing.

Industry standard parallel printers can be attached to the printer port without the need for additional interface boxes. And just to complete the picture, it will be possible to buy tailor made desks to house the system. CompuThink are supplying them and expect to have some in the UK in time for the launch.

Having seen the visible aspects of the machine, let's now have a look inside. The heart of the system is a 2MHz 6502 processor with 48K user RAM, suppor-

ted by 16K ROM, 26K video RAM and 16K disc RAM; between them they hold Microsoft BASIC plus graphics and disc extensions, FIFTH, a monitor, MDOS — the disc operating system, disc buffers, video buffers and up to five character sets. In addition to the dedicated disc, video, keyboard and parallel printer ports, the ACT System 800 has one serial and one parallel port. The parallel port has an associated programmable interval timer using 3 pins of the 36 pin connector. The port is driven by an INTEL 8255 programmable peripheral interface giving the options of 3 independent 8 bit parallel input or output channels with handshake capability, or one bidirectional channel with bidirectional handshaking. To the uninitiated, this means that all manner of keyboards, CRTS, D/A and A/D converters, discs machine tools and even other computers can be attached.

The serial port consists of a National Semiconductor 8250 Asynchronous Communications Element (ACE). This port is typically used for telecommunications or for driving serial printers and it can be programmed to run at anything from 50 to 56,000 baud.

Software

The ACT System 800 contains 8K Microsoft BASIC, surely by now the standard for microcomputers. In addition there are two sets of extensions —

TECHNICAL FEATURES

CPU	6502, 2MHz
Memory	106K total, 48K User RAM, 24K Video RAM, 18K ROM, 16K Disc RAM.
Keyboard	Full size, IBM compatible, numeric, function and special character blocks.
Screen	12" integral, 64x30, 240x512 graphics, up to 3 programmable character sets plus upper/lower case or upper/graphic symbols options, protected fields, split screen facility, up to 4 screens video scroll facility.
Disc Drives	Up to two dual density, dual head, twin drives. 800K, 1.6M, 2.4M or 4.8M bytes
Printers	All standard printers supported.
Ports	Serial and parallel programmable. Will drive modems, printers, discs etc.
System Software	ROM based MDOS, Monitor.
Languages	Microsoft BASIC plus disc and graphics extensions. PL/M, FIFTH, Assembler with 64 user-definable op codes.

PRICES	
808 (800K)	£3950
824 (2.4M Byte)	£4950



Top: the ACT System 800 with its 5¼" disc drive. Above left: the standard IBM keyboard flanked by the extra control pads. Above right: an example of split screen operation.

one to handle the high resolution graphics, the other to handle discs. The graphics instructions set and unset any of the 122,880 points, clear the whole screen and sense whether any point is on or off. The disc BASIC instructions are used to open and close files, read and write disc data, load and execute programs from disc.

Accessing data can be either serial (just like a cassette) or direct, according to the position of the record in the file. In the first case record lengths may vary, but in the second all records must be the same size. This enables MDOS to calculate the position of the nth record relative to the start of the file. A number of direct commands are also

available for handling the 'housekeeping' aspects of disc storage. Facilities offered are: disc formatting, essential for unused discs and handy for clearing used ones; disc directory, this displays a list of file names and free space contained on the disc; program saving and loading; program or file erasing; and, finally, a memory reset option.

All the "behind the scenes" work associated with these commands is carried out by the disc operating system — MDOS. It treats each side of each disc independently, holding the directory on track zero and leaving 39(5¼") or 76(8") tracks free for use. All files occupy a whole number of tracks which means that they must be a multiple

of 5K or 8K respectively. Not surprisingly, the 8" disc holds a maximum of 76 files per side and the 5¼" up to 39 per side, only one of which may be open at any time. This should not concern the user unduly, but it does mean a certain amount of care must be taken by the programmer. As only one file can be open at a time then the close instruction needs no parameters — thus simplifying the programmer's task. It is interesting to note that one of the manuals gives a diskette a working life of 120 hours. It therefore comes as something of a relief to learn that the disc drive motor is switched off after each operation.

Assembler programmers will be

pleased to learn that this system contains a monitor, has microprogramming facilities and runs the FIFTH language natively.

The monitor has a tiny assembler which can handle all of the 6502 opcodes plus three extras: BYT, TXT and END. BYT and TXT are used to store data — up to 15 bytes or 30 ASCII characters respectively. END is always the last statement in a program. Other features offered by the monitor are a memory dump, a disassembler and a breakpoint facility.

If the full set of 6502 opcodes is insufficient, it is possible to microprogram a further 64 instructions using the opcodes whose two low order bits are turned on, ie those whose LSBs are 3,7,B or F. The advance publicity literature suggests that a good use for this facility would be to perform Pascal. In case that is not enough, a wealth of ROM based routines are available for use by the assembler programmer.

Finally, the FIFTH language has been implemented on this machine. This language has been designed for easy transportability between systems of differing design and manufacture. In order to achieve this, FIFTH is based on the simplest common denominator between computing systems. Portable at last? — yes, but being a low level language it means that development times are likely to be quite long compared with BASIC, for example. It seems that FIFTH is worthy of an article in its own right; we shall consider this quite seriously.

Potential use

Without doubt this machine is aimed at the business/scientific/education market with the businessman having the additional benefit of several application packages available to him. Knowing the scientific and education markets' preference for developing their own systems this should not come as a shock to them.

Anyone who has invested time and money in developing PET programs will find their investment protected.

Although the transformation requires a little juggling — modifying POKE locations for example — it's minor compared with a system rewrite. ACT intend to have some new utilities which will take care of these minor irritations in due course.

ACT suggest that the system is aimed at all those people who need a mini-computer but who can't really afford one. Certainly, in many respects it competes well — the mix of high resolution graphics, characters, split screen, field protection and a comprehensive keyboard make it as good as, if not better than, many minis.

Perhaps the differences are to be found under the surface — for example at the moment it supports just one user, the disc capacity is limited and file access methods are restricted to relative direct or serial access. But then, these are comparisons with a mini which usually supports multiple use, has disc capacity in tens of Megabytes and whose access methods usually include some form of indexing. Compared with most other micros this machine must be ranked with the leaders.

Attachment of laboratory equipment should pose few problems for the scien-

tific and educational users, thanks to the programmable parallel port.

In the same way communications should be straightforward via the serial port, with its variable baud rate, data handling and modem control functions.

ACT packages available are Sales Ledger, Invoicing, Purchase Ledger, Stock Control and Word Processing. A 'Pagemate' database system is available, which enables the user to store his business information in such a form that he can interrogate the data in various ways and produce reports from the data according to his requirements. Updating facilities are included in the package as well as mathematical and statistical functions which can be applied to the data. This explanation is a gross simplification but I trust that it gives some idea. A Payroll package will be released in time for the new tax year. In addition, ACT will be offering compendia of programs on discs — games, programming aids, utilities, tutorials etc.

Finally, . . . games. Of course this machine is ideal for games, in the same way that a Lamborghini is ideal for going to the shops. That is not to say it won't happen, it's just that it's unlikely to form part of the decision to purchase.

Documentation

This is one of the best documented systems I have ever come across (in 14 years). Everything is explained clearly in the manuals that I was given —

The beginner's guide to Minimax, the Minimax Technical Manual and the Pagemate Database System. One general criticism is that all three manuals would benefit from more drawings. In particular, describing the FIFTH stack handling without pictures is rather like describing a spiral staircase without using your hands.

As well as straight facts, the manuals offer sensible advice. One example is in giving standard names to the multitude of fields which are referred to by the disc operations. Such conventions are obvious to the experienced programmer, perhaps, but the advice is ideal for the novice. The manuals also contain a very light sprinkling of wry humour: "There are a wide variety of unpredictable antics that your equipment will perform if you attempt to use a diskette that has not been formatted" being one such example.

Expandability

At the moment it's difficult to predict how the system will grow. It comes as a fairly complete package with the two programmable ports allowing a fair degree of expansion to the user's requirements. As Compu/Think are working on IMI 11M Byte hard discs, a multi-user system, FORTRAN and BASIC compilers it's not unreasonable to expect some, if not all, of these developments to appear in the UK in

due course.

ACT themselves have almost completed an integrated business package comprising order processing, stock control, invoicing, sales ledger, purchase ledger and payroll, all bound together by ACT's own database system. If you buy this package ACT will offer a maintenance agreement by which you receive all system and application enhancements as they are released.

Another possible area of development is that of ROM based software, especially after the success of the PET programmers' toolkit. This, however, is speculation and there are no firm plans for its introduction.

Conclusion

A number of business packages have already been written and, with substantial backing from ACT, — plus 9 regional distributors and dealers throughout the country, all carefully chosen for their experience and engineering support — I cannot see how this system can fail. It's a well made, easy to use product and it gives the PET user a (relatively) easy growth path. It's bound to sell extremely well with the limit likely to be dictated by Compu/Think's production capacity rather than by level of demand.

At a glance

FIRST IMPRESSIONS	
Looks	***
Setting up	****
Ease of use	****
HIGH LEVEL LANGUAGES	
BASIC	****
COBOL	n/a
FORTRAN	n/a
Pascal	n/a
System Software	***
PL/M	available
PACKAGES	
Business	****
Education	n/a
Home	n/a
PERFORMANCE	
Processor	****
Cassette	n/a
Disc	****
Peripherals	n/a
EXPANSIBILITY	
Memory	n/a
Cassettes	n/a
Discs	***
Buses	***
Ports	****
COMPATIBILITY	
Hardware	***
Software	***
DOCUMENTATION	
VALUE FOR MONEY	****
****	excellent
****	very good
***	good
**	fair
*	poor

Benchmark Timings (in seconds)

	BM1	BM2	BM3	BM4	BM5	BM6	BM7	BM8
ACT 800	0.9	4.6	8.5	9.4	10.1	14.9	23.4	5.6
Micromation	1.4	4.4	11.2	11.3	11.5	21.2	34.9	3.9
Z-Plus	0.9	3.4	11.2	10.5	11.2	18.0	28.9	3.7
Cromemco	1.7	4.6	14.9	17.8	19.4	30.2	41.9	22.9
System 3	1.9	5.7	16.4	19.7	21.3	32.4	44.1	22.9
PET	1.7	9.9	18.4	20.4	21.0	32.5	50.9	12.3

PCW welcomes correspondence from its readers. Be as brief and concise as possible and please add "not for publication" if your comments/questions are to be kept private.
Address letters to: "Communications", Personal Computer World, 14 Rathbone Place, London W1P 1DE.

Homebrew notes

Martin Lea's design for a Z80 homebrew has done for the Z80 what the 77-68 did for the 6800. It may not be the first Z80 system of its type, but it is the first I have seen in print.

While not wishing to detract from his design, I feel a few comments may be of interest to Martin and other prospective constructors. These mostly concern expansion of the present design.

1. "All that is needed to interface 16K of dynamic memory is an address multiplexer" is a considerable oversimplification. Although I would agree that the Z80 does make interfacing of dynamic memory much simpler than say the 6800 or the 8080 it still requires at least 5 LSTTL devices and 3 STTL devices, and could not be used at 4MHz with the current design without WAIT states. See the Zilog Application Note "Interfacing 16 pin Dynamic RAMs to the Z80A Microprocessor" for more information.

2. The reset circuit shown (N22, N23) is adequate if only static RAMs are to be used, but must not be used with Dynamic RAMs if data is to be retained after reset. This is because if "RESET" goes low during T3 of an Op-code fetch (M1) cycle then MREQ goes indeterminate about 10 clock cycles later, possibly causing a short or aborted RAM access and destroying data in the RAM (see P.59 of the Mostek MK3880 [Z80] Manual).

3. The minimum memory access time is during an Op-code fetch cycle and is 445ns (not 560ns as stated in the article) at 2.5MHz and 255ns at 4MHz (Zilog App. Note). Allowing worst case figures for IC7, IC12, IC6 and IC8 (18, 18, 10 and 25ns respectively) then data could be available a maximum of 321ns (for 250ns memory) or 521ns (for 450ns memory) after MREQ goes low. While typical times for these devices show that they probably will work, "Sod's Law" says that they won't without WAIT states (250ns will be OK at 2.5MHz). WAIT states rather defeat the object of a faster processor and should be avoided if possible. 4. Finally, if it is intended to use the vectored priority

interrupt system then the data bus buffer IC7 must have its R/W line pulled low by both M1 and RD since RD is not active during the interrupt acknowledge cycle when the CPU fetches the interrupt vector. This is simply done by "OR-ing" M1 and RD since all M1 cycles are RD cycles anyway (see P.61/62 of the Mostek Manual).

Anyway, congratulations to Martin for having the guts to publish his design. Keep up the good work in 1980, PCW. I.Caplan, Southgate

Martin Lea replies: Thank you for your comments, especially point 4 which has revealed an oversight in my circuit. However, your solution of combining M1 and RD will require an additional AND gate in the circuit which will either have to be one of the buffer gates or will require an extra IC. A nearer solution is to reverse IC7 so that B0 to B7 are now connected to the MPU. The direction of IC7 (R/W pin 1) is now controlled by WR. During an interrupt acknowledge cycle WR is inactive so the buffer is in the read mode, allowing the interrupt vector on to the MPU data bus.

Cassette cure 1

As any PET user knows the most annoying part of loading from Cassette is waiting for the FOUND..... message.

This is mainly due to the lack of a tape counter, but even with a counter you would not know if the PET had passed the Program Header. You can sometimes miss the header - wait several minutes - only to find you are on blank tape. My method is as follows:
Connect a Soundbox to the user Port Pin 6 (cassette No. 1 Read). The Soundbox connection is Pin M (CB2 Line).

On both SAVE and LOAD you can then hear the following:

- The Header Tone
- The Header Token
- The Header 'Title'
- The Program DATA
- The 'Half Way Point'
- Second copy of DATA
- The end of file Token

By using the F.F.WD, PLAY and REW keys you can then locate the header on a multi-program tape - Press Play - and wait. If you

do not get the message FOUND..... at the Header Title stage, rewind slightly and try again. Using this method you can CUE the tape to the right position.

Other advantages are that you can also hear:

- DROPOUTS
 - CROSSTALK
 - NOISE
 - VARIATION in PITCH due to tight Cassettes.
 - The difference between DATA and PROGRAM tapes.
- This is an invaluable aid, and is best implemented by fitting a small toggle switch to the cover of the user port connector. i.e.
- Position 1 SOUND (Pin M)
Position 2 OFF (No Connection)
Position 3 CASSETTE (Pin 6)

With Pin N being the 'earth'.

For those who like to keep a 'Working Copy' of their programs in addition to the 'MASTER' a separate cassette is an advantage.

I use an Hitachi TRQ 299 which has an automatic level control (ALC) and a Cue and Review facility. In my case the ALC gives perfect results on the PET recordings every time. The Cue and Review facility allows you to fast wind using Cue to find the 'nth' program on the tape.

Position the header using Review and transfer the tape to your PET cassette.

Perhaps somebody will devise a method to convert the PET cassette to 'Cue the Review'.

Incidentally can anybody suggest a method of recovering data from a Program tape, on which the header and part of the first copy of DATA has been erased? (Caused by pushing RECORD instead of PLAY).

R. Cason, Sawbridgeworth, Herts

Cassette cure 2

Re Pet Protection in Computer Answers, PCW Dec. '79.

While endorsing everything said by Jon Malone, I find that I can get extra protection by numbering records as they are written on to tape. On subsequent input, read errors are detected by testing the status word. If there is an error, a routine allows the tape to be re-wound a little and read again using the record numbers to go back to correct place in

the file. I find that a second attempt to read a faulty block often succeeds - whether it involves a data file or a program file. Even so I do keep duplicate copies! D.S. Skene, Maidstone, Kent.

Revas rollicking 2

The Editor's reply to Mr. Lawson's justified complaint on the delay in printing the Revas program will surely leave readers to draw the following conclusions -

1. PCW are reluctant to publish programs that exceed a few pages of type and any such program listing may or may not be concluded.

2. PCW are under the impression that all Z80 based computers support tape input and have standard formats! i.e. the Editor's comment that the Revas program is "available on tape for a trifling sum". A quick survey of the 'In Store' pages reveals 35 different computers that use the Z80 yet the tape program referred to is only available for the Nascom. The whole point of printing a program listing is to make it transportable and therefore of use to the maximum number of readers.

Perhaps the Editor would reassure at least one of its currently "loyal readers" that the implications of his reply to Mr. Lawson will not be reflected in the magazine's future policy. D.J. Bullock, Solihull, West Midlands

Good point, we give in. The readers are always right. You can look forward to assembler and machine code programs in future issues - Ed.

Mind your language

I should like to take the opportunity to draw to your editorial attention that someone in your publication seems to have taken a liking to capitalizing the name of the programming language Pascal. I don't know what he or she thinks P.A.S.C.A.L. or PASCAL might stand for, nor do I have much sympathy with the implicit lack of knowledge. However, it is an easy thing to put right, if you will alert your sub-editors.

On page 47 of the December issue you reprinted a set

of eight Basic Benchmarks with a Bench Test of *The Micromation Z-Plus*. In case anyone wishes to run the tests and compare them with a Pascal performance, I have translated the tests in Pascal. I also have a table showing the performance of Berkeley Pascal running under Unix on a PDP-11/34 (anyone interested in a copy, send SAE to PCW — Ed).

The combination of interpretive system, little optimization, and slow processor yields results very similar to those with Basic, which is not surprising. Pascal's motto has never been "do it anyhow, as long as it is fast", but "do it right".

I will however comment in passing that I know some Pascal compilers that generate code for microprocessors that would realize that much of the code in these Benchmarks does nothing, and would delete it. One compiler, I suspect, would reduce them all to two print statements. Comparative results will then be fascinating! Arthur Sale, Professor of Information Science, University of Tasmania (on leave at Southampton)

Thanks for the Benchtests. The person in our organisation with the "implicit lack of knowledge" points out (most humbly) that he is obviously in good company, as you yourself have referred to Basic — as opposed to BASIC (standing for Beginner's All-purpose Symbolic Instruction Code). With respect to your observation regarding the code in the Benchmarks doing nothing, the same person asks the question: "Is putting a deliberate delay in a program really doing nothing?" Last time we saw him he was walking into the sunset muttering: "CoBOL, FOR A = 1 TO 10: NEXT A, ForTran, FOR B = 1 TO 10: NEXT B, AlgOL, ..." — Ed.

Texas tout

I own a Texas Instruments Programmable 57 calculator, and find the normal instruction manual very useful. However, I do not have much experience of writing programs nor much time to practice the art. I thus wrote to TI at Bedford hoping that they would be able to supply additional programs for this machine. They have replied to the effect that they do not run programs for the 57 other than those shown in the manual, but they did suggest that your magazine might be

able to assist in this matter. I would be grateful for any advice you could give. J. E. Wynn, Peterborough, Cambs.

Apart from recommending that you read PCW regularly, we appeal to any readers who think they can help to contact J. E. Wynn at 22 Ashridge Walk, Yaxley, Peterborough, Cambs — Ed.

Try this

Readers with the bigger PETS (16K or 32K) might like to try this:

```
5 DATA 1,13,1,26,9,14,7,33,33
10 FOR I = 1 TO 100
20 X = 6502
30 WAIT X,Y
40 NEXT Y
50 PRINT CHR$(147)
55 FOR I = 33220 TO 33228
56 READ Z:POKE I,Z
60 NEXT I
```

Peter Verstage, London WC1

How about VAT

I've been playing with a word processor package, hence this extraordinary product! (The letter is "long and thin") However, don't worry — I've got a Heathkit Printer on order and I've been promised the indefinite loan of a Daisywheel Printer too, so you or any other of my correspondents won't suffer long. (Well — I might as well put my hard-earned expertise to some purpose!)

I was interested to read J. S. Linfoot's letter in reply to my bit about V.A.T. ("Interrupt" October 1979) You were right — it is an odd letter. He seems to be objecting to the word "luxury". However, you hoped that that column would "stir 'em up a bit", didn't you?

You might want to publish a comment from me, so here goes:

"You've caught me with my pants down, Mr. Linfoot. What can I say? I'm sorry — you are right and I was wrong. "So, we now have a standard rate of 15% VAT instead of a luxury rate of 15%? I suppose that's OK then — let's all forget it. I suppose that it doesn't matter what we pay as long as it isn't called a luxury". D.R. Daines, Sutton-in-Ashfield, Notts.

MK14 message 1

In a way of reply to the letter sent by Mr. Clarke (PCW Dec), concerning the

problem of displaying messages on the MK14, I enclose a program that demonstrates the way which a word can be shown for short periods of time.

A delay must be set after each character is written out so giving a steady line — a delay after all 8 characters would leave the last character slightly brighter than the others.

After the line has been shown once, instead of just doing the whole operation again, we reduce a counter by

Program To Display Hard Luck on Mk14 Display

Location	Instruction	Hex code	Comments
0F12	LDI 0F	C4 0F	Set up P2 to 0F --
0F14	XPAH (2)	36 00	Load 00
0F15	XPAL (1)	31 00	31
0F18	LDI 0D	C4 0D	Set P1 to 0D00
0F1A	XPAH (1)	35 00	35
0F1B	LDI 80	C4 80	Start off at 0F80
0F1D Next	XPAL (2)	32 00	32
0F1E	XRI 80	E4 80	P2 low is 80?
0F20	JNZ PUT-80	9C 04	Not so to put-80
0F22	LDI 90	C4 90	Load 90
0F24	JMP SET-P2-LOW	90 02	Skip a load.
0F26 PUT-80	LDI 80	C4 80	Load 80
0F28 SET-P2-LOW	XPAL (2)	32 00	Put in P2 low
0F29 DISP	LDI 08	C4 08	Loop 8 times
0F2B	ST counter	C8 D4	Count at 0F00
0F2D loop	XAE	01 00	Leave in ext.
0F2E	LD (2) (E)	C2 80	Load message byte
0F30	ST (1) (E)	C8 00	Store on display
0F32	LDY 01	8F 01	Small delay
0F34	DLD counter	B8 BC	Reduce count
0F36	JNZ loop	9C F5	If not 8 times
0F38	DLD 256-count	B8 C8	Back to loop.
0F3A	JNZ DISP	9C ED	Do 256 times.
0F3C	JMP NEXT	90 FD	Endless loop back to Next.

WORKING STORAGE: 0F01 counter
0F02 256-count

START ADDRESS: 0F12
(E) indicates that current value of extension register to be used.

Messages:
enter: 0F80 00 00 5E 50 77 74 00 00 'hard'
0F90 00 00 75 58 1C 38 00 00 'luck'

MK14 message 2

In the December issue of PCW Mr David Clarke asks for suggestions for displaying a sequence of words on the MK. 14.

This letter is intended to give some hints. I wrote a program which displayed three words in succession, left the display blank for a short period, and repeated the routine indefinitely. Before the program is executed, it is necessary to store the segment patterns for the letters of the different words at certain addresses.

It seems easier to explain the program if we take an example. Suppose the message is "HAPPY BIRTHDAY HAROLD". There are only 8 positions in the display. We assume that there are not

1 and test for 00. So we loop round 256 times only — long enough for the message to be noticed, in fact from 1 to 10 seconds depending on the delay value at 0F33. The program displays the message stored backwards at 0F80-7 and then changes it for the message at 0F90-7. This process repeats endlessly.

G. Phillips, London NW9
Thanks for the SC/MP programming pencil! — Ed.

more than 8 letters in any of the words (if there are less, the segment pattern for the blank positions is "00"). For the first word, we have the arrangement at the foot of this column.

To achieve the display, we shall want to send the segment pattern of 0F12 to address 0D07; of 0F13, to 0D06, etc. The initial letter of the second word will have its segment pattern stored at 0F1A; of the third word, at 0F22.

It may not be essential, but it is convenient, to have a sub-routine for displaying each word. The main program will then have the task of deciding whether it is necessary to have a pause (after the third word). If it is not, it will have to change the address (in the sub-routine)

Continued on Page 100

Address	0F12	0F13	0F14	0F15	0F16	0F17	0F18	0F19
Segment Pattern for	H	A	P	P	Y	(00)	(00)	(00)

ACT800 DEALER GUIDE

ACT COMPUTER SYSTEMS



ACT SYSTEM 800

TVJ

CAMBERLEY (0276) 62506 OXFORD (0865) 721461
BRISTOL (0272) 422061

**MICROCOMPUTERS
ETC**

T & V JOHNSON (MICROCOMPUTERS ETC) LTD.
Member of the TV Johnson Group of Companies
165 London Road, Camberley, Surrey GU15 3JS
48 Gloucester Road, Bristol BS7 8BH
148 Cowley Road, Oxford OX4 1JJ

Branches at: Birmingham, Bristol, Edinburgh, Leeds, London, Louth,
Newmarket, Nottingham, Oxford, Byfleet, Wokingham.

ACT COMPUTER SYSTEMS

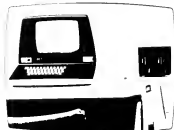

ACT SYSTEM 800

**HB
COMPUTERS**
22 NEWLAND STREET,
KETTERING, NORTHANTS.
Tel. (0536) 83922 &
520910 Telex 341297

ACT COMPUTER SYSTEMS



ACT SYSTEM 800



LION MICRO-COMPUTERS

SMALL COMPUTERS - TO MAKE YOUR BUSINESS BIGGER

Lion Computer Shops Ltd, Lion House, 227 Tottenham Court Road,
London W1 (First Floor) Telephone: 01-637 1601

Telex 28394 Lion G.

Open 9 to 6, Monday to Saturday (Thursday to 7)



ACT COMPUTER SYSTEMS



ACT SYSTEM 800

BUSINESS ELECTRONICS
ROWNHAMS HOUSE, ROWNHAMS,
SOUTHAMPTON
Telephone 0703 734015

ACT800 DEALER GUIDE

ACT COMPUTER SYSTEMS

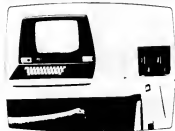

ACT SYSTEM 800

SOUTH EAST COMPUTERS LTD
4 Castle Street

Hastings, Sussex

Telephone: 0424 440099

OPENING IN MAIDSTONE ON FEB 1st 1980

ACT COMPUTER SYSTEMS



ACT SYSTEM 800

Robox Office Equipment Ltd

Unit 14, Anderson Shopping Centre,

Argyll Street,

Glasgow G2 7PH

Telephone: 041-221 5401

ACT COMPUTER SYSTEMS

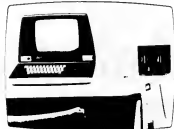

ACT SYSTEM 800

1 2 3 4 5 6 7 8 9

TAYLOR WILSON

TAYLOR WILSON SYSTEMS LTD
OAKFIELD HOUSE, STATION ROAD,
DORRIDGE, SOLIHULL, W. MIDLANDS B93 8HQ
Tel: Knowle (056 45) 6192 (8 lines) Telex: 336513

ACT COMPUTER SYSTEMS



ACT SYSTEM 800

Jeff Orr & Graham Knott are
now offering . . .

PHONE US ON

051-

Stack Computer Services Ltd
1 Westward View, Waterloo,
Liverpool L22 6RB

924 1125

for details of our catalogue or write



ACT800 DEALER GUIDE

ACT COMPUTER
SYSTEMS



ACT SYSTEM 800

PETALECT

ELECTRONIC
SERVICING LTD.

PETALECT ELECTRONIC SERVICES LTD

33/35 Portugal Road,
Woking,
Surrey.

Tel. Woking 69032/68497

Shop at:

PETALECT
Chertsey Road,
Woking,
Surrey.

Tel. Woking 21776 23637

ACT COMPUTER
SYSTEMS

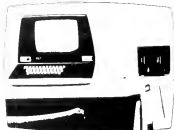

ACT SYSTEM 800

**dale
dams**
OFFICE EQUIPMENT LTD.,
30-36, Dale Street,
Liverpool

IAN KENDRICK

051-227-3301

ACT COMPUTER
SYSTEMS

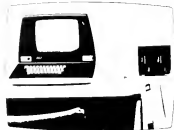

ACT SYSTEM 800

JOHN PERCIVAL

MMS COMPUTER SYSTEMS

26 Mill Street,
Bedford, Beds.
0234 40601

ACT COMPUTER
SYSTEMS



ACT SYSTEM 800

FOR FULL DETAILS & THE
NAME OF YOUR NEAREST DEALER:

ACT MICROCOMPUTER
SYSTEMS

66-68 HAGLEY ROAD
EGBASTON
BIRMINGHAM B16 8PF
021-455 8686



Steve Shirley, Vice-President (professional) of the British Computer Society (BCS) and Chairman of the F International Group, talked to PCW recently about the Society and its increasing relevance to PCW readers. David Tebbutt reports:

FANFARE FOR THE BCS

From its inauguration some 21 years ago, the BCS is now probably the longest running computing club in the UK. With some 25,000 members drawn from all walks of computer life, it offers a forum for discussion and exchange of information between people interested and involved in the various aspects of computing. Mirroring the rapidly growing interest in personal computing, there are already a number of sub-groups devoted solely to micros.

Branches cover the UK in geographical areas; they are intersected by specialist groups, clustered around specific areas of interest and only occasionally split on a regional basis. For example, a very large number of people are interested in medical computing and a relevant specialist section runs sub-groups, meetings and activities all over the country. To a lesser extent, the Committee for the Disabled (originally based in the Home Counties) now has a centre of activity in Manchester, and further centres in Bristol and elsewhere are well past the planning stage.

A specialist group, dealing with personal computing, only requires half-a-dozen affiliate members to be able to set up within the proven guidelines laid down by the Society. It is not the (small) budget available to assist such groups that is important, but the secretarial and support services, the medium for social and technical interchange and the Society's status in the world outside. Says Steve

Shirley: "The BCS lays out the welcome mat for everyone involved in personal computing. We feel that the Society has much to offer and can itself only benefit from the involvement of microcomputer buffs".

And apart from affiliate membership, some PCW readers will be technically eligible for the professional member grade — one that is of real, and monetary, value to employers. It's even possible that a few of those amongst us could become Fellows of the Society. Each year about twelve Fellows are appointed by the BCS for their special contribution to the history of computing. But, most important perhaps, the Society welcomes personal computing enthusiasts as affiliates.

Extra benefits include a library which, among other things, is a goldmine for proven algorithms, and a journal — a rather intimidating document, appropriate to a learned society. There's also a whole range of events and functions; for example a computer fair next Summer (run in conjunction with the DOI) and a seminar in March dedicated to high level languages for micros. And for those who are interested, there's a series of examinations by which one can obtain professional qualifications.

PCW readers and the BCS have several areas of mutual interest, two in particular being compatibility and communications. On the former, one time President of the Society, Alex d'Agapeyeff, said at the Thames

Polytechnic earlier this year: "People don't want personal computers to be entirely different microboxes. We want a situation where, if yours won't work, you go to the office next door, or the house next door, and you borrow theirs. You are only going to do that if they are the same."

The solution to this problem was invented by one Alan Shearing, well before the era of the hobbyist or even mainframe computing. In the computer pioneering days, he defined the need for a language which could be executed by the machine in the same way, regardless of the equipment used. That idea, originally English, has now been developed in this country by CAP. It is of course their Microcobol.

On communications Steve says: "I should not like to predict the precise impact of personal computing on business from a security point of view. As home computers become more widespread, and it gets easier and easier to attach them to telephone lines, they'll carry potential benefits to users as well as potential threats to large networks containing sensitive information."

"Several known perpetrators of fraud have used home computers to simulate either false input or output, to program routines that determine unknown passwords, or to break into a network and sign on as a legitimate user. Is it therefore any wonder that the BCS is laying down the welcome mat?"

"To be more positive, personal computing may well bring desk-top inter-

rogation facilities to the auditor's office, remote from the installation, but able to make dynamic enquiries as a legitimate terminal in a totally authorised fashion. The BCS is much involved in developing 'dynamic auditing' techniques, using non-intelligent terminals."

Various distinguished members of the BCS are active in fields which the layman would consider almost synonymous with personal computing. Jack Cluley, Chairman of the membership board, is himself very involved with micros — mainly their use in industrial applications. Steve Shirley again: "Everyone concerned with education and training — and who can afford not to be nowadays — is committed to making the education system cope with the new technologies. For all aspects of life, working or not, are being pervaded by micros."

"The new hardware is often home-programmer driven and cuts across all previous curricula. The BCS recognises personal computing enthusiasts and hobbyists as a very important grass roots movement that's pushing for more knowledge and more information. And it is ready and willing to provide the forum".

If you would like to join the BCS, apply, preferably in writing, for affiliate membership to: *The British Computer Society, 13 Mansfield Street, London W1M 0BP, Telephone 01-637 0471.*



HEATH WH-89

For many of us who cut our first multi-core cable on kit products, the name "Heath" still conjures up memories of smoking soldering irons and potting shed electronics — even though at the time one encountered the feeling that somehow their products were a little old fashioned and expensive. Anxious now to lose some of that "kit" image, Heath recently answered the challenge of the chip with a microcomputer designated the WH-89 (H-89 in kit form). Robust and solid looking, the machine divides handily into a CPU/intelligent terminal combination; its intended destination is undoubtedly the increasingly lucrative business market. Carrying out his first Benchtest for PCW, Mike Dennis reports on the relative success of the transition.

Have Heath kept up with current technology... and what's more have they found the right price?

Hardware

The Heath WH-89 (shortly to appear under the new logo of Zenith Computer Products) is an all-in-one computer with integral 5¼" Wang floppy disc. It's quite heavy (50lbs) but not too awkward for one person to carry and it's fairly deep (20") and so would, ideally, need a larger than normal desk for comfortable operation. The housing is a two tone grey cabinet with optional green sheet of perspex that flops over the screen. Access to the insides is via a hinged, removable top cover and mounted to this is a cooling fan which, on the review sample, was excessively noisy — Heath say that this is not normal.

The majority of the electronics are carried on two large vertical boards at the rear of the case and any additional PCBs (eg floppy disc controller) plug into the front board. There is space for 6 extra PCBs but since one is already tied up with floppy controller and another for printer interfacing, this leaves four. The VDU screen gives quite a pleasant display although the review sample suffered from a small ripple that "wiggled" through the display and was mildly disturbing.

The general standard of construction was rather mediocre giving an impression of hurried assembly. There is a veritable birds-nest of wires down the RH side, boards and bits sprout everywhere and one capacitor case was perilously close to shorting out the main bridge rectifier — the sticky bit of foam rubber to prevent this event happening had slipped. I would hate to have to repair one.

Heath have only two service centres (London and Gloucester) but can arrange for a servicing contract with Computer Field Maintenance.

System layout

The VDU section is intelligent and has its own Z80, 6845 CRT controller, 3K of RAM and 1K of ROM. There are nine additional function keys and these generate ESC followed by another letter. It is then up to the user's program to detect the appropriate codes and act upon them. In fact, extensive use is made of the ESC key and others to provide a VDU with remarkable

flexibility — on screen editing, graphics, direct cursor-addressing etc. These capabilities can, of course, just as easily be used by the computer outputting the appropriate codes.

There is also a separate numeric keypad, but unfortunately I was unable to exit from its alternative set of key values; whether this was due to a genuine fault or the exit routine supplied by the manual, I don't know. Anyway, suffice it to say that with its 80x24 character format (and optional 25th line for system messages etc.), the VDU section is remarkably comprehensive. As the interface to the computer is via an RS-232 circuit, it does mean that you can also hook the WH-89 up to any other computer, as an intelligent terminal.

The computer board again uses the Z80 with 48K of dynamic RAM, 1K of static RAM for the floppy disc and 4K of firmware in ROM. On switch on, you either boot down HDOS or operate at machine code level. Machine code programming is further supported with the inclusion of two disc based utility programs — DBUG and an assembler. DBUG provides general debugging routines (including the ability to set a breakpoint in a loop, execute that loop for n-1 times and then break). Apart from that, DBUG is not particularly

memorable.

The assembler also is a bit of an apology for it only accepts 8080 mnemonics and instructions. True, you can bodge it and make it accept the extra Z80 codes but you are still stuck with 8080 mnemonics plus all the hassle of the bodes. What's worse is that the assembler, in common with all the machine code routines, is done using OCTAL!!

To my mind, that decision is indefensible; why Heath stuck to Octal is beyond my comprehension, especially as the CPU is a Z80. If you want to do any machine code development using the Z80 then look elsewhere.

System software

System software comes with HDOS and Extended Benton Harbor (where Heath come from) BASIC (abbreviated to EBHB). HDOS has close affinity to DEC's RSX-11 operating system. . . you can FIP, SYSGEN, mount and dismount discs and set wild cards to your heart's content. The BOOT is a little untidy — you type B (whereupon the computer types "oot! for you!), type some spaces then enter the date (no silly dates allowed — apart from April31st!) and then you are in HDOS. The whole routine takes about 25 secs

Technical Data

Computer

CPU: Z80 — 2MHz
Memory: 48K dynamic RAM
Cassette: Not tested
Disc drives: One 5¼" WANG
Printer: Not tested
Bus: Heath's own
Ports: via serial I/O cards
System software: HDOS
DBUG

ASM — 8080 only
Extended Benton Harbor BASIC
Microsoft BASIC (MBASIC)

Languages:

VDU

CPU: Z-80
Memory: 3K static RAM
Keyboard: Standard QWERTY
Nine function keys
Separate numeric pad.

Port:

VDU: Reverse video
80x24
Optional 25th line
Graphics

DYNABYTE, The Business Computer System Your Customers Can Afford.

For less cost than a new company car, your prospects can own an expandable computer system that will fully automate their business. And you can teach their bookkeeper to run the system with just a few hours of training, on-site, in a single day.

Field Tested Programs: Over 600 Dynabyte systems are in use across America generating timely reports, P & L Statements, Payroll, Accounts Payable, Accounts Receivable, Inventory Control, Data Base Management, Word Processing and customized programs. Dynabyte supplies high level languages for specialized needs including BASIC, FORTRAN, COBOL and PASCAL.

Expandable Diskette Memory: Your customers can select from 5¼" or IBM compatible 8" floppies with compact single station memory storage from 650,000 words up to 2 million words;

or multiple terminal systems with 10 million word storage capacity. Users can start small and then add more memory and multi-tasking functions as needed by their growing business.

Price, Performance, Service: Dynabyte offers the business computer system at prices customers can afford, with proven reliability and modular construction allowing overnight service in most areas. For more facts, contact Dynabyte Sales at (415) 329-8021.

DYNABYTE

UK EUROPE INTERNATIONAL LTD.
28 PARK ROAD, FALSGRAVE, SCARBOROUGH,
N. YORKS YO12 4AH
Telephone 0723-65559 73338 Telex 52317



All Systems Are Not Created Equal

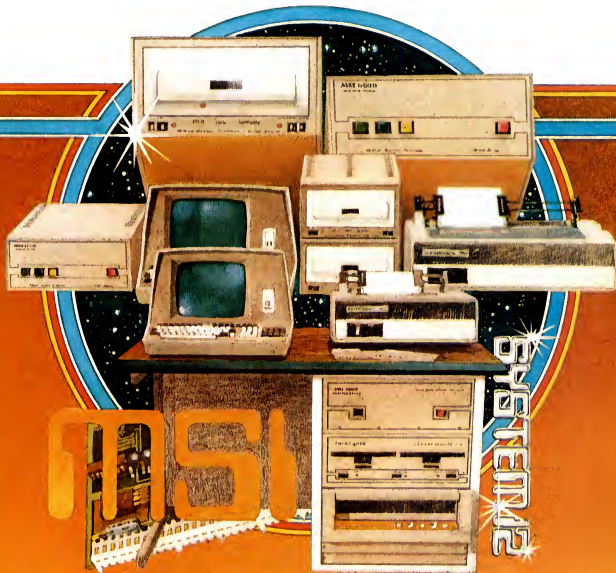

Your computer application is unique. It differs from all others. It is because not all applications are equal that MSI has developed a variety of computer systems.

At the heart of every MSI System is the powerful MSI 6800 Computer, one of the fastest and most versatile available. Depending on the System you select, the MSI 6800 has from 16K to 56K of RAM. Mass memory storage in MSI Systems range from 315K bytes in the System 1 to over 10 megabytes in our most powerful System 12.

In addition to the computer and memory subsystem, MSI Systems include a CRT terminal and high speed character printer. The System 12 is housed in a compact desk unit.

As with hardware, computer software is not always created equal. Since there are a myriad of programs available, MSI offers a choice of Operating Systems for use with your MSI Computer System. Of course, our favourite is MSIDOS, but we offer the powerful SDOS operating system as well. All MSI Systems will support the other software products associated with each operating system.

MSI also has a variety of software programs including a Multi-User Basic program capable of supporting up to four users.

MSI Systems are currently being used in a broad spectrum of personal, scientific, educational, professional, and business situations. In addition to our Systems, we

can supply you with individual components for personal and OEM use. All MSI System components are available, some in kit form.

Write or call us for more information about MSI Systems and products and the name of your nearest MSI dealer.

seed

Strumeh Engineering
Electronic Developments
Portland House,
Coppice Side, Brownhills,
BRO 4321 Telex: 335243



but you have to be there in attendance and as I was booting into and out of the system quite frequently (of that more later), it all became a trifle tedious. There would appear to be no turnkey facility.

Once into HDOS, you can INITIALISE, SYSGEN a disc, make a back-up copy and run a very comprehensive diagnostic TEST routine. This includes a head seek test (typically 30ms but the review sample actually achieved 8ms which is good). Since you can SET various parameters, including the seek time, this does provide the user with the opportunity of "fine-tuning" the system to achieve optimum performance. You can set flags for each file, the most notable being LOCK. However there is no UNLOCK command! The only way to unlock a file is to INITIALISE the entire disc but since this will erase all your other files, it does seem a bit drastic. You can also run a sector check, note down the bad sectors and feed the information in at the appropriate time during INIT. The disc being INIT'd will make a note not to use them in the future, which makes for a nice feature. You can also ask HDOS for a status report whereupon the number of soft and hard errors and reads and writes made to date are printed to the screen - quite a useful facility. The documentation for this stage does include a first time users path to follow but it's not really obvious what the overall aim of the various stages are; for example, does one always have to SYSGEN every disc? It's not made very clear by the instructions although the 'first time user read here' concept is very good.

The only slight quibble was that sometimes backspace did backspace and delete, sometimes it did not (this is one of the many alternative modes of VDU operation that the WH-89 will accept). In fact, in general, I wasn't entirely confident that pressing some keys would produce the same response as the last time if the system had been rebooted or MBASIC entered. One had a feeling that there were one or two little quirks, although this could be partly due to unfamiliarity on my part. So all in all, a very flexible VDU keyboard and DOS.

DISC ACCESS TIMES (in seconds)

Disc Test 2	20.5
Disc Test 3	19.0
Disc Test 4	22.0
Disc Test 5	18.5

Basic

I ran the benchmarks for EBHB and as you can see, they're very, very slow. No information is given as to whether or not you can access the disc using EBHB - I assume not, I didn't think much of EBHB and so looked forward to trying Microsoft BASIC (MBASIC) which was supplied on another disc.

The first disc I tried evoked the error message from HDOS telling me that the disc needed to be SYSGENed first. As it was a so-called distribution disc it does seem a bit daft that it wasn't already done. As it was my only copy, I was rather reluctant to try my hand at SYSGENing for the first time. Nor could I copy the disc as all my Verbatim and "white box" discs yielded a "WRONG MEDIA" error message when I tried to INIT them. Apparently, only

Memorex discs seem to work satisfactorily which is great for Memorex but not for the user.

Fortunately, a man from Heath came by bearing another copy and this worked fine - or so I thought. The unfortunate fact was that although both the main system disc and the MBASIC disc purported to have the same issue and version of HDOS, the two were not compatible. Booting up with one disc and trying to use the other always caused the system to "FATAL SYSTEM ERROR", necessitating a complete reboot of HDOS; the repetition began to get a bit tedious.

I was also unable to INITIALISE any discs using this particular copy of MBASIC and therefore any disc access timing had to be carried out using one which was rather full. As a result any timings would have an unfavourable bias added to them, as compared to a virtually empty disc. To be fair to Heath, the disc was not write protected and so it is more than likely that somehow part of HDOS was clobbered; but I have to tell it how it is.

Booting up HDOS and loading in MBASIC left 21355 bytes free - MBASIC would seem to be therefore about 16K Bytes long. The tables show the available commands and also the benchmark timings. They are improvement on EBHB but still slow when compared with others. Many of the Microsoft facilities are provided plus

BASIC COMMANDS

Program development

AUTO	REM
DELETE	RENUM
EDIT	RUN
LIST	SAVE
LOAD	TROFF
NEW	TRON

Initialisation and assignment

CLEAR
LET
SWAP

Control structures

CONT	GOTO	ON ..GOSUB	STOP
END	IF ..GOTO	ON ..GOTO	
FOR ..NEXT	IF ..THEN.ELSE	RESUME	
GOSUB	MERGE	RETURN	

Machine level

DEF USR	OUT	POKE
INP	PEEK	USR

Input/output

CLOSE	INPUT	PRINT USING	TAB
DATA	KILL	PUT	WAIT
DIM	LINE INPUT	READ	WIDTH
EOF	LIST	RESTORE	
FIELD	OPEN	RSET	
GET	PRINT	SPC	

Functions

ABS	EXP	SGN	ASC	STRING\$
ATN	FIX	SIN	INSTR	
COS	INT	SQR	LEFT\$	STR\$
DEF FN	LOG	TAN	LEN\$	VAL\$
MOD	RND	VARPTR	CHR\$	SPACE\$
			MID\$	RIGHT\$

System

ERASE	LOC	RESET
ERL	LOF	SYSTEM
ERR	NAME	
ERROR	ON ERROR	GOTO
FREE	POS	

Conversions

CDBL	CVD	HEX\$	MKS\$
CINT	CVI	MKD\$	OCT\$
CSNG	CVS	MKI\$	

more besides. Notable features (for one reason or another) are as follows:

The error handling is among the best that I have seen. Virtually all errors can be trapped out - both for type of error and the line containing it. In addition, you can define your own error codes and messages and MBASIC even automatically traps out a non-numeric input when a numerical variable is expected. After the error handling has been "handled", the program can be told to RESUME from whichever line you wish - excellent. As far as numeric variables are concerned, the PRINT USING is rather more easy and flexible to use than some I have seen. You can even embed the PRINT USING format inside text - "I have ## apples" - but you can't use it with string variables.

One small quibble is that it is difficult to print -0.903E+02 . . . the computer prefers to print -.903E+02 which I personally find unclear. PRINT USING with strings is virtually useless as you can either just print the first letter in the string or the first n letters.

RENUMBER did not allow me to renumber a small section by itself in the middle of a program; LISTING does not always insert spaces between reserved words (unlike some other BASICs) and so to maintain readability, spaces need to be included in the statement; which costs a slight overhead in extra memory. The provision of decimal to hex conversion was a very pleasant surprise, mak-

ing the use of Octal elsewhere seem even more silly.

The usual arrays can be used, including multi-dimensional string arrays — i.e. A\$(X,Y,Z) — but a slight drawback is that you rapidly run out of reserved string space (as MBASIC doesn't automatically alter the amount of memory reserved for strings dynamically). You get round it by specifying CLEAR XXXX but it's a bit tedious and gives the programmer something else to worry about which to my mind is unnecessary. Numerical variables can either be integer, single or double precision but you can't define them once and for all — you always have to add the suffixes to each variable. The accuracy of the double precision needs improving. For instance, $1.987 \div 0.987$ yields 2.013171116905303 (work it out!). Only radians are supported by trig functions.

MBASIC has the added bonus of an Editor, which can either be summoned via EDIT (line no.) or entered automatically during RUN when a SYNTAX ERROR occurs. The faulty line number is printed out but not the statement, which is a pity. No clues are given as to the offending portion of the statement and there are virtually no checks for syntax when the statement lines are entered.

The MBASIC disc accessing is fast but fiddly to use. It supports either sequential files or random access; the random access records are fixed length at 256 bytes — a bit of a shame. A FIELD statement will allocate x bytes as A\$, the next y bytes as B\$ etc., but care is needed with any subsequent references to A\$ and B\$ and so, normally, any input statements (from the keyboard) are made into X\$ and Y\$ and then a second statement using LSET A\$-X\$. . . which is fiddly. All numerical variables have to be converted into strings before being stored onto disc, and then reconverted back into numbers when they are read back. You have to remember to do this and it's a chore. One ends up writing about three times as much program as should be necessary. Any number of files can be opened although only one can be open for output.

Having said all that, as the figures show, it's quite respectably fast at storing and retrieving 100 records of 256 bytes and also it is truly "random". A pity then that you can't call for a CATalog of the files on the disc from MBASIC! You have to return to HDOS, CAT and then reload MBASIC. This omission I found rather irritating. However, Heath do say that CP/M will shortly be released; it will be interesting to see what improvements that will bring.

Other languages and software

Apart from CP/M, the only package that Heath have announced is a word-processing package called Autocrisbe that's designed to be used with a Diablo printer. Dual 8" disc drives with 1M byte of storage are expected next March. Heath supplied one of their printers for review but forgot to include any ribbon; therefore I couldn't review it.

Some general views of the WH-89. Notice the special function keys on the top row of the keyboard. The insides are easily accessible via a hinged and removable casing. Finally, please note that, just as we started the Benchtest, the Heath company went through a few changes (see Newsprint). The upshot as far as we're concerned here is that the logo on the cabinet has since changed to Zenith Computer Products.

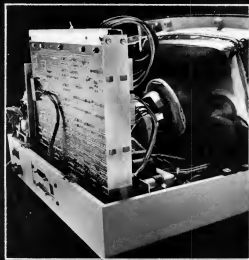

Photography by Ian Dobbie

Business & education potential

It's difficult to give an accurate assessment. Heath would seem to have already realised the business limitations inherent in the single disc concept and the software does make provision for other drives; it would be interesting to look at this machine again when the 8" drives are available. At the moment, business packages are rather thin on the ground — in fact I don't know of any — but hopefully the release of CP/M should solve that. It has many extra facilities that are often lacking on other machines but this can cloud the issue; it may require a greater amount of knowledge to effectively use it. It is not a machine that I could recommend for the beginner.

Documentation

The documentation is very good. The program manuals are well laid out and the indices, most comprehensive. The operation/service manual is also good and provides a useful background to how the computer works. At times, however, the order of presentation is a

little peculiar. . . for example, the appendix is in the middle! The blue service manual (not normally supplied) is superb and even provides specifications and data sheets on all the devices used. My only (minor) quibble is the constant reference throughout all the texts and diagrams to U 512, U 608 etc. You have to keep looking up in the tables to see that U512 is really a 74LS74.

Conclusion

The WH-89 is an all-in-one computer that has the added advantage of being usable as an intelligent terminal into a different computer. The VDU section boasts many extra features not normally found, as does the computer itself. It needs to be "intelligently" treated in order to realise its full potential — at which time the "niggles" and minor irritations should take on a different perspective. However, I do have some reservations on the apparent lack of software support for business users.

Thanks go to Heath (Gloucester) — and in particular to Tony Smithson — for help received during the compiling of this Benchtest.

PRICES (Excluding VAT)	
16K WH-89	£1490 Assembled
plus serial interface	80
16K extra RAM	70
cassette interface	78
Kit version (H-88) (without floppy disc)	948
HDOS & EBHB	60 Not supplied with WH-89
MBASIC	60
Total price of review sample £1830	

At a glance

FIRST IMPRESSIONS	
Looks	***
Setting up	***
Ease of use	**
HIGH LEVEL LANGUAGES	
Basic	****
Cobol	N/A
Fortran	N/A
Pascal	N/A
Other	N/A
System Software	***

PACKAGES	
Business	N/A
Education	N/A
Home	N/A
Games	N/A

PERFORMANCE	
Processor	****
Cassette	not tested
Disc	***
Peripherals	not tested

EXPANDABILITY	
Memory	***
Cassettes	not tested
Discs	***
Bus	***

COMPATIBILITY	
Hardware	***
Software	**

DOCUMENTATION	

VALUE FOR MONEY	

****	excellent
****	v. good
***	good
**	fair
*	poor

Benchmark timings

Benchmark Timings (in seconds)			
	EBHB	MBASIC	
BM 1	4.1	2.5	
BM 2	17.0	9.2	
BM 3	35.0	25.3	
BM 4	38.8	26.0	
BM 5	44.0	27.0	
BM 6	75.8	46.6	
BM 7	113.0	73.2	
BM 8	11.0	13.0	

As PCW has recently received two letters* criticising the Benchtest of the Challenger C3 S1 we feel that we should make a few points clear.

- All information is based on that provided by the supplier of the review machine. We do, of course, check back with the supplier when encountering any oddities, anomalies or whatever.
- Our Benchtest is a report of the reviewer's experience with the machine and any other materials and equipment supplied with it.
- We do not review promises, although we may comment that certain things are on the way. Again, this information is based on that provided by the supplier of the machine.
- We review a machine against the claims made for it. That is to say that if a machine is claimed to be aimed at the inexperienced user, as many micros are, then we tend to be critical of those aspects which require, for example, the attention of the programmer — Ed.

*The letters came from suppliers of the C3 S1, namely, MUTEK of Corsham, Wiltshire and U-Microcomputers of Northwich, Cheshire.



Malcolm Peltu takes as his theme this month, the publishing of a new book from Adam Osborne. It's Osborne's first significant departure from straight fact and marks his arrival in the ranks of the "professional speculator".

Wild and wooly

Adam Osborne has built a powerful reputation as a writer and publisher of lucid textbooks introducing the technical aspects of microelectronics and microprocessors. It is therefore surprising that his first venture into the wider field of the economic and social impact of technology should be a turgid mish-mash of superficial, badly organised and often misleading punditry.

Called *Running Wild*, Osborne's contribution to the Great Microelectronics Debate comes complete with a puff saying that it has been written for the layman — "to educate and help prepare today's citizen for the coming twenty-five years". Even though some of the issues he highlights are of vital significance to the future, the way in which he offers top-of-the-head guesstimates and throw-away observations as if his "reputation" absolves him from providing analytical justifications to his views makes me reluctant to recommend the book as a preparation for the next twenty-five microseconds.

Running Wild covers terrain that by now should be familiar to a British audience which has recently been provided with an abundance of media coverage on the impact of the dreaded (or eagerly-awaited, according to taste) silicon chip. Yet Osborne concludes, "No one is paying attention to the way in which microelectronics and computers are being used, or to the impact such uses might have on our society. We had better start paying attention, or we will be very, very sorry".

Running Wild seems to have been written by throwing text into a word processor and then joining it together in haste. Open the book at any page and you will find crisply written sentences, racily strung together and apparently making a point clearly. But read sequentially it is tough going because it has little internal structure and rhythm and is frequently contradictory.

For example, Osborne often says that 50% of all current jobs could be

eliminated within 25 years, totalling around 50 million jobs in America alone. Yet in the chapter on "The White Collar Future", he states, "But when push comes to shove, microelectronics and automation will not have a dramatic impact on office jobs. Fewer secretaries will be needed - but they are in short supply anyway. Fewer file clerks will be needed and low-level office positions may be eliminated. Office jobs will be more demanding, and office personnel will require more education, but there will be no significant decline in the number of jobs".

Note the utter certainty with which the statement is made. No ifs, buts or supportive evidence, even though in a different chapter he estimates that almost 45% of all professional, managerial and administrative white collar workers will lose their jobs.

Serious studies of the impact of microelectronics, such as *Automatic Unemployment* by Colin Hines and Graham Searle and *The Collapse of Work* by Clive Jenkins and Barrie Sherman (reviewed in PCW September and October 1979), clearly show that the most revolutionary impact of the technology is likely to be in office and white collar jobs. These have been the under-automated, labour intensive activities which soaked up the unemployment created by the switch away from employment in agriculture and manufacturing industry which has occurred this century.

Unlike *Running Wild*, these other books try to back up their conclusions with some facts and figures. Osborne seldom bothers, even though he acknowledges that he had two 'research editors' to help him. Some of their research appears to extend little further than Prestel information from the British Post Office.

At the end of the chapter on the white collar future, Osborne does a standard Tomorrow's World-style round up of the way in which computer terminals in the home will enable people to shop, find jobs, book airline tickets, look up electronic news services, etc.

He concludes: "We can argue about the way in which computer terminals will be used in homes and offices, but there is no argument that homes and offices will all have computer terminals. It is already happening - particularly in Europe. The trend in Europe began in Britain with a system called Viewdata, which transmits written material via telephone lines to television sets all over



Britain. Any Briton whose television set is appropriately equipped can read news bulletins or the weather forecast; he or she can buy a variety of products or use various services. In short, he or she can already do most of the things described in the preceding pages".

This gives a misleading impression of the Prestel reality and is just one example of where technological potential is confused with technical economic and social reality.

The best parts of *Running Wild* (not surprisingly, given Osborne's background in the microcomputer business) are the early chapters which sketch in the historical development of Silicon Valley, micro games and the emergence of the hobbyist market led by MITS and Altair. In contrast to the rest of the book, these chapters have substance and character, filled with intriguing anecdotal material about the people who, in the heady days of the mid-1970s, started the whole new industry with names like Apple, North Star, Radio Shack, Pet and all those others which now fill the pages of PCW.

Although this material is interesting, it has little to do with the rest of the book, except as an illustration of the new industries the

technology can create. To go into detail about the hobbyist market while covering other important areas so superficially is a distortion of the weights that should be given to a book that claims to be about the next industrial revolution.

These enjoyable opening chapters, one of which is trendily called *Roots*, are followed by a dreadful chapter on computer intelligence which somehow contrives to turn the exciting subject of artificial intelligence into a boring and detailed plod through the logic used by computers to add numbers together. He does this to try to illustrate the "garbage in/garbage out", our computer-is-a-programmed-idiot principle. There seems little excuse, other than having a handy chunk of text in the word processor, to go into such great detail on such a relatively unimportant topic.

Osborne shows little insight into modern developments in artificial intelligence — such as "expert systems" which are programmed with human reasoning. It is also unclear why the chapter on computer intelligence, containing its heavy-going logic analysis, should come so near the beginning of the book when the more relevant and entertaining description of micro-

BOOKFARE

electronics is confined to an Appendix.

The section I personally find most amazing in this hotch-potch book is where Osborne looks at the three areas in which the applications of computers and microelectronics should be excluded. Aha! I thought, now we can look at some real computer abuses, like the computers in defence systems that nearly caused World War 3 or the invasion of privacy by unwarranted access to medical files or the use of computers by dictatorships to infringe human rights. I was wrong. . . Osborne's three nasties are concerned with three American obsessions - democracy, money and business.

Bank computers from being used to count election results, to transfer money, and in the central operations of stock exchanges, says Osborne. His main concern is that in these three areas, computers can be introduced with a view to fake the results or commit frauds. This danger, although, of course quite real, applies to most other uses of computers. For someone who later (in the same chapter) goes on to ridicule attempts to regulate computer crime because the laws do not differentiate between illegally producing a Snoopy printout and a financial fraud, Osborne shows barefaced cheek in suggesting glibly that all electronic fund transfers should be outlawed.

Besides being totally impractical - given the bank's investment in computers and the difficulty of monitoring the flow of digital information to see if the transaction is a money transfer, a letter, or anything else - this suggestion also contradicts Osborne's own enthusiasm for home-based shopping, which he believes is so rife in England.

Osborne and his research editors are clearly out of their depth in *Running Wild*. Its glib and crisp style might suit an American public whose minds are incapable of assimilating more than the five-minute gobs of information spat out from their TV sets between advertisements; but, it cannot be considered as a serious contribution to the debate and analysis concerning the impact of information technology, particularly when there is such a substantial and growing range of books that examine the issues with depth and subtlety. *Running Wild* is to these other books as *The Beano* is to Dickens.

Compiling sins

My original sin was to believe in the infallibility of I, the Programmer. Then I believed in my inherent programming frailty and the Rightness of the Machine. But my faith was shattered by the realisation

that the Compiler is not of the Machine but is merely mortal software.

That cycle of illusion and disillusion is probably true of anyone new to programming. The first time a program goes wrong, the Virgin Programmer instinctively feels that the machine is at fault, not his or her own perfect logic. After the first debug, however, it becomes evident that the fault lies closer to home.

But I felt a real shock when I first realised that the compiler was not an inherent part of the Machine. I was working for a manufacturer and when one day a program went wrong and we couldn't find out why, someone suggested we go to the compiler support team. Sure enough, the cause was a bug in the compiler.

In those days of about a decade or so ago, compiler writers, like the compilers they wrote, were regarded with awe in the computer profession, being only one step removed from those arch high priests, the operating system writers. It would have seemed unbelievable then that anybody could conceive of writing their own compiler. Even more unlikely was that one day someone would write a book on how to do just that - and what is more, a book that is as intelligible, intelligent and (miracle of miracles) as witty as *Peter Brown's Writing Interactive Compilers and Interpreters*.

This, for me, is a rare publication because it is a "straight" technical book which I actually enjoyed reading. The hobbyist world has, of course, produced many relaxed, colloquial, cartoon-filled, jokey books. But Brown's effort is in the more academic tradition of the mainframe computer world, yet it manages to appeal to the "lay" personal computer enthusiast and the professional programmer.

The tone of the book is captured by its fourteen deadly sins which pepper the text. The first deadly sin, for example, is "to code before you think" and the last is "not to read to the end of the book" (which appears as the last line on the last page). The "sins" are a vivid way of encapsulating important advice without being patronising or hectoring, while the last of the deadly sins shows that Brown has a comedian's wit and sense of timing.

The book works on two levels; as a general introduction to computer concepts and as a practical guide to a programmer wishing to actually write a compiler. The practical examples relate to BASIC and the guidelines provided are never dogmatic. Brown is not afraid to recommend one approach

Continued on Page 87



RE-FURBISHED IBM SELECTRIC TYPEWRITER TERMINALS

Two versions are available

RO £745

with full typewriter facilities and built-in interface, this version is compatible with most microsystems such as Apple, Pet, Tandy, etc., and does not require any further interface card, as it connects directly into the bus on PET, the cassette port on Tandy and the games port on the Apple II. Other computers may be connected using an RS232 interface at 300 or 2400 baud, providing the interface uses 'Clear to Send' signal. It is emphasised that the keyboard is retained and this terminal may be used as an office typewriter.

KSR £845

with full typewriter facilities and built-in RS232 interface. A serial interface may be needed depending on the computer used.

Attention all Apple II owners

A word processing package is now available for the Apple II at only £120, and together with our hardware modification giving upper and lower case at £80, you can turn your Apple II Computer into a powerful word processor.



Contact:
Vlasak Electronics Ltd.
Thames Building,
Dedmere Road,
Marlow, Bucks.
Tel. Marlow 74789

ASK YOUR DEALER FOR VLASAK/SOFTWARE
DEMONSTRATION

PURCHASE LEDGER

Compiled and edited by Mike Knight of Mike Rose Micros.

One of the enigmas of most businesses is that our customers expect us to give them unlimited credit for what seems like unlimited periods of time but our suppliers expect us, as customers, to pay our accounts as soon as they are rendered. Of course none of us really like paying bills but unfortunately in both good and bad times we depend to a great extent on the goodwill of our suppliers. In good times we need to be able to increase our material supplies to meet the needs of our expanding markets. In bad times an extra month's credit can sometimes mean the difference between solvency and having the receivers in. In both cases our credit rating will probably have been built up

over a number of years of prompt payments. In fact in those industries where prompt payment discounts are the norm, controlling the payments we make to our suppliers may actually increase our profits. In this month's Systems we are therefore going to look at Purchase Ledger.

Objectives of purchase ledger

To control and record details of monies owed by a company for materials, services or goods supplied to it.

In the last Systems I dealt with Sales Ledger; Purchase Ledger can be

considered as the other side of the cash flow equation and when the management information it can provide is used together with labour costs, it plays a major part in determining pricing strategy.

Functional requirements

The requirements may be summarised as follows:

1. We must be able to keep details of all our suppliers, adding new ones, removing those we no longer use and making amendments to our existing ones when necessary.
2. We must be able to post all transactions concerning our suppliers to their accounts whether they are invoices, credit notes, cash payments made, discounts taken, or simple adjustments.
3. We should be able to determine priorities in the payment of our accounts and so we would expect to be able to quickly see those accounts which have been outstanding over a certain time, or those which are over or under a pre-determined control amount.
4. We may wish to produce cheques or Giro credits automatically.
5. If required, statements and/or remittance advices should be produced.
6. We should be able to analyse our payments and/or balances against the appropriate nominal account headings.
7. We may wish to use the details of our purchase transactions to compute accurately the up-to-date cost of our stock holding.
8. We may like to choose between a forward balance or an open item system.
9. Finally we don't want to lose the advantage of our manual systems in being able to easily look at any individual account.

In the next two sections we will see how new packages meet these requirements.

Evaluations

VLASAK PURCHASE ACCOUNTING PACKAGE

This is available direct from Vlasak Elec-

Tasks and volumes

TASKS	VLASAK	HB COMPUTERS	PETSOFT CASSETTE	DISC	PETACT	PAXTON	SERENDIPITY	SAIL	BENCHMARK
Update Supplier file	0	0	0	0	0	0	0	0	0
Post transactions — invoices	0	0	0	0	0	0	0	0	0
credits	0	0	0	0	0	0	0	0	0
cash	0	0	0	0	0	0	0	0	0
discount	0	0	0	0	0	0	0	0	0
adjustments	0	0	0	0	0	0	0	0	0
Print Remittance advices	0	0	0	0	0	0	0	0	0
Statements	0						0		0
Supplier list					0	0	0	0	0
VAT audit		0							0
Aged balances	0	0	0	0	0	0	0	0	0
Payment list			0	0	0				0
Control list		0	0	0	0	0	0	0	0
Cheques			0	0	0	0	0	0	0
Ledger cards			0	0	0			0	
Enquiries	0	0	0	0	0	0	0	0	0
Accounting system — balance fwd	0	0	0	0	0	0			0
open item								0	

VOLUMES

A = alphabetic N = numeric	VLASAK	HB COMPUTERS	PETSOFT CASSETTE	PETSOFT DISC	PETACT	PAXTON	SERENDIPITY	SAIL	BENCHMARK
Account number	3N	4N	3N	1A3N	1A3N	4A2N	8AN	5N	4N
Balance maximum	£1M	£100K	£1M	£1M	£1M	£100K	£100M	£10M	£1M
No. accounts max	200	900	200	1000	2500	600	1500	1000	500
No. transactions	1000	4000	1000	3250	6500	3000	3000	2000	2000
Name/address size	160	85	115	115	115	78		100	76
COSTS									
Package cost (£)	315	350	95	115	350		275	625	250
Hardware cost Min (£)	3350	2400	1450	2250	2345		3000	3500	3600
Total cost (£)	3665	2750	1545	2365	2695	4750	3275	4125	3850

SYSTEMS

tronics Limited, Marlow, Bucks (06284 74789) or from their dealers throughout England and Scotland. The package is designed to be fully integrated with their Sales and Nominal Ledgers but is available as stand alone at a cost of £315. It was first released in November and has ten users at present. The package is written in BASIC and is supplied with systems and operating manuals. Requests for customisation are always considered and quotations are made according to the amount of work involved. At Vlasak, whilst they believe their package covers all normal requirements, they don't pretend to be infallible and if a customer came up with a requirement which they feel would enhance their product they are quite liable to incorporate it free of charge.

The minimum hardware to run their system is a 48K Apple II, two disc drives and a 132 column printer, which altogether costs £3,350. Included in the cost of the software is free training which can be on site or at Marlow. They expect to sell hardware and software together and offer two types of maintenance contract — one costing 5% of the purchase price per annum which provides a repair service either in house or on site, and the other costing 10% per annum which guarantees a replacement service within 24 hours.

SERENDIPITY SYSTEMS INC ACCOUNTS PAYABLE

This American produced package has been introduced to this country by Great Northern Computer Services Limited, Leeds. (0532 450667) They have completely Anglicised the package together with another eight Serendipity packages and have negotiated an exclusive distributorship for these products throughout the United Kingdom and Ireland. Great Northern's objective is to establish about thirty dealers countrywide and to date they have already covered all of England and Scotland above a line from the Severn to the Wash. There are twelve users in the UK and over two thousand in the United States.

The package costs £275 and can be supplied in CBASIC, Cromemco Extended BASIC and North Star BASIC. The minimum hardware requirement is 48K, dual floppies, VDU or 80 column printer — costing between £3,000 and £6,000. Great Northern supply their dealers with source code and user manuals and provide a full time enquiry service as back up. Installation, training and maintenance services depend on the policy of each individual dealer.

PAXTON COMPUTERS PURCHASE LEDGER

This is available direct from Paxton Computers Limited, St. Neots, Huntingdon, Cambs, (0480 213785) or from their dealers throughout Britain. The package can be purchased for £750 but is normally sold together with Sales Ledger; the minimum hardware is: 48K North Star Horizon, 2 floppy discs, VDU and printer at an inclusive cost of £4,750. The package is written in North Star BASIC with some assembler modules.

Although there are ten programs in

the suite this would be transparent to the user since control is always returned to the Menu program. In fact control of the programs is never handed over to either the BASIC interpreter or the operating system (usually CP/M); this is to ensure that mis-operation will not corrupt data.

Paxton's major selling claim is the resilience of their software: "So far no system of ours has crashed through keyboard action, and they retain data integrity even through disc faults". Their claim looks valid since incomplete processing is detected automatically by the software. The package has been available since July 1979 and there are eighteen users.

Their operating manual is designed primarily for the inexperienced user and whilst I believe they have succeeded in this objective, even experienced users have been tempted to disobey their exhortation that, in the event of breakdown, one doesn't kick the computer or punch the VDU. Included in the software cost is a half day's operating training on installation and another half day on the system, usually about two weeks after installation.

SAIL PURCHASES LEDGER

This is available direct from Software Aids International Limited, London N.16 (01-359 2818) or from any of their franchisees in Manchester, Cambridge, Harlow or Horsham. The package is written in Microfocus CIS COBOL and will run on any machine using the CPM operating system. The cost is £625 and the minimum hardware configuration is 32K, dual disc drives and a VDU, (a Printer is optional) — costing approximately £3,500.

Personalisation is included in the cost of the package, but customisation would be charged at normal market rates. Also included are up to five man days of installation support on site and as much training on the systems as is required. Maintenance is provided for one year free of charge. Users are supplied with operating instructions and a user system manual and, since it's a conversion from an existing main frame system, the documentation is pretty comprehensive.

HBC PURCHASE LEDGER

This is available direct from HB Computers Limited, Kettering, Northants, (0536 83922), or from their expanding number of distributors throughout the country. The package costs £350, was introduced in July 1979, and there are twelve users to date. The cost of the package includes half a day installation if the hardware is purchased at the same time and the minimum hardware required is a CBM 3032 computer (32K PET), Computhink 5¼" dual drive disc system and any PET compatible printer, all costing from £2,400.

The system has been designed with ease of use as the priority and as such, customisation has taken a back seat. Formal training is not provided but the manual is considered to be comprehensive and a telephone backup service is provided. Any software bugs found would be fixed immediately free of charge since HB are aware that their

marketing efforts depend on bug free software. HB also supply a Sales Ledger package at the same price but if Purchase and Sales Ledger are purchased together then there is a discounted price of £500 for both.

PETSOFT PURCHASE LEDGERS

Two purchase ledger packages are available from Petsoft, Newbury (0635 201131) one uses cassette and the other, Commodore discs. The costs of the packages are £95 the cassette version and £115 the disc. Both packages have over a hundred users and can also be purchased from any of Petsoft's 250 dealers throughout the country. The user is provided with an operating manual but systems information is limited. The minimum configuration is 32K Pet, printer and either cassette or Commodore dual disc drives and costs £1,450 for the cassette system or £2,250 for the disc system. Bugs are corrected free of charge but Petsoft offer no customisation service.

PETAFACT PURCHASE LEDGER

This is available direct from Petafact Business Systems, Birmingham (021 454 5348) or like their subsidiary Petsoft, from any of their 250 dealers throughout the country. The package costs £350 and it's a conversion from a well established mainframe system which has been in use for over 15 years. The cost of the package includes a one day training course at Birmingham and is designed particularly for the first time user.

The minimum configuration is 32K Pet, 80 column printer and dual Compu/Think disc drives. The facilities provided are very similar to the Petsoft systems but instead of five individual programs for the functions there are nine, all of which are driven via a menu selection program. Once again bugs are corrected free of charge but no customisation service is provided.

BENCHMARK 'SNIP'

SNIP is a fully integrated Sales, Nominal, Inventory, and Purchases system which costs £950. Each package, however, is available stand alone from the writers of the software: Benchmark Computer Systems Limited, St. Austell, Cornwall (0726 61000) — purchase ledger costs £260. The system is supplied with all media — including security discs, systems specification and operating instructions. The cost of the package includes an installation service and personalisation.

The minimum hardware required is 32K North Star Horizon, 2 disc drives, VDU and printer, costing £3,600 (including delivery and installation). Bugs are corrected free of charge during a 90-day warranty period but outside this users are notified and are offered the amended program on a diskette — at the price of the diskette. I really must comment on the excellent standard of the systems documentation; it contains not only a good overview but also full file details and sample output. The documentation has obviously been produced using their word processing system which I will be reviewing when I cover that topic in two months' time.

See Page 100 "Bludners"



COMPUTER ANSWERS

Each month Sheridan Williams and his panel of consultants answer readers questions. Topics may be hardware — from kits to mainframes, or software — from differential equations and statistics to file handling or sorting; the choice is yours. Send your questions direct to Sheridan Williams at 35 St Julians Road, St. Albans Herts.

Tied up with strings

There is one thing that puzzles me about microcomputer programs regarding their string handling. Could you please explain why it is not possible to refer to the n th character in $A\$(n,n)$? I am considering buying a PET but I can only see mention of LEFTS, MIDS and RIGHTS. Does this mean that it is not possible to use the $A\$(n,n)$ format?

H. Frost, Crawley, Sussex

It's not the computer that provides the differences found in string handling, it's the compiler/interpreter; so the way in which strings are handled is independent of whether the computer is a micro or a mainframe. You have encountered one of the many areas of BASIC which are undefined. String handling in one version of BASIC is quite likely to be different to string handling on another machine, even on the same machine you can get different versions of BASIC, each with its own rules. You have, in fact, met one of the less frequent types of BASIC and it is comparatively rare to find a micro that does not use the LEFT MID RIGHT system. I won't give any examples here because virtually any book on BASIC will use the LEFT MID RIGHT system, it is as if I told you to try it as it is only good if not better than your system.

No go

I am considering the purchase of a personal computer and, this being a new venture, I require some advice. My price range is £1000-£1250 and this puts the PET, Apple etc. in my class. One of my prime uses will be the playing of games such as Chess, and particularly GO (not Gomoku or Go Bang). Are you aware of any games for GO on personal computers? A letter to Compuseries elicited no response whatsoever.

I. Jones, Guynedd, Wales

I am afraid that I know of no programs that have been

written for GO. You may care to ask the British GO Association, 16 Wantage Rd., Reading, Berks to see if they have any more information. Both the PET and the Apple (or ITT 2020) graphics board should be able to display the board and pieces etc, but personally I prefer the extra facilities that the Apple provides.

Writing your own program is the answer — preferably with large chunks written in machine-code to speed up the program. It may be tricky writing the part of the program that looks for 'eyes' within the opponent's — but by no means impossible. If any of our readers have any more information to add then I'll gladly pass it on. By the way, writing in machine code is very much easier on the Apple than on the PET. Also, if you are considering expanding to floppy discs at some future date then I would have to recommend the Apple's discs in preference to PET's own discs.

Mike Dennis

Schoolpleas

The maths department at my school are indecisive as to whether to buy a PET or an Apple or even whether to buy a computer at all. Would pupils soon learn to write useful programs? The school has about 1,000 pupils. How can we raise the money?

T. Lord, Cūtheroe, Lancs

In trying to answer your question I will get onto my hobby horse yet again and say that if industry expects and requires programmers, computer engineers and all the other job categories then it had better start to do something about training now. Approach some local industry and say "I would like a contribution towards a microcomputer pleases". Remember that it is in their interest to help because you are training their future employees; it only needs a couple of far-sighted firms to contribute and you will soon have a computer.

I think it is appalling that industry is unwilling to help; to get an idea of the attitude of many companies that employ computer personnel, look for vacancies for TRAINEE programmers — they don't exist; how can we hope to fill the dearth of computer professionals if no-one is prepared to help.

Now I've got that off my chest I will try and answer your other questions. Don't be indecisive — buy a compu-

ter. A school is supposed to educate and a computer is an educative tool. It can be used both to teach computing and also to teach other subjects. There is a growing awareness in ALE (Computer Assisted Learning) and already there are packages available, provided that you have a suitable machine. I am not sure why you are reduced to the choice between Apple and PET. . . There are many other micros on the market in that price range. I have my views on the APPLE and the PET but would not like to recommend one in preference to the other without asking several more pertinent questions; go and look at other machines too.

As to the question of whether the students would soon learn to write useful programs, that's up to you. With your guidance and the correct motivation the answer is certainly yes, but leave them alone and all you will probably get out of them is games. Games stimulate learning but by giving them useful objectives you can get amazing things done. Those students that show an aptitude will learn at a frightening rate and unless you have someone on the staff with a fair amount of knowledge they will overtake you at an exponential rate; their brains are still at their peak.

This brings me to another of my worries. Is there anyone available to answer their questions? They'll learn far more slowly by trial and error. We clearly need more trained computer teachers, but with their pay so far behind that of industry, the reason for the shortage is obvious.

SW

Policy making

I work in an insurance brokers. In my spare time I have developed a BASIC program which helps produce insurance quotations. It substantially reduces the time taken to prepare a quote. I am sure it could be of use to many people working in insurance broker offices. I would like some advice on marketing/distributing my program. I am particularly worried about people taking unauthorised copies without paying for them.

A. James, London N4

I can see a number of paths which you could follow. The simplest would be to sell your program to one of the specialist micro software shops; they are geared up to advertising specialist packages like yours.

Speaking from personal experience, you may have trouble obtaining what you consider to be a 'fair' price for your rather specialised program. However, if your package is well presented, (documented/programmed) then you may manage to interest one of the larger software shops who will act as distributor, and pay you a royalty for each program sold. I think that they will only handle really high quality software in this way.

Secondly, have you thought of handling the sales inside the trade?

Perhaps your company could be willing to buy a number of machines and install your software on them. Alternatively, you could approach an insurance company and see if they are willing to buy your program through a network of brokers who are willing to buy their own machines (if it really is cost effective, people will put their money out).

On your point of stopping possible thefts (unauthorised copies) the best way to investigate the possibility of placing your program (or part of it) into a PROM. This would not make copying impossible, but for most users, it would be easier to buy the program than steal it. You failed to mention the machine on which you have developed your program. I can therefore only give some general points on PROM encoding. PROM programmers can be bought for most microcs, and the actual interfacing to a Bus/Port is straightforward. Typical cost of a programmer is £38.50. You would write into the PROM (in machine code), one or two of your BASIC subroutines, and replace their calls with calls to the PROM code. An alternative method I have seen working involved storing the program's data in a coded form on cassette (or another PROM) and using a PROM subroutine to access and decode it. This works best where the data is complicated (time consuming to prepare) and does not need to be updated by the user; by another PROM arrangement would require that data be easily altered. As I have already said, these methods are not totally secure. Best would be to encapsulate the whole program in ROMs soldered into the machine, ensuring that there is no way in which users could examine the machine's store without physically removing the chips.

Jon R. Malone

COMPUTER ANSWERS

Taping it

As a newcomer to micro-computing I would like you to answer some questions regarding cassette mechanisms. I understand that there are audio drives and digital drives and that's about my limit. What are the differences in speed, reliability, method of operation and cost? Can cassettes written on one type of drive be read by others of the same type? What I am leading up to is to ask how easy it is to exchange program and data between different systems? *F. Carlson, Battersea*

As you say, there are two basic recording formats (sometimes referred to as digital and audio); there are also two basic kinds of cassette mechanisms. The difference between them is that digital recording techniques originate on mini computers (PDPs/Data Generals etc) whereas the audio system came along as the cheaper alternative and was based around standard household cassette recorders.

There are a number of physical differences between the two mechanisms. Digital drives are normally based around expensive, servo controlled, linear DC motors. These can accelerate the tape quickly and position it accurately at high speed. By comparison, audio drives use standard motors which cannot be so carefully controlled; nor will they operate at such high speeds. The speed of the drive is important if high packing density and fast data transfer rates are to be achieved.

Digital drives tend to use reel-to-reel tape mechanisms, where the hubs are used to move the tape. Audio drives use pinch rollers to move the tapes — these can stretch (and chew!) tapes.

Table 1 summarises the specification differences between typical digital/ audio drives. By reliability I presume you are referring to the frequency of information loss rather than to mechanical reliability. With most cassette systems it is possible (with varying degrees of effort) to record

your own check data on the cassettes and thus the sky is the limit. You could, for example, record each character a number of times and include checksums and parity bits. Those allow software to detect and then correct errors in the data. A particularly simple method (which wastes a lot of space) is to record each data block 3 times on the tape. If any discrepancies occur when you read back the data, the majority vote (2 out of 3) wins. Buying high quality cassettes (try to get 100% certified computer grade tapes if possible) will help reduce data loss.

The method of operation of the cassettes is normally very similar to programming a teletype! After a transfer has been initiated the hardware will set a flag when it is ready to receive/transmit a character; the software writes/reads the next character to/from a suitable location. Obviously there are a number of time limitations imposed by the hardware, e.g. you must supply the next character within 10 milliseconds of the hardware requesting it. To save programming effort and to remove a source of error, many tape drives come with software which provides a "block" interface. You simply tell the software where a block is; and whether it is to be read/written and leave the rest up to it. Blocks are normally 80-150 characters long.

This leads up to your final point — the interchange of tapes between machines. Transfer between digital and audio systems is not possible. There is little trouble transferring information between machines of the same make. Similarly exchange between hardware which uses the "Kansas City Format" can also be straight forward. Unfortunately a number of micros use their own internal code when writing information to tape. (It has the advantage that they can replace long commands like "PRINT" and "GOSUB" with single characters). This makes the operations of saving and loading programs much faster. *Jon R. Malone*

Table 1 A comparison of Digital/Audio cassettes

	High Quality Drive	Audio Drive
Tape length	150 feet	280 feet
Tape type	High quality, Computer grade, 100% Certified	C30—(say)
Tape speeds:		
Read/write	9 inches/sec	1.9 inches/sec
Search	20 inches/sec	No corresponding
Rewind	100 inches/sec	50 inches/sec
Time on one tape	3.5mins	30mins
Rewind time	20 secs	60 secs
Tape capacity	92K bytes	120K bytes
Typical Baud Rate	4000 Baud	650 Baud
Density	500 bits/sec	400 bits/sec
Approximate cost	£1000	£50

Up-to-date-Micro/Mini Books

Lance A. Leventhal
Introduction to Microprocessors:
 Software, Hardware Programming
 'a comprehensive and practical user's guide'
 Computer Products International

£15.55 Hb 13-48788-X 640 pages £8.95 Pb 13-48787-0

James R. Huffman

Personal Computing

Complete plans for building a microcomputer are given as well as programming instructions.
 £10.35 Hb 8359-5516-8 262 pages £7.75 Pb 8359-5515-X

Richard H. Eckhouse Jr. and L. Robert Morris
Minicomputer Systems:
 Organization, Programming and Applications (PDP 11) Second Edition
 £14.90 Hb 13-585919-9 512 pages

Cay Weinman

Distributed Micro/Minicomputer Systems:

Structure, Implementation and Application
 £14.65 Hb 13-216481-7 416 pages To be published in March 1980

Ronald Tocci and Lester P. Laskowski

Microprocessors and Microcomputers:

Hardware and Software
 Highly illustrated with diagrams and flowcharts.
 £10.75 Hb 13-581249-6 320 pages

Jefferson C. Boyce

Microprocessor and Microcomputer Basics

A comprehensive introduction to both hardware and software.
 £11.00 Hb 13-581249-6 320 pages

Lou Frenzel

Getting Acquainted with Microcomputers

'For someone who has a reasonable background knowledge of computer hardware this book will form an excellent introduction to microcomputers.' Practical Computing
 £5.80 Pb 672-21496-5 288 pages

Mitchell Waite and Michael Pardee

Your Own Computer

Both software and hardware are explained in detail as well as uses of the computer.
 £1.25 Pb 672-21483-0 80 pages

Lance A. Leventhal and Colin Walsh

Microcomputer Experimentation with the Intel SDK-85

Over 70 fully documented sample programs are included.
 £9.05 Hb 13-580866-X 384 pages To be published in March 1980

T. Dollhoff

16-Bit Microprocessor Architecture

Programming examples and instruction set summaries for major 8 and 16-bit microprocessors.
 £16.20 Hb 8359-7001-9 560 pages

Robert Bruce

Software Debugging for Microcomputers

The author describes how to write programs in BASIC and use the machine for increasingly complex applications.
 £12.30 Hb 8359-7021-3 416 pages £7.10 Pb 8359-7020-5

Stanley J. Evans

Microprogramming:

Techniques with Sample Programs
 Popular languages such as BASIC and APL/M are used in this up-to-date handbook.
 £9.70 Hb 8359-4373-9 224 pages

Richard Conway and David Gries

Programming the Microcomputer:

A Structured Approach Using PL/M
 £11.65 Hb 87626-721-5 495 pages

David Larsen, Peter Rony, Jonathan and Christopher Titus

8080/8085 Software Design

£6.20 Pb 672-21541-1 304 pages

Peter Rony, David Larsen and Jonathan Titus

The 8080A Bugbook:

Microcomputer Interfacing and Programming
 £6.85 Pb 672-21447-4 416 pages

Elmer Poe

Using the 6800 Microprocessor

£4.50 Pb 672-21512-8 176 pages

William Barder, Jr.

The Z-80 Microcomputer Handbook

£6.45 Pb 672-21500-4 304 pages

Prices and publication dates are correct at the time of going to press but may be subject to change without notice.

For our new microprocessing leaflet please write to Jean Walmisley at Prentice-Hall International, 66 Wood Lane End, Hemel Hempstead, Hertfordshire, H12 9RG, England.

Prentice-Hall  International

MICRO ASTROLOGY

MODERN TECHNOLOGY MEETS THE SECOND OLDEST PROFESSION

For most PCW readers astrology is a matter of Lucky Stars columns in newspapers and magazines: brief little forecasts that never seem to come true. Real astrology is much more complex. Instead of dividing the sky simplistically into twelve Zodiac signs, one for each month of birth, it takes into account the whole solar system at the exact moment of birth.

From this map of the heavens, it's possible for the astrologer to make a surprisingly detailed character assessment of the person involved: his temperament, inner emotional disposition, talents and hang-ups and even the state of his psyche at any moment in life.

To do this correctly, the astrologer must be both a mathematician and artist. Mathematics are required to calculate the exact positions of the Sun, Moon and planets at the time of birth; and artistry is needed to interpret these hieroglyphs and numbers into a sympathetic language which the client can understand.

Since astrologers, like most people, are more literate than numerate, the traditional way of calculating a horoscope has been made, over the centuries, as painless as possible. All they need do is look up tables of planetary motion, called ephemerides, and interpolate between one day's position and the next. Then they must find the angular separation between any pair of planets, and, again referring to tables, discover which degree of the Zodiac was rising above the eastern horizon.



Roger Elliot runs a computerised horoscope service from his Somerset manor house. Here he explains how the planets and computers go hand in hand.

The whole process takes half an hour, at most. Then they can become artists again.

Astrologers, as you can imagine, like to believe that their craft requires a great deal of intuition. And so, at the most exalted level, it does. But at an everyday level it is surprisingly logical. Astrological interpretation is really a series of equations: on the left side, a planetary pattern such as 'Mars in Capricorn square Venus in Libra', on the right side a description like 'His dynamism at work contrasts oddly with a sweet but lazy disposition in bed.'

It follows that not only the mathematics of astrology, but some of its artistry too, are amenable to computerisation.

Early efforts

All astrological textbooks contain basic descriptive paragraphs for the main planetary patterns. About 20 years ago, two separate enterprises made the move to computerisation. Astroflash, in Paris, provided a character study based on planets in Zodiac signs and houses: a total memory of not much more than 240 paragraphs, with each client receiving the 20 appropriate to his horoscope. In New York, Time-Pattern Inc devised a more searching analysis, introducing planetary aspects (ie, angles between planets) and trying to marry the various paragraphs together to make a more natural narrative.

I was the first astrologer in this country to put my name to computerised character studies and forecasts. That is, I wrote the necessary paragraphs while a professional programmer stitched them together on an IBM 370. I knew nothing about programming; he knew nothing about astrology; and the end-result lacked any subtlety.

There are three areas of complaint that can justifiably be made against these early efforts:

1. Mathematical accuracy

In my own case, we simply fed an abbreviated 20th-century ephemeris into memory: a highly inefficient use of man and machine.

2. Integrity of text

When a text is composed of disparate paragraphs, without any reference to each other, the most shocking contradictions can occur. A client, for example, can have two conflicting astrological factors: Sun in Gemini, let us say, and Moon in Capricorn. The human astrologer, writing his own report, can marry these factors into a balanced account, explaining how these factors can sometimes help and sometimes hinder each other. But a crude computerised report will blindly announce 'As a

Geminian you are lively, restless and fickle' and, in the next sentence, say 'With Moon in Capricorn you are stoical, cautious and conservative.'

3. Personal references

An individual astrologer will relate his report to the personal circumstances of his client. But in these early computerisations the only individual circumstance taken into account was sexual gender; reports for male clients were structured slightly differently from those intended for women.

Starlife project

By the start of 1978 I was aware of the first rumblings of the microprocessor revolution. The downturn of costs, together with the upturn of my own interest in computers, meant that, for a substantial but feasible capital outlay, I could buy and program my own equipment and run a horoscope service from my own home.

The time from conception of this idea to its birth as Starlife was, appropriately, nine months. In nine short months I sorted out my RAMs from my ROMs, learnt BASIC, bought computers, printers and ancillary machines such as guillotines and bursters, wrote two lengthy programs of about 34K each, and, not least, wrote the equivalent of three full-length novels as my basis for my astrological text. It proved to be an exhilarating, exhausting venture, after which I deserved a long vacation. But no sooner had I concluded my work as programmer and author than I had to transform myself instantly into data entry clerk, operator, binder and mail-boy, since I'd had no time to train anyone else to run the system!

For the response, via TV Times, was phenomenal. In the first week there were 2000 applications for birthday horoscopes, and to process these orders I had one Cromemco computer, one Tally printer and one Newbury VDU. True, a second computer arrived in a couple of months; and a second and third printer soon afterwards; but by April I had a backlog of 4000 angry, frustrated clients.



Business considerations

Everything is running smoothly now. But since many PCW readers may be thinking of tackling a similar entrepreneurial venture at some time, in some field if not astrology itself, it's worth analysing my experiences with some care.

If you are thinking of setting up any computerised cottage industry, bear these points in mind.

Equipment

There's a minimum investment below which you cannot stray. As the actress said, don't do a man-sized job with a boy's set of tools. Not only are cheap microcomputers too slow and small and unreliable for the task, but they prevent adequate future expansion. The equipment I chose — wisely, looking back — was a Cromemco System Three computer, with 64K core memory and 1MB of disc memory; and Tally 1612 printers, picked for their reasonable throughput (about 120 cps) allied with their wide range of expanded matrix typefaces. The 7 x 7 half-matrix typeface lacks descenders true enough; but the end-result on the page is stylish and professional. In common with many Tally users, I have had a number of stoppages caused, apparently, by some kind of tarnishing within the RAMs through over-use; but Tally have done many modifications and seem to have solved the problem now. With the Cromemco cards I've had virtually no trouble at all; but the discs have, like medieval heretics, frequently passed into a state of error. Sometimes this has been bad luck: components failing quicker than they should. More often the fault has been my own dusty, french-windowed office, full of Somerset notes. If I were buying afresh, I would pick the new Cromemco Hard-Disc systems, for their promised reliability and speed.

The Starlife programs

These split into two groups: those dealing with data input and the main Birthday Horoscope program which creates the actual reports. Let's take them in order:

1. Data input

Each application must be processed in two ways: temporarily into an ORDERS file (holding 100 at a time) and

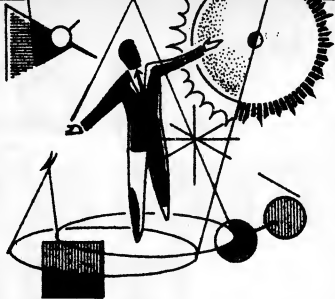

permanently into my alphabetical CLIENTS files.

The first data to be entered are surname, date, month and year of birth. Armed with this information, the appropriate CLIENT file is searched to see whether this is a new or existing customer. Additional data is then entered: birthplace and birth-time (with summer time automatically deducted) and the computer picking a random birth-time if the actual time is unknown; first name; sex; marital status; address; type of report needed; and payment. There are various fail-safe routines for trapping and changing input errors; and the data is then stored in ORDERS and the correct CLIENT files.

2. Ancillary files

There are various files supporting this program. Latitudes and longitudes of every place-name in the British Isles are filed in the 26 LATLONG files. Time-zones are extremely complicated, especially in the US where adjacent counties in the same state might — or might not — adopt summer time in a particular year. Various TIME files calculate these adjustments for most countries in the world. Most important of all are the CLIENT files, 575 of them grouped alphabetically on 36 discs which can accept a maximum 50,000 customers. The first four letters of a client's surname establish which file is the correct one. (Problem: the MACs, JOHNsons and SMITHs now take quite a few seconds to search.) With a hard-disc system there would be none of this swapping and changing of discs, of course; on the

other hand, this disc-handling does add variety to the operator's routine and prevents, I think, errors through boredom. As it is, we have an average error-rate of 2%.

There is no back-up for these 36 discs. (*What! Ed.*) My Verbatim 8" floppies have never let me down, after a year's operation.

Birthday horoscope

This is the most complex astrological word-processing program ever written. It generates a 10-page report covering the next 12 months of the client's life. The first half deals with the broad trends: your overall attitude to life in the coming year, how the world will treat you, and how you will fare at home and work, in love and friendship, in health and finances. The second half picks out the key dates in the coming year, giving some 90 precise predictions.

The text is composed of about 136 different paragraphs, chosen from a total data-base of about 2,500 different paragraphs. The chance of receiving the same report as another client is virtually nil; you would need to be born within five minutes of each other, and still be living in the same town, and to apply for your horoscopes on the same day, for this to happen.

A Birthday Horoscope is personal, in the sense that it's based on a detailed analysis of your individual birth-chart, and impersonal in the sense that nothing in the report is personally written for you alone. To give each report

"The cheapest most advanced business Microcomputer"

says Michael Korns of Computhink



ACT series 800 from only... **£19.45 p.w.**

*5 year lease. Shorter terms available.

The next generation computer system built in California by Computhink and backed by Britain's leading computing company, ACT.

The ACT Series 800 features lightning fast processing capabilities and unequalled data retrieval speed. It is upwardly compatible with the PET.

In addition to brilliant High Resolution Graphics the ACT Series 800 has the most advanced full screen data entry and editing capabilities ever made available on a micro-computer.

Nebula fully integrated software packages written in Britain by ACT include Sales Ledger and Invoicing, Purchase Ledger, Payroll, Stock Control and Word Processing. Plus over fifty more program titles.

ACT 808 with 800,000 characters of on-line disk storage, **£3,950 + VAT.**

ACT 824 with 2,400,000 characters of on-line disk storage, **£4,950 + VAT.**

Prices correct at time of going to press

PET is the trademark of Commodore

ACT series 800
Complete the coupon for full details and the name of your nearest dealer who can arrange an immediate demonstration.

My Name _____

My Address _____

Tel: _____

ACT

MICROSYSTEMS

*total
Computing*

Radcliffe House,
66-68 Hagley Road,
Edgbaston,
Birmingham B16 8PF.
Tel: 021-455 8686
Telex: 339396

more of a personal touch, there are numerous references inserted into the text: your first name, your age, your place of birth, your marital status and so forth. Certainly this style — to say nothing of the content — seems to be successful, for out of 10,000 clients in the first year of operation only seven have asked for their money back.

The flow-chart of this program shows how detailed is the mathematical analysis of the horoscope. First the program calculates the position — to the exact second of arc — of the Sun's geocentric longitude at your moment of birth. This is done using formulae, not an ephemeris, taking into account all the gravitational perturbations within the solar system. Then it works out the moment of solar return, when the Sun returns to this same position in the sky in 1980, and calculates all the remaining planetary positions for the same time. This is the solar return chart.

This chart is believed to resonate at different frequencies for different people, and so it's turned into your Harmonic Year chart by multiplying all factors by your age. Then the computer works out the positions of all planetary midpoints — that is, halfway points of the angles of separation — and the angles between these midpoints and the Sun.

Are you still with me? The next step is discovering the harmonic content of each of these angles: the frequency at which it vibrates, so to speak. Once this is known, the computer selects at random which of two similar paragraphs will be printed.

To give an example: let's say that in your 1980 harmonic year chart Venus is at 140 degrees and Pluto at 190 degrees. So their midpoint is 165 degrees. If the Sun is at 120 degrees, the angular separation is 45 degrees, which means that it vibrates on the 8th harmonic (360 degrees, of the sky divided by 45). In disc memory there's a file called HARMONIC. 35 corresponding to the Venus-Pluto midpoint, which contains 24 records — two for each of the twelve possible harmonics at which this angle can vibrate! So the program picks one of the two relevant records, and prints it.

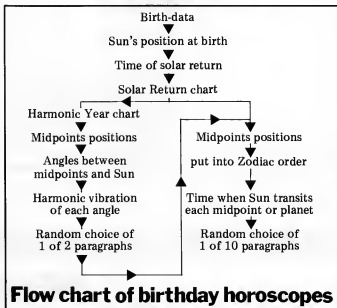

That takes care of the first half of the report. For the remainder, the program returns to the original solar return chart and calculates all its 78 midpoints, sorting them in anti-clockwise order from the Sun's position. It then works out when, in the course of the next 12 months, the Sun moving at variable speed through the geocentric Zodiac forms a transit with each midpoint and planet in turn. For each transit there's a set of 10 similar paragraphs, one of which is randomly chosen for inclusion in the report.

This program fulfils two important objectives: first, it produces a standard-sized report for each client, ensuring value for money (for the snag with other forms of astrological prediction is that they give a bumper crop of forecasts one year and

perhaps a dearth the next); and secondly, it is perpetual, as valid in 100 years' time as it is today. If any religious PCW readers wish to know the prospects in 1980 for the Living Christ, Starlife can tell you — provided, of course, that you supply the correct birth-data.

Future prospects

Although I'm proud of Birthday Horoscope, I recognise its short-comings. Despite its intricacy, it remains a 'painting-by-pictures' report. The program, when printing a paragraph, cannot relate it to any other paragraph.

So the next step must be to program the computer to weigh and consider each astrological factor in the light of other factors. In a character analysis program

that I'm writing now, the computer will scan the whole chart and give it a label or nickname: a summary of its salient characteristics. It might be 'Lucky Spiv' or 'Melancholy Scientist' or 'Shy Do-gooder'. It will then stitch together the appropriate sentences in a way that suits the person involved.

The aim of all astrological program design should be to reduce the data-base whilst increasing the flexibility. An example: you need 12 paragraphs to cover the Sun in each of the 12 signs, and another 12 for the Moon in each of the signs. But 144 are needed to cover the Sun-Moon combinations and 1728 to cover the Sun-Moon-Ascendant permutations.

If, on the other hand, you have a smaller number of sentences, or parts of sentences, and marry them together with ingenuity, you can produce a much more individual report. Shakespeare, after all, had a data-base of 30,000 words; he just put them together in such idiosyncratic ways.

Starlife software

Software, suitable for 8K and 16K PETs, Apples or TRS-80s, is available on cassette or 5" disc. With this package you can generate birth-charts, solar and lunar returns, transits, progressions and synastry charts, together with aspects, midpoints and harmonics. Prices range from £15 to £25.

If you are keen to develop your own programs in astrology, you should get hold of copies of Matrix magazine from 1041 North Main Street, Ann Arbor, Michigan 48104, USA. It's a quarterly, and six have been issued so far. They are packed with invaluable advice, formulae, short cuts and programs. They cost \$10.00 each, airmail. The best approach, now that there are no currency restrictions, is to mail \$20 or \$30 in notes to Michael Erlwine at that address, and he lets you know when you owe more.

Birthday horoscopes (£4.80 — send date, place and time of birth) — and software catalogues (£1.00) are available from Starlife, Cossington, BRIDGWATER, Somerset.

SUBSCRIPTIONS BINDERS KEEPERS LOSERS WEEPERS

Less than 2 years ago PCW became the first magazine in Europe to deal exclusively with the home and business use of Personal Computers. It has been an unqualified success. The current subscription list stands at well over 3,000, with a staggering 70% renewal rate! PCW reader loyalty is already a byword in the publishing business. We aim to keep it that way. So if you are having difficulty in obtaining PCW at your newsagent, why not take out a subscription and have the magazine mailed to you direct?

Half the people you meet today are not preoccupied with pollution, perversion or persecution. It's worse than that — they've lost a copy or two of PCW and don't know where to find replacements.

So keep your copies of PCW in a beautiful bright blue binder. £2.95 worth of smart security. Just check the coupon at the foot of the page.

Personal Computer World

UK Subscriptions: £8.00
USA Subscriptions: \$ 20.00
Subscriptions elsewhere: £9.80
Binders: £2.95
Please send me the next 12 issues of PCW
Please send me PCW Binders

NAME _____

ADDRESS _____

(Block capitals please)

I enclose cheque/P.O. for £ _____ made payable to
SportsScene Publishers Ltd.
Send coupon to PCW (Subscriptions), 14 Rathbone
Place, London W1P 1DE. Allow at least 14 days for
processing.

PET, APPLE II, ALPHA MICRO, BONDAIN BOOK-KEEPER AND NOW THE PORTABLE BRAIN FROM SHARP



- Z-80 based CPU
- 4K bytes monitor ROM
- Internal memory expansion to 48K bytes of RAM
- 14K extended basic (occupies 14K bytes of RAM)
- 10 in. video display unit — 40 characters x 25 lines display
- 80 x 50 high resolution graphics
- 78 key ASCII keyboard alphabet (capital and small) plus graphics
- Built-in music function
- Fast reliable cassette with tape counter 1200 bits/sec
- 50 pin universal BUS connector for system expansion printers, floppy discs etc.

Head Office:
Sumlock-Anita House
15 Clerkenwell Close
London EC1R 0AA.
Tel: 01-253 2447/8
Telex: 299844

Also at
Cannon Street Station
London EC4

SUMLOCK



BONDAIN

PCW SURVEY-THE PRIZEWINNERS

At least 1,957 people will hardly need reminding that back in our November 1979 issue, not only did we include the first Reader Survey of the new "regime" — we also promised to give away to the sender of the first questionnaire out of the bag, a really exciting and valuable "star prize" — a Sharp MZ-80K microcomputer, very kindly donated to us by Sharp UK.

As promised, on 10th December last, Sharp's Paul Streeter drew the winning entry — plus another 25 runners-up, who will all receive a free year's subscription to PCW.

Why 1,957 people...? Well, that's the number of questionnaires returned, as of December 10th. As magazine surveys go, such a return ranks very high indeed, and entirely apart from the fact that the information gained is already starting to prove most valuable, we've had quite a few chuckles over some of the "comments" concerning the Age/Name blunder on Question 1!

To quickly put 1,956 readers out of their misery, the winner is: *Terry Rigby*, a TV Transmission Engineer from East Sheen in London. He received



Paul Streeter congratulates Terry Rigby on winning his Sharp MZ-80K — and a pat on the back from Mike Sterland.

his prize from Paul Streeter at a ceremony that took place at Personal Computers Limited, in London's Bishopsgate on December 21st. PCL's Mike Sterland generously upped the 24K Sharp to full size and he also gave Terry a year's free guarantee on the

machine. Total value £850.

The 25 subscription winners are: Clive Crocker of Pinner in Middlesex; R.A. Du Boisson of Stretford in Lancashire; John Hyde of Frimley in Surrey; "no name" of East Horsley in Surrey; Andrew Thompson of Cottingham, N. Humberside; M. E. Morrice of Rugby in Warwickshire; D. I. Smith of Urmston in Lancashire; M. J. Parker of Letchworth in Hertfordshire; R. Wilson of Cirencester in Gloucestershire; John Kirk of Rothwell in Northamptonshire; Mr P. A. Varnes of Wigan in Lancashire; Bill Oliver of South Harrow in Middlesex; "no name" of Andover in Hampshire; David Akerman of Dagenham in Essex; N. W. Edgerton of Hove in Sussex; Mr G. R. Prett of Caversham in Berkshire; W. Flavell of Crawley in Sussex; Nigel Cook of Wickham; B. S. T. Marriott of Slough in Berkshire; Jerome Perkins of London SE8; John Lee of Southwell in Nottinghamshire; G. F. Clarke of Chesham in Warwickshire; S. J. Evans of London SE19; "no name" of Waterloo in Hampshire.

A SOUND INVESTMENT.

MP 12 and MP 15 Microprocessor Cassettes



When you record on cheap cassettes you run a high risk of program failure, dropout errors and excessive headwear.

Saving pennies on an unsuitable cassette could turn out to be very costly. To make a long life, high quality microprocessor cassette needs both tape and cassette mechanism to operate together in harmony.

Backing up the microprocessor cassette technology is a background of more than 10 years of experience within the Group on the manufacture of computer tape, memory discs and cartridges. Pyral is one of Europe's foremost manufacturers of magnetic digital recording media.

The perfect match of cassette body and tape.

For further information on the
Microprocessor cassette and other
Pyral products, send to:

Sales office: PYRAL MAGNETICS LTD, COURTLANDS ROAD, EASTBOURNE, SUSSEX. Tel: (0323) 638965 Telex: 877123

CHECKOUT

VECTOR GRAPHIC FLASHWRITER II

There are really only two ways to convey text (or graphics symbols) to a VDU screen from a computer.

Either characters are transmitted serially from the computer to a terminal unit, which then orders them on the screen according to their position in the sequence, paying due attention to any embedded formatting instructions; or, the computer directly places each character in a memory location which corresponds, via a one-to-one hardware mapping to a screen location. This second method, known as "memory mapping", is implemented by the "Flashwriter II" video board, manufactured by Vector Graphic Inc. Andrew M Stephenson reviews it.

Features

The noteworthy features of the Flashwriter II are:

1. Flicker-free display of 80 characters on each of 24 lines, consecutively addressed from a choice of starting locations.
2. S-100 bus compatible.
3. Non-interlaced pseudo-US frame standard; both composite video and direct-drive outputs available.
4. Re-programmable font of symbols: 128 supplied; 256 possible. Full ASCII set with true descenders supplied, plus graphics in "control" code area.
5. High bit (bit 7) sets inverse video and/or reduced intensity; or it helps select 1-of-256 characters.
6. 4MHz addressing, with "waits".
7. On-board parallel keyboard port.
8. Socket for optional ROM, with optional "Jump-on-power-up".

Availability

At least three stockists of the Flashwriter II regularly advertise in PCW. Currently, Almarc say that it should be available either ex-stock of at 6-8 weeks' notice, at around £230. Kit versions are not made.

The board was designed to interwork with the Vector Graphic "mindless terminal", which houses both keyboard and direct-drive monitor. As the terminal is not sold on its own, it must be ordered with the board, in which case the appropriate connecting cables will also be supplied. Some sources will happily sell the board alone, others are reluctant, so ask.

Compatibility

Nominally an S-100 unit, the Flashwriter II does not appear to conform to the new IEEE specification. Board buffering has not been fitted, but it is probably safe enough to assume a single, normal TTL load/source per line. All three power rails are needed: +8v (@ 910mA), +16v (@ 54mA), -16v (@ 31mA).

My board is Revision 2, dated 7 February 1979. Revision 1 of the manual was 30 January 1979, so obviously this is a product which has been evolving rapidly. Whether these frequent revisions were merely improvements, or were bughunts, I cannot say. My board certainly seems free of faults. The basic design derives from an earlier 64 character by 16 line VDU board and is very straightforward.

An important compatibility consideration is the usefulness of the supportive documentation, and in this respect the Flashwriter II is acceptably well served by a loose-leaf (US 3-hole punched) manual of 19 text sides plus diagrams of the supplied character font, the circuit, and the component layout.

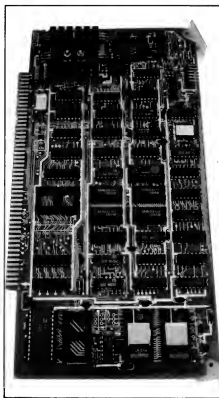

On the whole, the manual (Revision 3, dated 29 March 1979) is clearly and informatively written, though at times it seems uncertain whether it is being read by an expert or a "box operator". Presentation and style are clean, the diagrams uncluttered, the printing good.

My main complaints would be that, although the circuit diagram shows all components and their values, and identifies the important waveforms, enough component numbers are missing to be a nuisance and some S-100 edge connectors are repeated with no indication of the fact, thereby making circuit tracing needlessly difficult. There are also at least three mistakes in it. However, these are slight defects in otherwise helpful documentation.

Construction

The standard is good, with a double-sided glass fibre p.c. board that has plated-through holes and solder masking, and gold plating on the S-100 connector. Video output is through a 6-pin Molex connector, for which a plug kit is supplied. For those with mainframes of the correct dimensions, removal of the board is assisted by a pair of corner levers.

Apart from the odd IC (which may have been in short supply at the time of mass assembly) sockets have only been fitted where they are essential, such as under the two character ROMs, the key-

board port, and the spare ROM.

Several options have to be selected by cutting PCB tracks and linking others. Competent workmen should encounter few difficulties here.

TheVDU

To the CPU and the programmer, the VDU board "looks" like a 2K block of 4MHz RAM, of which the lower 1920 addresses match screen locations running across from the top left-hand corner, down the screen in the conventional reading pattern, with consecutive addressing throughout (i.e. second line, first character, is the eighty-first address). Board origin is supplied as D000 but may be set to any 2K boundary from C000 upwards. The top 128 bytes are "spare" and may be used as the programmer prefers.

The display is beautifully steady (but see "Tips", later) and, completely free of update-flicker; that's because CPU access is restricted to the inter-line blanking period. As a result, the CPU may be forced to wait (using the "PRDY" line [pin 72]) for anything up to 46 microseconds. In practice, this delay will only bother the most demanding users. For example, a 2.5MHz Z80 should be able to perform an average of three "LDIR" cycles per screen line period, which means a complete screen re-write would take about 44ms. A 4MHz Z80 could do much better. Delays can occur during both "write" and "read" operations, including those involving the top 128 bytes.

The empty on-board ROM socket may be strapped for 2708 or 2716, with the same choice of base addresses as the VDU. If the "Jump-on-power-up" option is selected, pulsing the "POC" line (pin 99) will enable the ROM and can also (if strapped) force the "PHANTOM" line (pin 67) low until the ROM is addressed. Sadly, if the user's system does not use the "PHANTOM" line, the Flashwriter II's "Jump-on-power-up" option could be tricky to set up correctly, so this feature would appear to be of doubtful value. Thankfully, only two NAND gates have been sacrificed to it.

The board is also capable of generating "MWRITE" (pin 68) from "PWR" (pin 77) and "SOUT" (pin 45).

Video Output

Both composite video and direct drive monitors are catered for. Line standard is pseudo-US, that is, vertical scan rate is 59.92Hz; there are 262 lines per scan, the scans not being interlaced.

The composite video signal measured at the output of my board is shown in Fig. 1. Voltage levels are not standard but good results were obtained on a Ceedata 1230 GHB monitor having a bandwidth of 10-12MHz. The 4 micro

second line sync pulse in the inter-line blanking period can be repositioned by an on board trimpot, sliding the displayed block of text left/right across the screen.

The direct drive signals available are: an approximately 4 micro second positive "horizontal" pulse from a TTL gate; an approximately 128 micro second negative "vertical" sync pulse from a TTL gate (option; positive pulse; positive "video" from two 7406 gates with a 150 ohm pull-up resistor).

Unfortunately, there is no true standard for direct drive monitors, so various manufacturers' units require all sorts of pulse widths and phases. The Flashwriter II is meant to drive a Ball Brothers TV120, but mine is being used successfully on a Digivision MW1212 having a nominally incompatible set of sync pulse requirements. In fact, only slight alteration of the VDU board was required (the addition of a 680pF capacitor).

Varying the displayed characters

As supplied, the Flashwriter II will display a full set of ASCII characters, white-on-black, including "DEL" (7F) which shows as a fine-grain chequer-board. "Control" codes show as graphics, as in Fig. 2: cells 'a'-'e' reflect the states of bits 0-4 ("1"="on"); and if bit 7 is set, 'a'-'e' are inverted and cell 'f' is set "on".

In general, if bit 7 is set, inverse video is specified for that screen location. Optionally, reduced intensity may be selected (the user fits a resistor whose value defines the intensity), simultaneously or as an alternative.

The two character PROMs define the entire location field, 8 dots wide by 10 lines high; one handles the top 8 lines, the other the lower 2 lines (see Fig. 2). Most of the supplied characters lie within a field of 5 dots by 7 lines, plus 2 lines for descenders. If the user wishes, the set of 128 symbols can be expanded to 256, by substituting a 2716 and at the expense of inverse video and reduced intensity (unless, of course, these features are to be used simultaneously with the "upper" 128 symbols in the new set).

Keyboard

The latched keyboard port can respond to either positive or negative going strobe edges. Port addresses are selectable: 2n (status) and 2n+1 (data), where n=97. If desired, an interrupt on line "PINT" (pin 73) may be generated when data is available also; the status byte shows READY on bit 6 and READY on bit 0. Bit 5 of the status byte is "0" during the 22-line vertical blanking period.

Tips

Here are a few tips drawn from personal experience:

Without a doubt, it is a very poor sort of direct drive monitor which will not give a display superior to that obtainable from a comparably priced composite video unit. With a dot rate (the rate at which screen character elements change brightness level) of 14.318MHz, the Flashwriter II needs a monitor of about that bandwidth. Reasonably priced composite video units can usually offer 10MHz or so, guaranteed. Whilst this will permit the resolu-

tion of most details, it is less than adequate if the screen must be looked at for very long. By contrast, even an average direct drive monitor has a bandwidth in excess of 20MHz.

Having bought a good VDU board and a matching monitor, too many users then link the two with inferior cable. This is silly; don't just take it for granted that cable, sockets, plugs or joints are up to scratch - check them. Noticeable improvements can be produced with this simple precaution.

If the display wobbles or ripples, check for stray magnetic fields, such as from power supply transformers. Monitors powered by 50Hz mains but displaying at 60Hz field rates are especially sensitive to this problem, although a separation between mainframe (metal cased) and monitor of a couple of feet is usually sufficient.

Finally, the good news: the Flashwriter II seems quite happy with unmodified mainframe supply rails, demanding no special precautions in that area.

Optional 2K systems monitor

(Note: this section was written purely from Vector Graphic literature kindly supplied by Almarc Data Systems Ltd. Therefore, the accuracy of remarks made here are dependent entirely upon the accuracy with which I have interpreted that literature. However, in common with the Flashwriter II manual, it's well written and seems unambiguous.)

Vector Graphic also sell a 2K Extended Systems Monitor for the Z80. Release 4.0 (dated 15 October 1979) is available on two 2708s at around £25 and is aimed specifically at the Flashwriter II in a Vector Graphic system. As such, it embodies several commands which are system specific jumps to strange addresses, for example - and expects a keyboard on ports 0 and 1. No one can damn it for that. However, we shall see that it also embodies enough oddities, and even defects (in my considered opinion), to give any wise potential purchaser reason to pause.

Without these idiosyncracies, it would be a useful addition to the system software, for it has several fine features such as a versatile video driver, two powerful memory test commands, and a useful memory examine/change command. In all, there are some two dozen commands. Unfortunately, the principle of *crucial error* cannot be allowed to prevail, for Vector Graphic has filled no fewer than four sides of their Flashwriter II manual with attractive publicity for their Monitor, so an overt warning here seems fair.

Several of the Monitor commands exhibit a curiously half-engineered appearance, as if the designer(s) failed to think through the logic of their functions fully. For example, there are separate commands to find one and two bytes, and separate commands for wide and narrow-screen memory dumps; these are but two examples of commands that could easily have been rationalised.

Then, the method of entering hex values is ridiculously clumsy. If, say, four characters are needed, either exactly four must be given, with no chance of error recovery save by restating the command, or "SPACE" must be hit to

signify leading zeroes; other Monitors are content to accept the last four characters entered, and use "SPACE" to signify completion of the entry, leading zeroes always being assumed, by default.

But the real villain of the piece is the Block Move command. If a block of bytes is moved upward through memory into an area which partially overlaps the original area, the overlapped area will be corrupted; yet this glaring fault is actually claimed by the Monitor manual to be a useful feature.

To its credit, the Monitor does take such sensible precautions as converting lower case letters to upper case, and ignoring meaningless entries. All is by no means lost. However, I could not with a clear conscience recommend this Monitor to anyone, except those desperate for a video driver (a nice piece of programming, as I have said); owning a Vector Graphic system might sway the decision, otherwise, one should wait for future revisions.

Verdict

Let's be quite clear about one thing; whilst I have little love for the Extended Systems Monitor, Release 4.0, I have no hesitation in recommending the Flashwriter II video board. Some users may find that a couple of options clash with their systems, but as a straight video board my unit has given next to no trouble at all. It is not for the casual user, perhaps (the need for a good quality monitor is a complication) but, as an adjunct to my "WordStar"-based word processor for the past six weeks, it has proved entirely satisfactory. Besides, it appears at present to be the only realistically priced 80x24 memory mapped S-100 VDU board on the British market.

Figure 1: measured composite video signal from VDU (inter-line period).

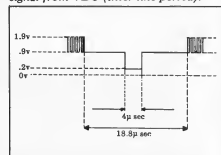
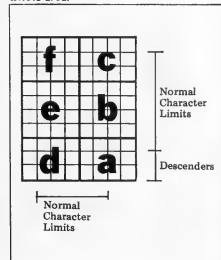

Figure 2: supplied character format; graphics use cells 'a'-'f'; "DEL" fills whole area.



comart

... the specialists



The complete range of North Star computer products in both kit and assembled form is offered by Comart: The Horizon computer, the Microdisk System, memory and floating point arithmetic board. And, Comart being S100 specialists, other items from our computer catalogue may be easily added to meet your requirements.

Teaching, Research, Engineering and Commerce each field has applications where this state-of-the-art technology provides cost effective processing of immediate benefit.

Comart quality. Each assembled module is final-tested by our own engineers. Take delivery of a computer system - plug in a wide variety of peripherals and use it.

Attractive prices, good delivery and a choice of Comart's factory repair or on-site service with a Computer Field Maintenance contract make the acquisition of a Comart computer a safe decision.

Find out more - ask us for the Comart catalogue of Computers.

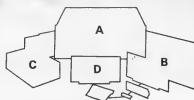

The North Star dual drive double-density Horizon computer **A** together with a typical kit product **B**, the Microdisk system drive **C** and hardware floating point board **D**.

Contact us direct or call your nearest Comart dealer

CAMBRIDGE
CAMBRIDGE
LEEDS
LONDON
LUTON
MANCHESTER
NEWBURY
NEWPORT
NOTTINGHAM
SHEFFIELD
SOUTHAMPTON

CAMBRIDGE COMPUTER STORE, Cambridge G223N 6B155
MICROETS, Cambridge Sunny 10276 34244
THE BYTE SHOP, Harlow Essex Q1 554 2177
also at Tottenham Court Road London G8 636 0847
HOLDEN LIMITED, London (0532) 459459
also at Witney Oxon (0625) 629486
DIGITAL LIMITED, London W11 820 0905
SHERWOODS, Luton Bedfordshire (0582) 424851
MICROCOMPUTERMART, Manchester (061) 832 2269
also at Mill Park Leeds (0532) 788468
NEWBEAR COMPUTING STORE, Newbury Berks (0635) 30555
also at Stratford Chelms 101 491 2296
MICROMEDIA SYSTEMS, Newport Gwent (0693) 50528
COMPUTERLAND LIMITED, Nottingham (0662) 60576
also at Birmingham (021) 622 1149
Manchester 061 236 4737
Glasgow 041 532 1469
HALLAM COMPUTER SYSTEMS, Sheffield (0742) 663125
JITAN SYSTEMS LIMITED, Southampton (0703) 58740



comart specialists in microcomputers

Comart Ltd., P.O. Box 2, St. Neots, Huntingdon, Cambs, PE19 2AF. Tel: (0480) 215005 Telex: 32514

COMPUTER GAMES



AND THEN THERE WERE TWO

Chess Master, David Levy, continues his series of articles on the principles behind playing computer games with a study of the added difficulties involved in introducing a second player.

Two-person games

Two-Person games, such as chess, backgammon and draughts, are usually more interesting and challenging than one-person games, and it is to these that we shall be devoting most of our studies. The introduction of a second player creates manifold difficulties that do not exist in a one-person game, but fortunately for today's programmers these difficulties have been extensively analyzed in the computing literature and the problems are now rather well understood.

The two-person game tree

Game trees become more complex structures when an opponent appears on the scene. Let us consider a relatively simple game, noughts and crosses (tic-tac-toe to our American cousins), and examine how its tree will look after a move or two of look-ahead. We shall assume that "cross" moves first.

From the initial position there are three essentially different moves:

- 1) e (the centre)
 - 2) a, c, g and i (the corners)
 - 3) b, d, f and h (middle of the edges)
- On the first move, any of group (2) is equivalent to any other, since all four moves are merely reflections or rotations of each other. Similarly, within group (3) all moves are equivalent.

This technique of utilizing symmetry to reduce the magnitude of the problem is well worthwhile when programming a game that lends itself to a symmetrical analysis. By reducing the number of moves that need to be examined at any point in the tree you will be cutting execution time dramatically, because

the combinatorial effects of tree growth are enormous. The savings in time that can be achieved through using symmetry can be extremely valuable when improving the performance of the program by making its evaluation function more sophisticated (and slower).

If we so decide, our program can terminate its search of the tree after looking at each of its possible moves from the root. This is called a 1-ply search because the program only looks one "ply" deep. (The term "ply" is used to denote a single move by one player.) In order to decide which move to make, out of m_1 , m_2 and m_3 , the program will then apply its evaluation function to the three positions at the lower end of the tree (these

are called the terminal positions). Whichever position had the best score would then be assumed to be the most desirable position for the program, and the program would make the move leading to that position.

How should we set about designing our evaluation function? This is one of the fundamental problems in game playing programming because a good evaluation function will help the program to make good judgements, and hence to play well, even though the depth of look-ahead may be shallow. A poor function, on the other hand, might well result in poor play even with a deep and time consuming search of the game tree. It is therefore very much worthwhile putting some careful thought

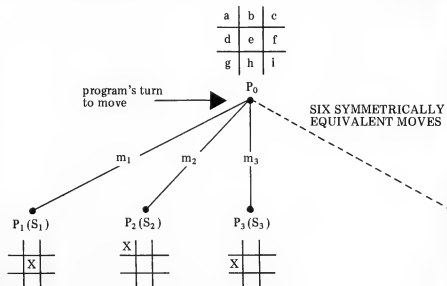

Figure 1

into the design of the evaluation function, and the following example should illustrate the type of thinking that is necessary.

The object of the game is to create a row of three of your own symbols. We shall call this a "3-row". The next most important thing is to prevent your opponent from making a 3-row, which means that he should not have a 2-row after you move (a 2-row has two symbols of one player and one empty space). Next most important is the creation of your own 2-rows; then it is important not to leave your opponent with 1-rows (one of his symbols and two empty spaces); and finally you should try to create your own 1-rows. All of these features could well be incorporated into a noughts and crosses evaluation function.

If we denote the number of cross's 3-rows by c_3 , the number of nought's 2-rows by n_2 , the number of cross's 2-rows by c_2 , the number of nought's 1-rows by n_1 , and the number of cross's 1-rows by c_1 , . . . then one measure of the merit of a position from cross's point of view would be:

$$c_3 \cdot n_2 + c_2 \cdot n_1 + c_1$$

but this measure has one obvious drawback. It does not allow for the fact that the term c_3 is more important than n_2 , which is more important than c_2 , and so on. This can be done by multiplying each of the terms in the evaluation function by some numerical weighting, in such a way that the weightings (hopefully) reflect the relative importance of each feature. The evaluation function then becomes $(k_3 \times c_3) \cdot (k_2 \times n_2) + (k_1 \times c_1) \cdot (k_1 \times n_1) + (k_1 \times c_1)$

where k_3, k_2, k_1 and k_1 are the numerical weightings. Since one c_3 is worth more than all the n_2 s in the world, i.e. a winning row is more important than any number of 2-rows, we can set k_3 to be some arbitrarily high number, say 128. By studying the game

for a few minutes it is possible to see that if one side has a 3-row, the other side may have at most two 2-rows, so to reflect the relative importance of one's own 3-rows and enemy 2-rows it is necessary to ensure that $k_3 > 2 \times k_2$. We can therefore try $k_3 = 63$. (If one side has a 3-row and his opponent two 2-rows, the opponent will not have any 1-rows to upset this scoring mechanism.)

If there are no 3-rows, but one side only has a 2-row, his opponent cannot have more than three 1-rows, as in the following situation.



So $k_2 > 2 \times k_1$ and $k_2 > 2 \times k_1$, and we can try $k_2 = 31, k_1 = 15$ and $k_1 = 7$. Remember that we can modify these values in the light of experience with the program, the values 128, 63, 31, 15 and 7 are merely our first estimates. Having made these estimates we should then ensure that the score for a noughts and crosses position will never cause an overflow, and we do this by setting up positions which will have the largest and smallest possible scores, and counting the number of 3-rows etc. in each. This is a very important part of evaluation function design, and I remember a chess programmer who could not understand why his program crashed whenever it was winning or losing by a great margin - he had forgotten to allow for the possibility of one side being two queens ahead and when that happened his evaluation calculations created an overflow.

If we now return to figure 1 we can see that each of the three possible first moves results in the creation of a different number of 1-rows. Applying

the evaluation function.

$$128 \times c_3 - 63 \times n_2 + 31 \times c_2 - 15 \times n_1 + 7 \times c_1$$

to the three positions P_1, P_2 and P_3 we find that in each case $c_3 = n_2 = c_2 = n_1 = 0$, and therefore:

$$S_1 = 128 \times 0 - 63 \times 0 + 31 \times 0 - 15 \times 0 + 7 \times 4 = 28$$

$$S_2 = 128 \times 0 - 63 \times 0 + 31 \times 0 - 15 \times 0 + 7 \times 3 = 21$$

$$S_3 = 128 \times 0 - 63 \times 0 + 31 \times 0 - 15 \times 0 + 7 \times 2 = 14$$

and S_1 is the most desirable of these scores so the program would make the move m_1 to reach position P_1 (i.e. it would play in the centre).

The 2-ply search

The 1-ply search is the simplest form of tree search in a two-person game, but it does not take into account the fact that once the program has made its move there is an opponent waiting to reply. It may be the case that a move which, superficially, looks strong, is seen to be an error when we look a little bit further into what may happen. The 2-ply search will "see" more than the 1-ply search and so moves made on the basis of a 2-ply search will be more accurate (provided that the evaluation function is not a disaster area). How can we take into account this extra dimension of the opponent's move?

Let us look at the same tree, grown one ply deeper, i.e. to a total depth of two ply - one move by the program and one move by its opponent.

If "cross" plays in the centre, "nought" has two essentially different replies, in a corner or on the middle of an edge (represented by positions P_{11} and P_{12} respectively). If "cross" makes his first move in a corner (P_2), "nought" will have five different reply moves ($m_{21} m_{22} m_{23} m_{24}$ and m_{25}) leading to positions $P_{21} P_{22} P_{23} P_{24}$ and P_{25} . After "cross" plays move m_3 , "nought" again has five replies. It is easy to see how the tree grows. In last month's example, the 8-puzzle, the

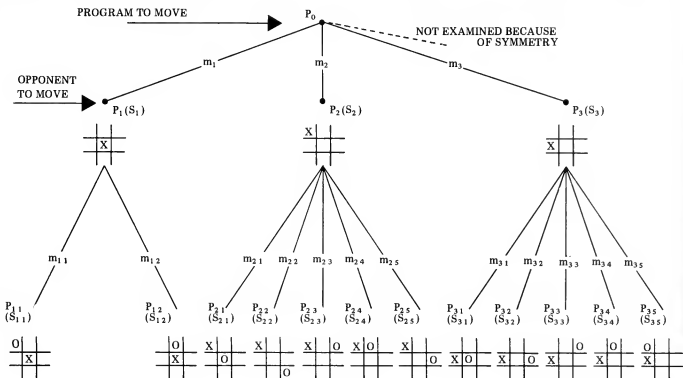

Figure 2

branching factor (number of branches from each position on the tree) was never more than three. Here it is more, even allowing for symmetry.

Let us consider how the program might analyze the situation. It uses its evaluation function to assign scores to the terminal nodes P_{11} and P_{12} . In each case $c_3 = n_2 = c_2 = 0$. In position P_{11} , $c_1 = 3$ and $n_1 = 2$. In position P_{12} , $c_1 = 3$ and $n_1 = 1$.

We now have:

$$S_{11} = (-15 \times 2) + (7 \times 3) = -9$$

$$S_{12} = (-15 \times 1) + (7 \times 3) = 6$$

This information indicates that if the program is sitting in position P_1 , with its opponent to move, its opponent may choose between moves m_{11} (leading to position P_{11} of value -9) and m_{12} (leading to position P_{12} of value 6). The program's opponent wants to minimize the score and so it would choose move m_{11} , for a score of -9, and so the real value of position P_1 , represented by S_1 , is this *backed-up* score of -9.

If we apply the evaluation function to positions $P_{21} \dots P_{25}$ we will get:

$$S_{21} = (-15 \times 3) + (7 \times 2) = -31$$

$$S_{22} = (-15 \times 2) + (7 \times 2) = -16$$

$$S_{23} = (-15 \times 2) + (7 \times 2) = -16$$

$$S_{24} = (-15 \times 1) + (7 \times 2) = -1$$

$$S_{25} = (-15 \times 2) + (7 \times 3) = -9$$

Wishing to minimize the score when making its move from P_2 , the program's opponent would choose move m_{21} , leading to position P_{21} and a score of -31.

Similarly, when applying the evaluation function to positions $P_{31} \dots P_{35}$, we get:

$$S_{31} = -38$$

$$S_{32} = -8$$

$$S_{33} = -31$$

$$S_{34} = -16$$

$$S_{35} = -23$$

so the program's opponent, when making its move from P_3 , would choose move m_{31} for a score of -38.

We now have the following situation. If the program makes move m_1 , its opponent, with best play, can achieve a score of -9. If the program plays m_2 then its opponent can achieve a score of -31. If the program plays m_3 then its opponent can score -38.

Just as the program's opponent wishes to minimize the score, so the program wishes to minimize the score. The program must now choose between m_1 (for -9), m_2 (for -31) and m_3 (for -38). Since the maximum of these three values is -9, the program will play move m_1 , and the backed-up score at the root of the tree will be -9. This represents the score that will be achieved with best play from both sides.

This procedure of choosing the maximum of the minimums... etc. is known, not surprisingly, as the minimax method of tree searching. It is an algorithm that finds the move which will be best, assuming correct play for both sides, provided that the evaluation function is reasonably accurate.

Memory requirements for a minimax search

One of the great advantages of the minimax type of search is that it is not necessary to retain the whole tree in

memory. In fact it is necessary to keep only one position at each level of look ahead, together with a certain amount of information about the moves from each of these positions. Let us see how this works for our 2-ply tree.

From the initial position P_0 , the program generates the first move for cross, to position P_1 . Before proceeding to the other moves that cross can make, the program generates the first reply move by nought, m_{11} , reaches position P_{11} and assigns it the score S_{11} (-9). This is the first terminal node to be evaluated, so the score of -9 represents the best score found so far and this is the score that is assigned to S_1 . Since P_1 is the first move at 1-ply to be examined, this score of -9 also represents the best score found so far at the 1-level, and this is the score assigned to S_0 .

The program now looks at P_{12} , which we sometimes refer to as the brother of P_{11} (and P_1 is father to both of them). The program determines the score S_{12} , compares this value (6) with the best score found so far at this level (-9) and finds the -9 preferable, so the scores S_1 and S_0 need not be adjusted at this stage. The program next looks for a brother to P_{11} , but finding none it goes back up the tree and looks for a brother to P_1 , which leads it to position P_2 and then to P_{21} . On the way down this part of the tree the program assigns to P_2 a score of -9, since this is the best that can be achieved so far. When looking at P_{21} the program finds a score of -31, which is better for the program's opponent than -9 and so S_2 is now set to -31.

Note that as this process continues, the brother nodes that have been examined in the past no longer serve any useful purpose and so they can be discarded. At the present point

in our search we no longer need the brother of P_2 that has already been examined (P_{11}), so P_1 and its successor nodes are not kept in the tree at this time. The tree, at this moment, comprises only P_0 , P_2 and P_{21} .

Having evaluated P_{21} we throw it away and look at P_{22} , which has a score of -16. The program's opponent would not prefer this to the -31 already discovered, and so no change is made to S_2 . The program discards P_{22} and replaces it with P_{23} for a score of -16, also of no value to the program's opponent, and this is replaced in turn with P_{24} and P_{25} which also produce no change in S_2 .

Since S_0 (-31) is less attractive for the program than the best score found so far (-9 at S_0), the score at P_2 is not backed-up. P_2 itself is discarded to make way for P_3 , and the same process continues, with the program looking in turn at the scores of $P_{31} \dots P_{35}$.

Task for the month

The evaluation function for noughts and crosses which we have been using in this example has five features. Try to devise evaluation functions with as few features as possible, for playing noughts and crosses with (a) a 2-ply search; and (b) a 3-ply search, and test your functions by writing a program to play the game using a minimax search. The fact that deeper search will sometimes compensate for a less powerful evaluation function may make it possible for you to reduce the number of features while still writing a program that can play perfectly. If you complete this task, or even if you do not, you might like to think of a way to make the search much faster. This will be the subject of next month's article.



Good heavens a floppy disc!

CALCULATOR CORNER

This month Dick Pountain reviews two packages of software that are commercially available for use on programmable calculators.

Master pack

I have now received a production sample of the Master Pack set of programs for the Casio 501/502P briefly mentioned in an earlier Corner.

The Pack consists of a 54 page comb-bound User Manual and a cassette; it sells at a recommended price of £17.95.

The programs on the cassette consist of 15 originals, followed by the 120 odd Casio Program Library programs in the order printed. Incidentally it has come to my notice that a few early samples of the calculator were supplied with an inferior, earlier edition, program library which contains fewer programs and in a different order (which would make its use with the Master Pack very difficult indeed). The way to tell if you have this edition is that the first program is titled Mathematics O. In the later, superior, edition the first program is Mathematics I.

The Master Pack programs are identified only by spoken introduction (all have the same file no. 100) and the order in which they appear in the User Manual/Program Library. Users with a recorder which has a tape counter could make up their own counter reading index, but in any case it's recommended that frequently used programs be transcribed to a working cassette and the Pack kept as a master copy, to avoid damage.

The User Manual contains sections on basic and advanced programming which, though shorter than the Casio Manual, are more clearly and logically written, and will not insult the intelligence of anyone who has a minimal familiarity with programming. They do not include a key-by-key guide to the calculator so the absolute novice would best use them in conjunction with the Casio Manual.

The advanced section covers loops, labels and subroutines well, and goes into indirect operations in far more depth than the

manufacturer's manual. It concludes with some original programming techniques for creating extra labels and program titles, data scrolling and prompts and display formatting which will be useful to "intermediate" standard users.

The manual also contains full documentation for the 15 original programs, and concludes with a key-code index and an explanation of telephone transmission of programs using a dictaphone type telephone pick up.

Of the 15 original programs included, 7 are games such as Lunar Lander, Bomber Pilot and Number Patience. They are all well thought out and make maximum use of the Casio's superior display capabilities. Of the rest, 7 are "utility" programs such as Reaction Timer, Price Comparator, Diet Calculator, and there's Electronic Scoreboard which replaces chips or money in card and board games such as Monopoly. The final program is the most interesting. It's a set of subroutines for data packing, which means creating a virtual array of addressable memories with less than 12 digit capacity. For instance the 502 can be given the equivalent of 200 independently addressable single digit memories, or 100 two-digit memories. The data packing routines may be used manually or incorporated into user's programs. An obvious application is in statistical analysis of certain types and the routines are written so as to leave the statistics registers (M7, 8 and 9) free for this purpose. Some of the games use the data-packing technique to provide a 10 x 10 playing field which may be viewed by scrolling it line-by-line up the display. To this end a further routine is incorporated which generates a key-pad compass cursor to "steer" a target digit through the background field of 1s.

All things considered it's a useful package, not so much for the hobbyist who will probably write his own material, but for the professional user who needs

frequent recourse to the Program Library material. It's rather a pity Casio didn't supply such a package themselves.

The pack should now be available in shops or from: Premier Publications, 12 Kingscote Road, Addiscombe, Croydon, Surrey.

Broadwater economics simulations

These 5 programs (with 6 more to follow in the Spring of 1980) are designed as a teaching aid for A-level economics students and are the work of Graham Addis, an economics teacher.

The programs are written for Texas TI 58/59, Casio 501/502P and in BASIC, all three listings being supplied together with teachers and students notes and an explanation of the economics used, in booklet form. They may also be obtained on cassette or magnetic card.

Intended for use by a group of students, they demonstrate the dynamic behaviour of various Keynesian economic parameters (such as for instance the investment multiplier), without the need for the tedious arithmetical calculations which often can be an obstacle to the understanding of complex systems.

However, three of the programs — Figsaw, Poligam and Macropol — are simulations of the operation (massively simplified of course) of a whole economy, and as such are fascinating, even to the economic illiterate such as myself.

I found Macropol in particular quite engrossing. This simulates an island economy with no foreign trade. You are placed in the position of Chancellor of the Exchequer and by manipulating expenditure and direct taxation, you attempt to control the economy, year by year. At each year end, you see the results of your "policies" on unemployment, inflation, investment, growth,

consumption, budget deficit, income and stock disinvestment; then you try to do better next year! Although the model used reduces the economic relationships to a mere 9 equations, it nevertheless has sufficient realism to exhibit the sorts of economic fluctuation of which newspaper headlines have been made for the last 10 years. Although our present Monetarist Mentors would disagree, it seems likely that the sort of Keynesian theory illustrated in these models still provides the best description available of the workings of the modern industrial economy; certainly since 1945 it has significantly shaped the Institutions of the economic world in which we live.

Playing with Macropol for a few hours certainly gave me a small insight into the frighteningly sensitive and unstable nature of the feedback systems which operate in the economy, and perhaps even gave me a little more sympathy for those much maligned administrators whose task is to tinker with it.

I'm sure that a very enlightening and demanding game could be contrived using Macropol where various players represent different "parties" and take turns to have five years in power, being judged by the "electorate" on their performance.

The 6 programs to be added later will all deal with the theory of the individual firm, with pricing, profitability and competition.

These programs are well presented, very reasonably priced at £1.50 each and will, I'm certain, be well received in the educational quarters at which they are aimed. It would be nice if they found some interest outside schools too; after all, economics affects all of us and certainly a good deal more than Allen Invasions or Lunar Landings. All inquiries to: Broadwater Economics Simulations, 24 Hill Barn Lane, Worthing, W. Sussex.

ON THE LINE

Breaking down the barriers to personal computer networks — David Hebditch brings us up-to-date on his "ongoing" tussle with the PO, by way of further extracts from the correspondence.

The Post Office connection -Part 2



14th May, 1979 Letter to the Post Office.

Perhaps I could remind you that we are suggesting that users of personal computers be allowed to transmit over the public telephone network without type approval if the following conditions are met:

1 That only acoustic couplers should be used.

2 That the acoustic coupler employed should be fully type approved by the Post Office.

3 That any personal computer owner employing acoustic couplers as a means of transmitting data on the public network should register such use with their local telephone manager.

We look forward to hearing from you.

8th June 1979 Reply received from the Post Office.

My comments on your letter of the 14th February, are as follows:

1 I accept that in the circumstances outlined in your letter of 5th October, acoustically coupled modems could be required at both ends of a data transmission link and as such there are no policy objections provided that both modems are used itinerantly. I would hope, however, that users were aware that acoustic couplers are sensitive to background noise and therefore, if used at both ends of the link, will suffer additional transmission degradation. Consequently I must emphasise that the Post Office could in no way be held responsible for the correct transmission and receipt of data using such a system. Post Office responsibility is to ensure that speech communication is satisfactory.

2(a) As regards the question of voltages bridging the insulating gap I think that you and your advisers would agree, on reflection, that the degree of risk would depend upon the size of the voltage and insulating gap concerned. However, I am advised that in the field of personal computing the danger to the network from high voltages is remote and we are therefore, willing to withdraw from the time being the restriction referred to in paragraph 2a of my letter of 11 January.

2(b) The particular interference problem mentioned in my letter is that of converter-type (also known as 'switching') power supplies which can produce interfering frequencies of 20 KHz or more. However, this is only one aspect of the interference problem which can be produced by an undefined attachment to the acoustic coupler. I agree that the problem may not be

caused by the coupler and I am therefore not insisting that this be solved by the coupler. However, if the coupler is unable to prevent the transmission to line of frequencies outside the limits laid down in Technical Guide No 32 it will be necessary for the terminals to be used with the coupler to be evaluated in conjunction with the coupler. This interference problem can, of course, as you point out, occur with electrically connected modems and I am becoming increasingly concerned with this aspect. However, the resources which we have at our disposal are limited and I have consequently decided that at the moment these resources can best be used by dealing with the more pressing problem, i.e. acoustic couplers. By their very nature acoustic couplers are portable and being used in itinerant situations could cause interference on the PSTN which would be extremely difficult to trace.

3 If the acoustically coupled modem stands separately from the personal computer system and the interference problem can be overcome by incorporation of a suitable filter in the modem I can confirm that it will not be necessary for the computer system to undergo an evaluation. However, if the acoustic coupler does not protect the network adequately (paragraph 2[b] of my letter of 11 January refers) or the computer system has an integral modem, an evaluation of the terminal and the modem will be necessary. We will naturally have to react to any increase in the number of applications arising from clarification of this aspect of our policy. The level of evaluation fees raised will be commensurate with the resources employed by the Post Office and this should encourage developers and constructors to produce equipment which is likely to be readily acceptable to the Post Office, thereby minimising our charges.

4 In conclusion, I should like to add that the Post Office in no way wishes to inhibit developments in the sphere of personal computing and I agree that this is a potential source of revenue to the Post Office. However, my responsibility is to ensure, as far as is reasonably possible, that any private attachments to PO services will not adversely affect other users of PO services and this responsibility can only be discharged by our evaluation of private equipment. It may be that the development of an acoustic coupler which contained suitable filtering would be a reasonable solution to the particular problems which you have raised but I must leave this to the technicians to consider.

I am sorry for the delay in replying to you.

26th June 1979 Letter to the Post Office.

Many thanks for your letter of the 8th June. I am delighted to see that we are converging paths as far as this matter is concerned. However, one technical point seems to be outstanding. It is my understanding (and that of my technical advisers) that the 20 KHz interference caused by switching power supplies is a radio transmission. This is picked up by the exchange line acting as an antenna and is therefore, detectable by your engineers' oscilloscope.

However, it is difficult to see how such a signal could be transmitted across the telephone network which has a nominal bandwidth of only 300-3400 Hz. All frequencies above 3400 Hz are filtered out by Post Office equipment; there is no way in which filters in any type of modem (acoustically coupled or otherwise) could eliminate such a radio transmission. A faraday cage built around the DTE might. But if the 200 KHz cannot get beyond the exchange line, why is there a problem? I note with pleasure that you are prepared to waive type approval of personal computers working through acoustic couplers (subject to the resolution of the above problem). Now we seem to have most of the technical problems resolved, could you please clarify the regulatory aspects of usage? For example:

1 Will registration with local Telephone Managers be necessary?

2 Will any restrictions apply to the type of date which may be transmitted?

Please appreciate that I am not looking for trouble! However, I think it would be in everybody's interest if you could provide some form of statement which I could publish through my Personal Computer World 'On The Line' column. This could help to avoid misunderstandings at a later stage. I look forward to hearing from you again.

2nd July 1979 Received acknowledgement of my letter.

10th September, 1979 Letter to the Post Office requesting a reply.

11th October, 1979 Letter to the Post Office requesting a reply.

22nd October, 1979 Letter from the Post Office.

"Thank you for your further letter of 26th June concerning the outstanding points with regard to personal computer communications via the Public Switched

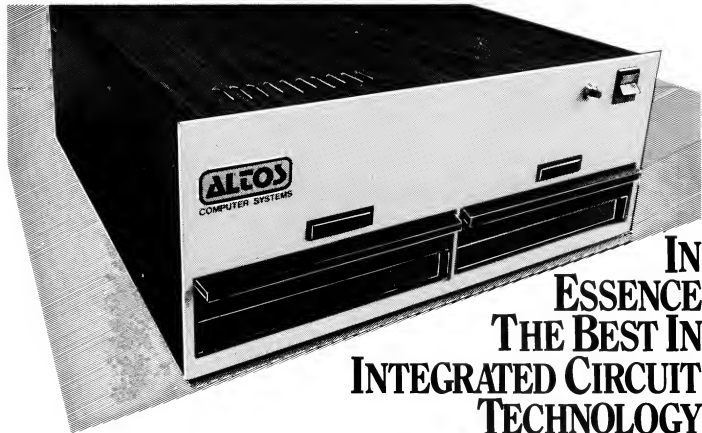

IN ESSENCE THE BEST IN INTEGRATED CIRCUIT TECHNOLOGY

The ALTOS Sun Series ACS 8000 BUSINESS/SCIENTIFIC micro computer creates a new standard in quality and reliability in high technology micro computers.

High Technology

The ACS 8000 is a single board, Z80 disc-based micro computer. It utilises the ultra reliable Shugart 8 inch, 18M compatible, disc drives, double density — single sided, and providing 1 M. byte of data storage. The ACS 8000 features the ultimate in high technology hardware: a fast 4 MHz.Z80CPU,64 kilobytes of 16 K dynamic RAM, 1 kilobyte of 2708 EPROM, an AMD 9511 floating point processor (OPTIONAL) a Western Digital floppy disc controller, a Z80 direct memory access (OPTIONAL), Z80 parallel and serial I/O (two serial RS232 ports, 1 parallel port), and a Z80 CTC Programmable Counter/Timer (real time clock). In essence, the best in integrated circuit technology.

Built-in Reliability

The ACS 8000 is a true single board micro computer. This makes it extremely reliable and maintainable. The board and two Shugart drives are easily accessible and can be removed in less than ten minutes. All electronics are socketed for quick replacement. Complete diagnostic utility software for drives and memory is provided.

Quality Software

Unlimited versatility. The ACS 8000 supports the widely accepted CP/M disc operating system plus basic (Microsoft and CBasic), Cobol, Pascal, and Fortran IV. All available now.

Logitek in conjunction with its own microsoftware house, Interface Software Ltd. of Camberley is able to supply a wide range of proven 'off the shelf' business software including general accounting, word processing, stock control, mailing list etc.

There are already over 1000 micro computer installations using this software. A track record which we consider speaks for itself.

Why 're-invent the wheel' when there is standard software of this quality available now?

ALTOS
SUN-SERIES 8000
LOGITEK

Stop Press!

The Winchester hard disc, singleand multi user ALTOS systems are now available, supporting from 1 to 4 users and providing up to 58 Megabytes of data storage capacity. The systems are truly flexible and allow the ALTOS floppy disc system to be expanded to keep pace with the users requirements.

For a demonstration visit Logitek stands 27 28 at the Microsystems 80 exhibition,

MICROSYSTEMS '80
Wembley Conference Centre London on Jan 30th — Feb 1st

Availability

Logitek carry deep shelf stocks of ALTOS hardware and compatible peripherals.

If you are a dealer who may be interested in promoting ALTOS and/or Interface Software by joining the fast growing network of approved suppliers, contact Logitek.

We can offer you something rather special now.

Approved Suppliers

LONDON
Logic Box Ltd.
Tel: (01) 222 1122

Boyd Microsystems (Watford)
Tel: (01) 950 0303

GLASGOW
Robex
Tel: (041) 221 5401
Aathorol Consultancy Services
Tel: (041) 641 7758

BIRMINGHAM
Soho Computer Systems
Tel: (021) 643 2021

SHEFFIELD
Sheffield Computer Centre
Tel: (0742) 53519

GLoucestershire
Woodtek Computer Centre (Tisbury)
Tel: (06668) 289

DARLINGTON
Vena Consultants
Tel: (0225) 67766

WILTSHIRE
Validata Services (Melkham)
Tel: (0225) 705957

LOGITEK

E.J.C. Electronics Ltd.
All enquiries to:
Portland St., Chorley, Lancs.
Tel 02572 66803

also at:
30 Kelvin Ave.,
Hillington Industrial Estate,
Glasgow G52 4LH
Telex: 777255

ON THE LINE

Telephone Network (PSTN). I am sorry for the delay in replying.

You raised the question of interference and in particular interference at frequencies above 3400 Hz. Although the nominal frequency band generally offered over the PSTN is between 300 and 3400 Hz the Post Office network (including customer's local lines) is in fact capable of carrying much higher frequencies (which are incidentally not normally filtered out by PO exchange equipment as stated in your letter). This capability is, for example, utilized by the Post Office in the use of fdm carrier systems in the PO High Frequency (HF) network and in certain local network services. Consequently Technical Guide No 32 lays down frequency spectrum requirements not only for signals up to 3400 Hz (Diagram 3) but also above 3400 Hz (Diagram 4). The spectral roll-off characteristics of Diagram 4 are in particular designed to:

- 1 avoid interference with the PO HF network (by minimising crosstalk at higher frequencies, preventing overspill into adjacent fdm channels).
- 2 avoid interference with services which exploit the HF capabilities of the local network.
- 3 prevent 'beat' signals produced by attachment signal harmonics and the 8KHz sampling frequency of wide-spread PCM systems.

In view of this explanation I hope you will accept that signals above 3400 Hz from attachments could cause

network problems and interference to other users of PO services. It follows that the evaluation of the personal computer systems connected behind acoustically coupled modems will be necessary unless the modem involved incorporates suitable filtering.

With regard to the actual use of personal computers via acoustically coupled modems over the PSTN I confirm that it will be necessary for Post Office subscribers to first obtain the written consent of their local Telephone Area (Sales) Office.

As mentioned in my letter of 11 January the general conditions under which telephone service is provided and private attachments may be used are as laid down in the Post Office Telecommunication Scheme 1976 (and amendments). From the outline description of the system which you have supplied I do not envisage that any additional restrictions (other than the technical ones referred to above) will be required subject to the running of the systems falling within the ambit of the General Licence for Private Attachments to Post Office Telecommunication Installations which was published in the London Gazette on 1 July 1977.

I hope that this letter clarifies the outstanding issues and will enable you to offer the appropriate advice to personal computer users. The interference problem remains to be resolved of course, and I must leave you to consider how best to approach its resolution.

So that is where it presently stands. In case you got lost the current arrangement is as follows:

- 1 You can transmit data over the public telephone network using an approved acoustic coupler.
- 2 Your computer system does not need to receive Post Office type approval for this.
- 3 The only exception to points 1 and 2 above are those micro computers which employ switching board supplies. (I hope someone at Microsense is reading this).
- 4 You need to write to your local Telephone Area (Sales) Office to get their go-ahead first.

The only issue outstanding is that of the switching board supply. The Post Office clearly does not understand that this is caused by an electro-magnetic emanation from the board supply concerned and has nothing whatsoever to do with acoustic couplers. Indeed, the same problem will occur when using Post Office modems. Again the problem will occur if you are playing Star Trek on your Apple near a telephone line even if you have no communications equipment involved. I will pursue this matter further with the Post Office to try to get it resolved.

I now propose to try and persuade the Post Office to let us communicate through hardwired modems with the use of a barrier kit for safety reasons.

I will keep you posted (*sic*) on developments.

Z-89 ALL-IN-ONE COMPUTER

The new all-in-one computer from Zenith is the most versatile microcomputer available today.

- 'Intelligent' video terminal
- two Z80 microprocessors
- floppy disc storage system
- expandable to 48K RAM

Easy to programme. Simple to operate. It is capable of a multitude of high-speed functions and speaks the language of today's most popular software. Price from £1570

The most advanced microcomputer yet.

WH-14 SERIAL PRINTER

With a compact table-top configuration, the WH-14 is designed for a broad variety of uses in any computing environment.

Microprocessor based, it is compatible with any computer providing standard RS-232C or 20mA current loop interface connections. Price £510

Prices exclude VAT & delivery charges.

IMMEDIATE
DELIVERY
AVAILABLE

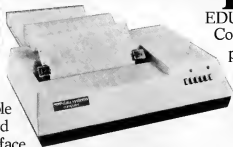

For complete specifications of these and all Zenith Data Systems products contact: Heath Electronics (U.K.) Ltd., Zenith Data Systems Division, Dept (PCW2), Bristol Road, Gloucester, GL2 6EE Telephone: (0452) 29451.

EDUCATION COURSES

Courses in microprocessors and programming are also available.

Zenith
data
systems



THE ULTIMATE IN MICROCOMPUTERS

How to get on with microcomputers

Commodore, manufacturers of PET, Britain's best selling micro-computer, are running appreciation seminars using Commodore PET hardware to illustrate lectures and provide practical experience. Here's your chance to learn from some of the country's leading experts in this field.

MICROCOMPUTERS AND THE BUSINESSMAN

How to computerise your business. What are the advantages, savings, limitations, costs and timescales? Lectures supported by Accounting, Business Information, Payroll, Word-processing and other software packages.

Jan 14th Skyway, Heathrow
 Feb 11th Skyway, Heathrow
 Feb 25th The Motor Crest, Newcastle-under-Lyme (Staffs)
 Mar 10th Skyway, Heathrow
 Apr 14th Excelsior, Birmingham

PET COMPUTERS IN CONTROL SYSTEMS

How PET computers can be used for monitoring and controlling industrial or laboratory equipment. And as a development tool for dedicated system software.

Jan 15th Skyway, Heathrow
 Feb 12th Skyway, Heathrow
 Feb 26th The Motor Crest, Newcastle-under-Lyme (Staffs)
 Mar 10th Skyway, Heathrow
 Apr 15th Excelsior, Manchester

Seminars last the whole day and include the cost of lunch.

You can book simply by completing the form below and sending it together with your cheque for £57.50 inc. VAT to Commodore Systems, Seminar Bookings, 888 Leigh Road, Slough, Berks.

We are also running intensive 2 & 3 day residential training courses on the following: Basic for Beginners; Advanced Basic Programming; Disk Programming; and Assembler Language. Tick the appropriate box in coupon below for further details. PET Computers start from as little as £350.

BOOKING FORM

Commodore Systems, Seminar Bookings,
 888 Leigh Road, Slough, Berks.
 Please send this booking form to the address above
 on being full payment of £57.50 inc. VAT per
 seminar (4 cheques payable to Commodore Systems,
 Machines Ltd (VAT receipts will be issued).
 Indicate here if you would like further details on any
 of the following:

- Residential Training courses
 News and Dealer
 Product Demonstration

State Seminar required _____
 Date required _____ (1st choice) _____ (2nd choice) _____
 Name(s) _____
 Address _____
 Telephone No. _____
 Enclose a cheque no. _____ for £ _____ date _____ Signature _____ P.S.

commodore
 We make small computers big business.

You can Count on Us for your COMPUTER PERIPHERALS - call the ABACUS WAREHOUSE

*Please compare
 our Prices
 and Delivery!*

Printers	Texas Instruments 810 (RO)	£1250	EX-STOCK
	150 CPS Bi-directional		
	Texas Instruments 890 (KSR)	£1465	EX-STOCK
	150 CPS Bi-directional		
	NEC Spewriter 5510 (RO) 55 CPS	£1969	EX-STOCK
Terminals	Bi-directional Daisywheel		
	NEC Spewriter 5520 (KSR) 55 x 48	£2026	EX-STOCK
	Bi-directional Daisywheel		
S-100 Systems	Hazeltine 1410	£ 587	EX-STOCK
	Hazeltine 1510	£ 827	EX-STOCK
	(Top of the line, numeric keypad etc.)		
	MCS 122 22 Slot Mframe complete with power supply + lan	£403	EX-STOCK
	PT 208 Integral Screen, 60K RAM, 2 x 5" floppies	£3535	EX-STOCK
PT 212 Integral Screen, 60K RAM, 2 x 8" floppies	£4497	EX-STOCK	
TF 12 12 Slot Mframe complete with power supply + lan (case will accommodate 3 x 5" floppies)	£ 359	EX-STOCK	

**Why pay more?
 Why wait longer?**



See all these and more at
 the Abacus Warehouse
 call Bob Brown on 01 580-8841

62, New Cavendish Street, London W1M 7LD

Abacus Computers Limited Telex 8813065 (Abacus)

FORGING LINKS WITH THE OUTSIDE WORLD

The advent of the microprocessor and the relatively cheap personal computer has been accompanied by frenzied activity in many quarters to apply them in the obvious business and commercial fields -- after all, most micros have to earn their living. Marketing of both software and hardware has been concentrated on the office environment . . . be it the accountant, the solicitor or the small business of any kind. Less well served have been the fields of industrial and laboratory instrumentation and control. Keen to correct this uneven investment of effort, Alan Mills and K.T. Kibase of 3D Digital Design and Development examine the design and "connective abilities" of the IEEE 488 bus.



A peep inside a 16-channel analogue to digital converter -- typically used to handle signals from devices such as thermometers, pH meters and pressure transducers.

Understandably, any imbalance of microcomputer research stems largely from a lack of knowledge and experience on the part of both sellers and buyers. Now, however, the possibilities inherent in the combination of cheap computing power plus transducers, actuators, detectors, and instruments of various types is becoming all too apparent to many potential users. The great stumbling block, of course, is the interface. One can buy a computer in the region of £500, which is cheap enough for it to be installed as a dedicated controller, even if only for periods at a time; but how do you connect it up to the other devices?

The need for a standard interface has long been recognised, but international standards have lengthy gestation periods and take even longer to achieve general acceptance.

The one standard interface that is approaching respectable maturity is designated the IEEE-488 (1978). This is the bus that merits study by all computer users intent on extending beyond the processor-discs-printer triangle.

HERE COMES THE BUS

Also known as the General Purpose Instrumentation Bus (GPIB), it was conceived by Hewlett-Packard, the instrument manufacturers; they proposed its adoption as an international standard to the Institute of Electrical & Electronic

Engineers in America, and also to the International Electrotechnical Commission, back in 1974. In 1975 it was accepted as IEEE standard number 488, hence the designation IEEE-488 (1975). The revision of 1978 made only minor changes. The IEC standard is Publication No. 625-1.

Over the last few years an increasing number of instrument manufacturers have incorporated IEEE-488 interfaces into their products, following Hewlett-Packard's lead; nowadays it is becoming a common option.

The great breakthrough, as far as most readers are concerned, came with the launching of the Commodore PET. Designed with an integral IEEE-488 bus, it was aimed at the inexpensive end of the market -- the hang glider to H-P's Concorde.

WHAT IS IT?

The bus consists of a set of 16 parallel wires (plus ground wires) along which signals are passed between devices that may be simultaneously connected. Eight lines are used for bit-parallel byte serial data transfers. Three lines are used to ensure orderly transfer of data by "handshaking" (i.e. signals going back and forth to synchronize transmission and reception -- two-wire handshaking is the common rule, but with more than two

devices connected together three wires become necessary). The remaining five lines are used for bus management functions.

Devices that can be connected to the bus are described either as "Talkers" (if they put information out onto the bus), "Listeners" (if they receive information from the bus), or "Controllers" (if in addition to Talking and/or Listening, they take charge of the bus management functions).

Only one Controller may be active on the bus at any one time, although it is possible to have a bus without a Controller e.g. a Talker connected to two Listeners.

Also, to avoid confusion, only one Talker may be active on the bus at any one time, although it may be talking to more than one Listener.

As many as sixteen devices plus a Controller may be simultaneously connected in star, ring, or linear configurations. Each device has an address number (0 thru' 15) assigned to it.

A critical point to appreciate is that, generally speaking, Talkers only talk when the Controller has previously told them they may talk, and similarly Listeners only listen on previous instruction from the Controller.

The Controller can also de-activate devices on the bus by issuing UNLISTEN and UNTALK commands, known as

universal commands.

Examples of Talkers include paper-tape readers, analog-to-digital converters and keyboards. Paper-tape punches, X-Y plotters, digital-to-analog converters, stepper motors, and display devices are Listeners. Combined Talker/Listeners could be disc drives, tape cassette units, data loggers, and VDUs; at any instant they either talk, listen, or are deactivated.

The best example of a Controller is the CBM PET which can talk, listen and manage the bus.

In many applications the decisions about which device is to talk, which device(s) is (are) to listen, are made entirely by the Controller, so that, for example, the sequence of data transactions may be completely determined by the statements within a BASIC program running in a PET.

INTERRUPT FACILITIES

The bus is designed to permit a form of interrupt capability, in that a device may signal a SERVICE REQUEST (SRQ) by putting a logic level on the wire reserved for that purpose. On noticing that service has been requested the Controller must bring the present bus transaction to an orderly close, and then proceed to find out which device has interrupted. The protocol permits two ways of doing this, either by "Parallel Polling" (i.e. asking them all at once) or "Serial Polling" (asking for them each in turn).

Unfortunately, the CBM PET does not implement these latter features, or some of the other more sophisticated facilities of the bus protocol. It economises in other ways, too, departing in a number of minor instances from the recommended IEEE-488 standard (e.g. connector style). In the interest of fairness, be noted that polling could be implemented in 6502 machine code, but this is only recommended to those who make a habit of treading boldly.

The PET, however, does have the tremendous advantage of addressing over the bus in BASIC, so that simple BASIC functions like PRINT and GET may be used in programs to put data out to or bring it in from external devices.

In fact, the internal architecture of the PET is such that its keyboard, two cassette ports, and screen, are treated as IEEE-488 devices with the first four device address numbers, 0 to 3, assigned accordingly. By logical extension, the Commodore discs and printer also use the IEEE-488 interface.

AREAS OF APPLICATION

With more people appreciating the usefulness of the IEEE-488 bus in the industrial and laboratory environments, the PET is becoming very popular with scientists and engineers as a machine that can be brought into contact with the outside world.

The drawback until recently has been that IEEE-488 instruments have tended to be fairly expensive, sometimes many times the price of a PET. Now, however, firms like 3D Digital Design & Development are making available a number of peripheral devices designed specifically for use with the PET form of the IEEE-488 bus, even down to using the same style of connection.

Analog voltage or current signals from whatever source may be sensed or monitored using a 16-channel analog-to-digital converter unit. By simply connecting the voltage into a front panel socket of the unit, and connecting the unit to the PET with the double-ended bus cable, the voltage may be monitored by executing the following simple program:

```
10 OPEN 1,8,6
20 GET #1,AS
30 PRINT ASC (AS)
40 GO TO 20
```

Since the convertor is of 8-bit resolution the value printed to the screen will be between 0 and 256. The input amplifiers are usually set to, say, 5 volts in which case the conversion of the value back to a voltage is a simple matter of multiplying by the appropriate scaling factor ($\frac{5}{256}$). In the OPEN statement above, the device address (8) and channel number (6) are assigned to logical file no. 1.

An 8-channel 8-bit resolution digital-to-analog convertor unit allows analog voltages to be generated under program control by equally simple program state-

ments, except that values are PRINTed out to the convertor unit. Each of the output channels has its own digital latch and digital-to-analog convertor, so that a voltage sent to a channel stays there until changed from the PET.

Another interesting and useful device is a 16-channel relay closure unit containing 16 reed relays. The relay contacts are brought to front panel sockets with LED indicators to show the state of each relay. The relays may be set on or off in any desired sequence under program control by simple BASIC statements.

There is also a versatile digital data acquisition interface used for connecting up digital instruments which, although without an IEEE-488 interface, nevertheless provides digital output signals (as if often the case), such as digital voltmeters, frequency counters, transient recorders. This interface may also be used to monitor as many as 64 simple contact closures or logic levels.

Any combination of these units can be simultaneously connected on the IEEE-488 bus, so that an enormous range of possible systems can be built up to monitor, indicate, measure, and control.

By introducing such a system into a small manufacturing plant, various levels of process automation can be achieved in a cheap and relatively painless way. Temperatures may be measured, indicator lamps switched on, heaters turned up, motors started, valves closed, shaft rotations counted — the possibilities are virtually limitless. The automation of testing, or of laboratory experiments, can be achieved with a minimum of time and effort if IEEE-488 compatible devices are chosen, and the PET is used as a controlling computer.

Indeed, the IEEE-488 is such a boon to the black art of interfacing that it will almost certainly be adopted by some future computers. Already the new Powerhouse II is available with the IEEE-488 interface.

The second half of this article, to appear soon, will take a look at actual case studies where the PET and IEEE-488 peripherals have been installed into working situations.

The IEEE-488 bus uses a 16-line cable to quickly link up any instruments equipped with appropriate interface circuitry into a system. Data transfer is byte-serial, bit-parallel at rates as high as 1 megabit per second.

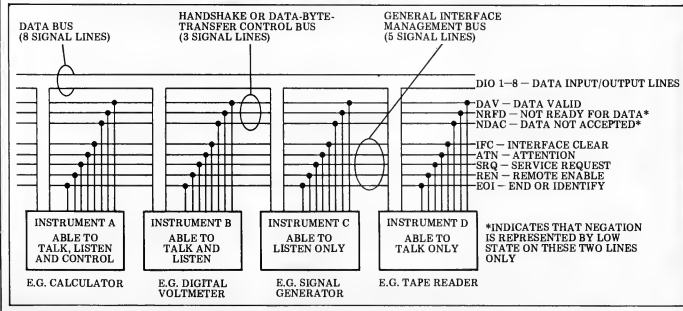

THE COMPLETE PASCAL

BY SUE EISENBACH AND CHRIS SADLER

CHAPTER 6 DATA STRUCTURES 2-RECORDS AND FILES

Computer programmers, the languages they program in and sometimes even the computers on which these programs run tend to be biased either towards number-crunching (immense calculations) or data-processing (huge quantities of information). This chapter is intended to provide an introduction to PASCAL's approach to the second of these.

Computers have traditionally been employed in the fields of scientific research and business data-processing. The different requirements of these two types of user have produced opposing specialisms amongst computer professionals — conflicting designs and configurations of both hardware and software; and most importantly from our point of view, programming languages with differing facilities and capabilities. Scientific languages tend to standardize on specialized and sophisticated mathematical functions and to leave non-standard and bulk-data handling features which are consequently provided (with greater or lesser degrees of effectiveness) by the individual implementors of the language. This reflects perfectly reasonably the general format of a mathematical problem where complex operations need to be performed on a relatively restricted amount of data.

Commercial languages, however, often don't provide sophisticated or even convenient mathematical functions since their processing tends to consist of more routine operations but with much larger quantities of data. This is not to suggest that a good sorting algorithm is not every bit as complex as say, a Fourier transform module, but while the latter operates on the supplied data to produce completely different data, the former works *with* data, re-ordering it but not actually changing any values. In any case, in a typical data-processing problem, the quantity of supplied data is generally so large that no more than a small fraction can fit into the machine at one time — the organizational problems associated with containing this data in machine-readable form and of making it available to the program in a controlled and ordered manner dominate these commercial languages.

While the data is being manipulated within the machine it is grouped together in structures called *records*. Loosely, a record is a number of data items, usually of different types, which need to be associated in some way, probably because they all pertain to a single entity. A second record would contain the corresponding information, in the same format, pertaining to another entity, and so on. An entry in

a telephone directory, i.e. Name, Address . . . Telephone No. is a simple example of a record.

A *file* is a data structure external to the program and consists of a collection of records. The characteristics of any particular file will depend not only on the size and number of the records it is to contain, but also on the *medium* on which the file is being stored. Magnetic tape files are called *sequential files* because records are stored in sequence and can only be accessed as such — i.e. start at the beginning and deal with each record in turn. Clearly, quite a bit of complicated programming has to be done at system level to

control the tape drive and the motion of data through the read/write tape heads. This software can usually be initiated by fairly simple calls embedded in the programming language. Wirth's standard PASCAL provides a set of these sequential file-handling facilities.

PASCAL, however, was designed when discs were considered as a sort of extension of the memory in large computer systems and were too expensive and bulky to be a suitable medium of data file storage. The advent of small hard disc packs and reliable diskettes has put this medium within reach of smaller system users making it reasona-

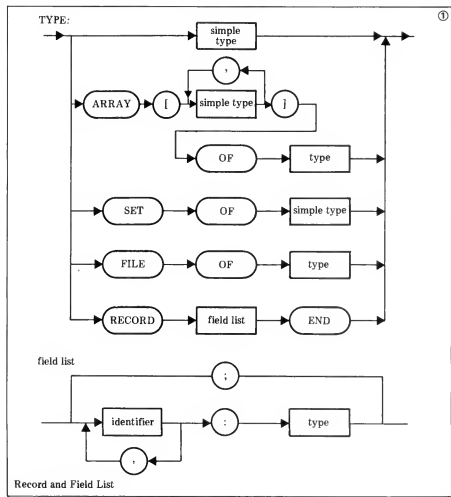

```

1 PROGRAM FIRSTILL ;
2 TYPE STOCK=RECORD ;
3     NUMBER:INTEGER ;
4     NAME:PACKED ARRAY [1..24] OF CHAR ;
5     PRICE:REAL ;
6     QUANTITY:INTEGER ;
7     VAT:1.000 ;
8     END ; (*RECORD*)
9 VAR ANSWER:CHAR ;
10 ITEM:ARRAY[0..43] OF STOCK ;
11 ACCEPTABLE:=SET OF 'A'..'Z' ;
12 I:=1..4 ;
13 PROCEDURE SETUP ;
14 BEGIN
15     ITEM[0].NAME := 'DAISY BELL PRINTER' ;
16     ITEM[1].NAME := 'MICRO DOT MATRIX PRINTER' ;
17     ITEM[2].NAME := 'NCR PAPER' ;
18     ITEM[3].NAME := 'CONSTANT PAPER' ;
19     ITEM[4].NAME := 'CARBON RIBBON' ;
20     FOR I := 0 TO 4 DO
21     BEGIN
22         ITEM[I].NUMBER := I ;
23         ITEM[I].QUANTITY := 0 ;
24         PAGE (OUTPUT) ;
25         WRITELN ('PLEASE TYPE IN TODAY'S PRICE FOR ', ITEM[I].NAME) ;
26         WRITE (' FOLLOWED BY THE VAT RATE AS A X =>') ;
27         READ (ITEM[I].PRICE) ; READLN (ITEM[I].VAT) ;
28     END ;
29 END ; (*SETUP*)
30 PROCEDURE HELP ;
31 BEGIN
32     PAGE (OUTPUT) ;
33     WRITELN ('TYPE ' T TO SEE THIS DISPLAY.') ;
34     WRITELN (' T TO PRODUCE A TILL SLIP.') ;
35     WRITELN (' S TO PRODUCE A SUMMARY OF THE DAY'S TRANSACTIONS.') ;
36     WRITELN (' X TO EXIT FROM THIS PROGRAM.') ;
37     WRITELN ;
38     WRITE ('WHEN PRODUCING A TILL SLIP TYPE EACH ITEM NUMBER FINISHING ') ;
39     WRITELN ('WITH A -1.') ;
40     WRITE (' HIT THE RETURN KEY TO CONTINUE.') ;
41 END ; (*HELP*)
42 PROCEDURE TILLSLIP ;
43 VAR TOTAL, TAX:REAL ;
44 NUM:INTEGER ;
45 BEGIN
46     TOTAL := 0 ;
47     TAX := 0 ;
48     READLN (NUM) ;
49     WHILE (NUM > -1) AND (NUM < 5) DO
50     BEGIN
51         WRITELN (ITEM[NUM].NAME, ' ', ITEM[NUM].PRICE) ;
52         ITEM[NUM].QUANTITY:=ITEM[NUM].QUANTITY+1 ;
53         TOTAL:=TOTAL+ITEM[NUM].PRICE ;
54         TAX:=TAX+0.01*ITEM[NUM].VAT ;
55         READLN (NUM) ;
56     END ;
57     WRITELN ;
58     WRITELN ('VAT ', TAX) ;
59     WRITELN ('TOTAL ', TOTAL+TAX) ;
60     READLN ;
61     END ; (*TILLSLIP*)
62
63 PROCEDURE SUMMARY ;
64 CONST TAB = ' ' ;
65 VAR TOTAL, TAX:REAL ;
66 BEGIN
67     TOTAL:=0 ;
68     TAX := 0 ;
69     PAGE (OUTPUT) ;
70     WRITELN ('NAME', 'PRICE', 'QUANTITY', 'QTY SOLD', 'AMOUNT') ;
71     FOR I:=0 TO 4 DO
72     BEGIN
73         WRITELN (ITEM[I].NAME, TAB, ITEM[I].QUANTITY, TAB,
74                 ITEM[I].QUANTITY*ITEM[I].PRICE) ;
75         TAX := TAX + 0.01*ITEM[I].VAT*ITEM[I].QUANTITY ;
76         TOTAL := TOTAL + ITEM[I].PRICE * ITEM[I].QUANTITY ;
77     END ;
78     WRITELN ;
79     WRITELN ('SUBTOTAL = ', TOTAL) ;
80     WRITELN ('VAT = ', TAX) ;
81     WRITELN ('TOTAL = ', TOTAL + TAX) ;
82     READLN ;
83     END ; (*SUMMARY*)
84 BEGIN (*MAIN PROGRAM*)
85     SETUP ;
86     ACCEPTABLE := ('E', 'H', 'S', 'T') ;
87     WRITELN ('TYPE H FOR HELP.') ;
88     REPEAT
89         READLN (ANSWER) ;
90         IF NOT (ANSWER IN ACCEPTABLE) THEN ANSWER := 'H' ;
91         CASE ANSWER OF
92             'E' : WRITELN ('GOOD BYE') ;
93             'H' : HELP ;
94             'S' : SUMMARY ;
95             'T' : TILLSLIP ;
96         END ; (*CASE*)
97     UNTIL ANSWER = 'E' ;
98     END .

```

are not directly accessible via computer indices like array elements, but must be referenced by a fixed field identifier.

The record is declared in a TYPE statement in which is stipulated both the field identifiers and their corresponding types. The syntax diagram in Box 1 shows the reserved words required for this declaration, together with the format for the field list. Note that a field within a record could be another record, or even an array.

As an example of the uses of records in a program look at program FIRSTILL in Box 2. The program represents a cash register for a small shop which sells printers and stationery for microcomputers. A tally is kept of every sale so that, in addition to producing a slip for the customer, a daily summary can be output at closing time. The record type STOCK is declared in lines 2 to 8 with the field list laid out in lines 3 to 7. The field NAME is declared as a PACKED ARRAY. Packing is a device whereby elements of a particular data type are packed into the smallest amount of memory needed - e.g. a bit for a BOOLEAN, a byte for a CHAR etc. Numerical array elements frequently incur too large an overhead to make packing worthwhile but BOOLEANs and CHARs usually repay packing with substantial space saving. The PACKED ARRAY OF CHAR is formally defined as a string which we shall be dealing with at some length in the next chapter.

In line 10, array ITEM is declared as of type STOCK which implies that 5 records will be set aside in memory for this data structure. Each record can be referenced by a different value of the array index. Line 15 and the rest of procedure SET UP provide illustrations of the method by which individual fields within a record are referenced. The record name and the field name, separated by a ., must both be supplied, and lines 15 to 19 refer to the same field in different records. Lines 22 and 23 on the other hand refer to different fields in the same record (selected by I). The instruction in line 24 clears the screen (in UCSD PASCAL).

Lines 25 to 27 reflect today's uncertain commercial climate by offering the user an opportunity to input altered prices and VAT rates.

Procedure HELP reveals the menu-driven nature of the program, since each of the different functions may be selected by inputting a single character at the keyboard. The most important key to remember, especially for an inexperienced teller, is 'H' which executes HELP itself. The two procedures TILLSLIP and SUMMARY show how record fields can be manipulated like ordinary variables although the referencing scheme makes them appear a bit long-winded. This can be avoided by means of the WITH statement whose syntax diagram is given in Box 3. When the record identifier is given in the "variable" box, all identifiers appearing in the "statement" are checked by the compiler against the field names pertaining to that record as well as the normal declared identifiers appropriate to that procedure. The record name is thus taken as a default for the duration of the statement. This is illustrated in the new version of SUMMARY appearing in Box 4, lines 10 to 15.

ble to discuss direct-access files. As with the mag. tape drive, special system software is required to direct the read/write heads to the correct track and sector on the disc and to control the flow of data to and from this location. However, all the data is spread over the surface of the disc and is consequently all equally accessible directly - hence the name.

Although this software is utilized at operating system level (in the form of file-handling and/or editing utilities), high-level language calls are seldom available to the programmer so that most disc data-files tend to be sequential. UCSD PASCAL is an exception to this general rule and we feel that direct-

access facilities are sufficiently important to be incorporated in any future standard PASCAL. It is with a small degree of reluctance therefore that we abandon Wirth PASCAL in Section 4 to describe the UCSD file-handling facilities.

Records

The record was defined in the previous section as a grouping of associated data items. These data items are known as the fields of the record. There is no restriction on the type which each field may be so that the structure is distinct from the array where all elements must be of the same type. In addition, fields

The Paper Tiger™ is here.



The Paper Tiger sets a new standard for low-cost impact printers. More capability. More versatility. For just **£585**.

You get a full upper and lower case 96-character set. Eight software-selectable character sizes. Plain paper, multiple copies. Forms length control. Parallel and serial interfaces. Multiple line buffer. Tractor feed. Automatic re-inking. 80 and 132 columns.

It's all standard with the Paper Tiger.

Unbeatable capability.

The Paper Tiger prints just about any paper form you need. From address labels to multicopy invoices and legal-size reports.

Adjust the tractor width from 1 3/4 to 9 1/2 inches. Choose from 8 switch-selectable forms lengths. Print 6 or 8 lines per inch.

Unmatched versatility.

Want graphics? Add the Paper Tiger's software-selectable full dot plotting graphics. Print illustrations, block letters, charts, graphs, and more.

Need a bigger buffer? The Paper Tiger features an optional 2K-byte memory that holds a full 24 by 80 CRT screen.

Feature \ Printer	Integral Data 440	Tally 1200	Lear-Seigler 300	Texas Instruments 810	Centronics 779-2
96-character ASCII set, upper and lower case	YES	OPTION	YES	OPTION	NO
Software-selectable character sizes	YES	NO	NO	OPTION	NO
Throughput, lines per minute @ 10 char./line @ 132 char./line	275 42	100 40	Data not available	440 64	130 21
Parallel and RS-232 serial interfaces standard	YES	NO	NO	NO	NO
CRT screen buffer	OPTION	NO	OPTION	NO	NO
Footprint (W x D = sq. ft.)	1.37	3.45	3.18	3.58	2.44
Weight (lbs.)	20	64	50	55	45
Forms length control	YES	OPTION	YES	OPTION	NO
Full dot plotting graphics	OPTION	NO	NO	NO	NO
Unit Price + VAT, P & P	£585	£1,500+	N/A	£1450	£995

Comparison data from manufacturers' current literature for 60 Hz operation.

And there's more.

The Paper Tiger is small, lightweight, and compact. That's because it's designed especially to work in small computer systems.

And it's built rugged and simple. For high reliability and easy maintenance. Just like the thousands of IDS printers already in the field.

See for yourself.

Check the comparison chart. Find out why this Paper Tiger sets a new standard for low-cost impact printers.

For more information, write or call:

Teleprinter Equipment Ltd.,
70/82 Akeman Street, Tring, Herts.
Telephone: (044282) 4011 (20 lines)
Telex: 82362 BATECO G.



TELEPRINTER EQUIPMENT LTD

WALES LEADING
SYSTEMS HOUSE



14 CHEPSTOW ROAD
NEWPORT, GWENT.
50528 / 841691 / 63310

Incorporating (Microcourier)

At Micromedia we are usually asked for Complete Business Systems, here are a few examples.

Purchase Price	Lease P/M
15.750	356.90
8.250	186.95
5.950	134.83

Accounting Package Sales Invoicing / Credit Controls
Payroll on Equinox 300, with 10 Megabyte Disk, visual
display unit and printer.

Purchase Accounts, Sales Accounts, Payroll on Cromemco
System III with work station, visual display unit and
180 c.p.s. printer.

Word Processing, Payroll, Accounts, on North Star Horizon
with printer visual display unit.

Call us for a quotation on

Cromemco II & III
North Star Horizon
Alpha Micro
Compucolour II
Commodore Pet
Equinox 200, 300E 400
Industrial Micro Systems

APPLICATION SOFTWARE

Mailing Lists
Data Base Management
Accounting Suites
Stock Controls
Simplex Linear Programming
Personel Records
Fleet Maintenance Records
Word Processing
Pert (Critical Path Analysis)
Purchase Ledger
Sales Ledger
Medical Records

These are a selection from the
range please call us to discuss
your particular application.

We specialize in systems for Business Industry and Education and have
specialist staff to discuss your applications.

Visual Display Units

	From £
Adds Regent	605
Hazeltine	590
Beehive	775
Cromemco 3102	1050
Elbit 1920/II	575
Elbit 1920/30x	750
Infoton 100	610
Lear Siegler ADM 3A	595
ADM 3A with graphics	1295
Pericom	985

Printers

	From £
Anadex DP800	575
IKI E T 5200	485
Teletype 43 KSR	840
DEC LA 34	795
DEC LA 36	905
DEC LA 120 KSR	1150
Diablo 1640 RO	1998
Diablo 1640 KSR	2342
Texas 743	995
Texas 810	1450
Tally Range from	1895

Odds 'n Sods

M22 Paper Tape Reader	£	975
Punch		
M33 Paper Tape Reader		450
M63 Paper Tape Reader		
Punch		1495
Servogor Graphic Plotter		2750
Sigma Graphic Option		
Controller		2168
Single side mini Diskettes		
Per 10		30
Single side B" Diskettes		35
Per 10		35
C12 Cassettes Per 10		475

Large range of computer books
send SAE for list.

OEM TERMS & QUANTITY DISCOUNTS AVAILABLE WRITE FOR DETAILS

```

73 PROCEDURE TILLSLIP ;
74 VAR TOTAL, TAX : REAL ;
75 NUM : INTEGER ;
76 BEGIN
77   TOTAL := 0 ;
78   TAX := 0 ;
79   READLN (NUM) ;
80   WHILE (NUM > 0) AND (NUM <= TOTNUM) DO
81     WITH ITEMNUM DO
82       BEGIN
83         WRITELN(NAME, ' ', PRICE) ;
84         TOTQUANTITY := TOTQUANTITY + 1 ;
85         QUANTITYSOLD := QUANTITYSOLD + 1 ;
86         TOTAL := TOTAL + PRICE ;
87         TAX := TAX + 0.01*VAT*PRICE ;
88         READLN (NUM) ;
89       END (#WITH#) ;
90   DAYTAX := DAYTAX + TAX ;
91   DAYTOTAL := DAYTOTAL + TOTAL ;
92   WRITELN ;
93   WRITELN ('VAT ', TAX) ;
94   WRITELN ('TOTAL ', TOTAL + TAX) ;
95   READLN ;
96   END ; (#TILLSLIP#) ;
97
98 PROCEDURE DAYSTILL ;
99 BEGIN
100  WRITELN ('SUBTOTAL = ', DAYTOTAL) ;
101  WRITELN ('VAT = ', DAYTAX) ;
102  WRITELN ('TOTAL = ', DAYTOTAL + DAYTAX) ;
103  READLN ;
104  END ; (#DAYSTILL#) ;
105
106 PROCEDURE WEEK ;
107 VAR I : INTEGER ;
108 BEGIN
109  FOR I := 1 TO TOTNUM DO
110    WITH ITEM I DO
111      BEGIN
112        WRITE (NUMBER, ' ', NAME, ' ', PRICE, ' ') ;
113        WRITE (TOTQUANTITY, ' ', QUANTITYSOLD) ;
114        IF REORDERLEVEL > TOTQUANTITY - QUANTITYSOLD
115          THEN WRITE (' Y ')
116          ELSE WRITE (' N ') ;
117        WRITELN (VAT) ;
118        QUANTITYSOLD := 0
119        END ; (#WITH#) ;
120    END ; (#FOR#) ;
121  READLN ;
122  END ; (#WEEK#) ;
123
124 PROCEDURE AMENDFILE ;
125 VAR NUM, FIELD : INTEGER ;
126 CONT : CHAR ;
127 PROCEDURE RECMENU ;
128 BEGIN
129   WRITELN ('TYPE 0 FOR NO CHANGES.') ;
130   WRITELN (' 1 TO ALTER A NAME.') ;
131   WRITELN (' 2 TO ALTER A PRICE.') ;
132   WRITELN (' 3 TO ALTER A CURRENT STOCK LEVEL.') ;
133   WRITELN (' 4 TO ALTER A WEEKLY SALES LEVEL.') ;
134   WRITELN (' 5 TO ALTER A REORDERING LEVEL.') ;
135   WRITELN (' 6 TO ALTER A VAT RATE.') ;
136   READLN ;
137   END ; (#RCMENU#) ;
138
139 PROCEDURE NCHANGE ;
140 BEGIN
141   WRITELN ('NO CHANGES MADE.') ; READLN ;
142   END ; (#NCHANGE#) ;
143 PROCEDURE NAMECHANGE ;
144 BEGIN
145   WRITELN ('OLD NAME -->', ITEMNUM, NAME) ;
146   WRITE ('NEW NAME -->') ;
147   READLN (NEWNAME, NAME) ;
148   END ; (#NAMECHANGE#) ;
149
150 PROCEDURE PRICECHANGE ;
151 BEGIN
152   WRITELN ('OLD PRICE -->', ITEMNUM, PRICE) ;
153   WRITE ('NEW PRICE -->') ;
154   READLN (ITEMNUM, PRICE) ;
155   END ; (#PRICECHANGE#) ;
156
157 PROCEDURE TOTCHANGE ;
158 BEGIN
159   WRITELN ('OLD STOCK LEVEL -->', ITEMNUM, TOTQUANTITY) ;
160   WRITE ('NEW STOCK LEVEL -->') ;
161   READLN (ITEMNUM, TOTQUANTITY) ;
162   END ; (#TOTCHANGE#) ;
163
164 PROCEDURE SOLDCHANGE ;
165 BEGIN
166   WRITELN ('NUMBER SOLD -->', ITEMNUM, QUANTITYSOLD) ;
167   WRITE ('NEW NUMBER SOLD -->') ;
168   READLN (ITEMNUM, QUANTITYSOLD) ;
169   END ; (#SOLDCHANGE#) ;
170
171 PROCEDURE ORDERCHANGE ;
172 BEGIN
173   WRITELN ('OLD REORDERING LEVEL -->', ITEMNUM, REORDERLEVEL) ;
174   WRITE ('NEW REORDERING LEVEL -->') ;
175   READLN (ITEMNUM, REORDERLEVEL) ;
176   END ; (#ORDERCHANGE#) ;
177 PROCEDURE VATCHANGE ;
178 BEGIN
179   WRITELN ('OLD VAT RATE -->', ITEMNUM, VAT) ;
180   WRITE ('NEW VAT RATE -->') ;
181   READLN (ITEMNUM, VAT) ;
182   END ; (#VATCHANGE#) ;
183 BEGIN (#AMENDFILE#)
184   REPEAT
185     REPEAT
186       WRITE ('RECORD NUMBER -->') ;
187       READLN (NUM) ;
188       UNTIL (NUM > 0) AND (NUM <= TOTNUM) ;
189       WITH ITEMNUM DO
190         BEGIN
191           RECMENU ;
192           READLN (FIELD) ;
193           IF (FIELD > 6) OR (FIELD < 0) THEN FIELD := 0 ;
194           CASE FIELD OF
195             0 : NCHANGE ;
196             1 : NAMECHANGE ;
197             2 : PRICECHANGE ;
198             3 : TOTCHANGE ;
199             4 : SOLDCHANGE ;

```

hand. This makes it impossible to write a record into the middle of a file.

PROGRAM BIGTILL in Box 5 is an expanded version of FIRSTILL. In FIRSTILL the data was input at the beginning of each program run. This may be acceptable for a shop that sells five items, but for one that sells fifty it would be a tedious and time consuming process. BIGTILL differs from FIRSTILL in that the records are held on disc in a file (called RECORDS.DATA), loaded into memory at the start of each day's transactions and copied back at the end of each day. Throughout the day the records are held in memory in array ITEM.

In FIRSTILL, PROCEDURE SUMMARY produced the day's results. In BIGTILL results are produced weekly by PROCEDURE WEEK (lines 106 through 122). As it's important to know what should be in the till at the end of each day PROCEDURE DAYSTILL (lines 98 through 104) is provided. DAYTOTAL (line 225) and DAYTAX (line 226) keep tabs of the shop's money and the government's money respectively.

Upon starting up the execution of the program the user is asked if there is an old file (line 227). If the answer is yes, PROCEDURE SETUP (lines 19 through 32) opens the file (line 23) and gets the first record. Note that RESET takes two parameters — the identifier STOCKFILE and the string RECORDS.DATA (which actually appears in the system directory). The second parameter is required by UCSD PASCAL and is not required in standard PASCAL. In lines 24 through 29 each record is read, one at a time, from the STOCKFILE into ITEM. The loop is terminated when the End of File marker is hit (line 14). Line 30 contains another reserved word, CLOSE, that is needed only in UCSD PASCAL. In this version of PASCAL files must be closed before the next RESET or REWRITE can occur. CLOSE(X) deletes X as well as closing it while CLOSE(X, LOCK) retains X in the directory.

If the user does not have a file, then PROCEDURE INITIALISE (lines 34 through 59) is called. In line 39 the STOCKFILE is opened for writing. (Note that RECORDS.DATA is only needed by UCSD PASCAL.) For each record, the FOR DO loop (lines 40-56) reads each field into a record STOCKFILE and then writes this record (line 55) to STOCKFILE. Since this process does not put the information into ITEM it is necessary to call SETUP (line 58) to read the new discfile into memory.

PROCEDURE WRITEFILE (lines 61 through 71) opens the STOCKFILE for writing (line 64) and then in the FOR DO loop (lines 65 through 69) assigns each element of the array ITEM into the file window STOCKFILE so that it can be written to the file (line 68). In fact, line 67 (and line 26) shows one of the major advantages of having a record data structure. Assignment of one record to another of the same type can be done in a single statement. This is true even if the fields of the record contain records, sets and arrays.

PROCEDURE AMENDFILE (lines 124 through 209) allows the user to alter any of the information in array

```

200           S : ORDERCHANGE :
201           A : WRITECHANGE
202           END (*CASE*)
203
204           END (*WITH*) :
205           WRITE (*MORE CHANGES, TYPE Y OR N -->*) :
206           READLN (*CONT*)
207           UNTIL CONT = 'N' :
208           WRITEFILE (*NOT ESSENTIAL BUT DONE TO MINIMIZE EFFECTS OF A SYSTEM CRASH!*)
209           END : (*AMENDED FILE*)
210
211           PROCEDURE HELP :
212           BEGIN
213             PAGE (OUTPUT) :
214             WRITELN (*TYPE H TO SEE THIS DISPLAY :*) :
215             WRITELN (* T TO PRODUCE A TILL SLIP :*) :
216             WRITELN (* D TO PRODUCE THE DAY'S TILL TOTALS :*) :
217             WRITELN (* W TO PRODUCE A SUMMARY OF THE MEEPS'S SALES :*) :
218             WRITELN (* E TO EXIT FROM THIS PROGRAM :*) :
219             WRITELN (* A TO ALTER THE STOCKFILE :*) :
220             READLN
221             END : (*HELP*)
222
223           BEGIN (*MAIN PROGRAM*)
224             ACCEPTABLE := ('A', 'D', 'E', 'H', 'W', 'T') :
225             DAYTOTAL := 0 :
226             DAYTAX := 0 :
227             WRITE (*DOES A FILE ALREADY EXIST, TYPE Y OR N -->*) :
228             READLN (OLD) :
229             IF OLD = 'Y'
230               THEN SETUP
231             ELSE INITIALISE :
232             WRITELN (*TYPE H FOR HELP. :*) :
233             REPEAT
234               READLN (ANSWER) :
235               IF NOT (ANSWER IN ACCEPTABLE) THEN ANSWER := 'H' :
236               CASE ANSWER OF
237                 'A' : APPENDFILE :
238                 'D' : DAYSTILL :
239                 'E' : BEGIN WRITEFILE : WRITELN (*GOOD BYE :*) : END :
240                 'H' : HELP :
241                 'T' : TILLSLIP :
242                 'W' : WEEK :
243                 END (*CASE*) :
244             UNTIL ANSWER = 'E'
245           END .

```

```

1 PROCEDURE TILLSLIP :
2   VAR TOTAL : TAX : REAL :
3       NUM : INTEGER :
4   BEGIN
5     TOTAL := 0 :
6     TAX := 0 :
7     READLN (NUM) :
8     WHILE NUM > -1 DO
9       BEGIN
10        SEEK (STOCKFILE, NUM) :
11        GET (STOCKFILE) :
12        WITH STOCKFILE DO
13          BEGIN
14            WRITELN (NAME,           , PRICE) :
15            QUANTITY SOLD := QUANTITY SOLD + :
16            TOTQUANTITY := TOTQUANTITY + 1 :
17            TOTAL := TOTAL + PRICE :
18            TAX := TAX + (QUANT *
19              SEEK (STOCKFILE, NUM) :
20              PUT (STOCKFILE) :
21              READLN (NUM)
22            END (*WITH*) :
23          END
24        END : (*TILLSLIP*)

```

Look up table

Computer jargon
File-handling
Sequential File
Direct Access File
Records
Fields
Master File
File window — Buffer Variable
Update
Packing
Peripheral
Default

PASCAL Reserved Words
RECORD
WITH — DO
FILE — OF
RESET
REWRITE
GET
PUT
EOF

UCSD Exceptions
See Sections 3 & 4
SEEK
CLOSE

Exercises

- Rewrite FIRSTTILL using WITH
- Rewrite BIGTILL using SEEK

ITEM. This allows for the correction of mistakes made, as well as for changing the stockfile levels when stock comes into the shop or "walks". In line 208 PROCEDURE WRITEFILE is called to make the changes permanent. It isn't essential to do this, since before exiting from the program for the day, the file is written to disc (line 239); it's a precaution to prevent the loss of data if the system crashes.

Compared with handling ordinary variables, the business of file-accessing is clearly rather awkward in programming terms. In particular, where large files of textual materials are concerned, PASCAL supports a number of specialized features. These will be dealt with in our subsequent chapter on word-processing.

Direct Access file handling

Up to this section all the examples have dealt with sets of data that could be completely held in main memory while processing occurred. With memory prices decreasing generally and the new 16-bit micros with their enormous address spaces coming on the market, many applications will actually be able to keep their data in main memory in this way. However, if one isn't planning to purchase a Z8000 with a megabyte

of RAM there probably will come a time when the amount of data required is too large for the memory available. In this case files are kept on disc (or tape) and only the record currently being processed will be in memory. As access speeds on disc are very much slower than those of main memory, every effort has to be made to minimize access time.

When data is held in main memory, the data can be updated during each transaction. When the data is held in sequential files, however, such alteration is more complicated. The file must be copied over into a new file, one record at a time. When the record to be altered is reached, it is brought into memory, amended and then written out into the new file. The rest of the file is then transferred as before. Although this technique ensures that the data being accessed is always up-to-date, the delay between transactions would be of the order of minutes for any reasonably sized file. In consequence, sequential files are not usually updated in this way. Instead, a *secondary* file with the update information is established and all alterations over some period (e.g. a day) are collected. At the end of the period the *master* file is updated. Unfortunately, as this period drags on, the master file becomes progressively more inaccurate and in some applications (e.g. airline reservation systems) such out-of-date information is completely unacceptable, although in our till program, the name, price and VAT rating of the stock are likely to be constant over longer periods of time.

If PASCAL is to become acceptable as a viable language for data processing, it will have to offer the more convenient direct-access facilities associated with disc-based backing store rather than the current standard tape-based sequential access methods. We hope that the standards bodies currently working on PASCAL will take this into account. In the meantime we have taken the liberty of discussing the UCSD implementation of these features which, although non-standard, are widely available on micros.

SEEK is a UCSD reserved word that will search out an individual record from a disc file. SEEK requires two parameters, the first being the file identifier, and the second, an integer representing the record number to which the window must be moved. The first record of a UCSD direct-access file is number 0.

If STOCKFILE in program BIGTILL became so large that the internal array ITEM could not fit into the available memory, several changes would be necessary in the program. Since only one record would be present in memory, the array ITEM would become superfluous. Procedure TILLSLIP in BOX 6 is a rewrite of the version in Box 6. Line 10 locates the required record while line 11 reads it into the window STOCKFILE[^]. STOCKFILE in line 12 corresponds to ITEM[NUM] of line 81 Box 5. After the information has been accessed and altered (lines 14-18) the amended record is copied back into STOCKFILE. Line 19 is necessary because a GET moves the window forward one record, so that PUT in line 20 would otherwise overwrite the (NUM + 1)th record rather

than the NUMH.

Exercise: Re-write BIGTILL for a direct access master file.

Conclusion

Different methods of file-access and their relation to the different media on

which the information is stored have been discussed. It would be misleading to pretend that "normal" data processing programs are as trivial as the examples we have discussed, but we hope that they have been sufficiently realistic at least to illustrate the concepts invol-

ved.

Finally, our thanks to Equinox Computer Systems for the loan of a 56K Horizon with UCSD PASCAL - on which we tested the programs.

Bookfare cont. from p55

but only after discussing various options, so that the reader is given the information on which to make a sensible choice.

Brown's apt and witty style enables him to emphasize the importance of the "boring" but vital elements of compiler writing, like a considerate, user-friendly interface, good documentation and adequate standards. He does this in a way which cannot be ignored and cannot be dismissed as worthy but irrelevant doctrine.

Most of the deadly sins relate to thoughtlessness in providing suitable user facilities: do not treat error diagnosis as an afterthought and do not leave users to find the errors in your compiler, are sins number 5 and 13, and the eleventh and perhaps most deadly one is "to rate the beauty of mathematics above the usability of your computer". The deadly sins are used as landmarks and reminders to help the reader follow Brown's coherent and

comprehensive description of the main aspects of compiler techniques.

Brown's excellent book casts a shadow over another book which has been published recently, one which sets out to perform a similar function - Richard Bornat's *Understanding and Writing Compilers*.

Although the dustjacket claims that computer hobbyists will find Bornat's book "of interest", it is far too academic and heavy going in comparison to Brown's work. Bornat goes into greater detail than Brown into compiler writing techniques and his book is orientated to languages like Algol 68 and Pascal.

I read Bornat after Brown, which is a useful sequence for somebody wishing to explore Brown's insights further. But the legibility of Bornat's text is hampered by the fact that it has been typeset using a Diablo printer which I found a strain and added to my feeling of dense concentration of information, in comparison to Brown's souffle.

Eine kleine byte musik

One of the first applications of digital program control was the music-roll pianolas or "reproducing piano player". That was in the 1920s, long before the first expensive fiddling about with computer music in the 1950s and 60s and the more recent micro music explosion.

The Byte Book of Computer Music provides an interesting and illuminating survey of the scope and practicality of computer music. Its seventeen articles range from a look at those early reproducing pianos through to an assortment of music chips, Fourier Transforms and a \$19 music interface. There is also a trip to the musical fringes of the 20th Century with a program which translates contour maps into music.

Most of the articles first appeared in *Byte* magazine. In the last few years but six have been specially commis-

sioned, including ones on singing KIMs and musical Altair 8800s.

There is plenty in the book to stir the imagination and to give practical hints to what the book's editor Christopher Morgan, calls the "new generation of music enthusiasts, would-be musicologists and fugue fanciers" who are sampling the "delights of digital music synthesis."

Books discussed in this month's Bookfare have been *Running Wild* by Adam Osborne (Osborne/McGraw-Hill, £2.95)

Writing Interactive Compilers and Interpreters by P.J. Brown (John Wiley & Sons, £9.75)

Understanding and Writing Compilers by Richard Bornat (Macmillan, £5.95 paperback, £12.00 hard cover)

The Byte Book of Computer Music edited by Christopher P. Morgan (Byte Books, £6.75 - available from LP Enterprises)

CHECKOUT VIDEO GENIE

A Video Genie materialized at PCW recently - courtesy of Lowe Electronics; Z-80 based, it's fully compatible with the TRS-80 level II. The machine, an integral processor, keyboard and cassette drive, plugs into the domestic TV and is no bad way of "getting into" computing.



It has a socket for attachment of an external cassette, quite useful if you encounter load problems, as I did. It seems that some of the commercially available tapes, while being suitable for the TRS-80, need some means of volume adjustment on the Genie.

We lent the machine to Ian O'Neill (who has used a TRS-80 for some time now) to see what he thought of it. Here are some of his comments:

"The built-in cassette recorder

worked well and cut down the number of leads needed to connect the system to the mains and to other units. It also offered a manual/computer control switch, ideal for rewinding etc. All the TRS-80 programs from my own system loaded perfectly, both on the internal cassette and on an externally connected one. I also liked the built-in power supply."

One or two things are worth mentioning in addition to Ian's comments. It has a double width character switch which stretches the characters that appear on the screen, thus making editing much less of a strain on the eyes. There is a reset button tucked away behind the keyboard which resets the machine when and if it locks. This can happen if reading a poorly recorded tape for example. Finally, the \$100 bus ensures compatibility with a wide range of peripheral devices. Returning to Ian's comments, he also noticed a few things that he didn't like:

"The monitor I used had a severe attack of the shakes when attached to the Genie, and I also failed to get it to work with either of our domestic televisions. It seems that I should have tuned them in, something I didn't realise at the time. Perhaps the instructions could be clarified. I found the convention of calling the return key "new line" repulsive - I don't know why, I even prefer 'enter'. Ah well, it's not that important I suppose. One fairly serious omission from the keyboard was a 'clear' key; and, despite the assurances of the sales blurb, I could find no justification for the claim of 'full cursor controls'; there is only backspace and new line.

The manuals, although first attempts, appear sufficient and are pro-

bably easier on the inexperienced owner than the detailed, though excellent, TRS-80 Level II manual. The literature seems to have been written with the American user in mind and hence it is over-simplified in places and littered with bad grammar and American spelling.

"The BASIC is very compatible with that of the TRS-80 as is shown by the benchmark timings (in seconds), which are as follows:

BM1: 2.7, BM2: 11.6, BM3: 28.0, BM4: 28.5, BM5: 31.3, BM6: 51.9, BM7: 81.0, BM8: 11.7

One final thing - numeric keypad freaks will be sorry to hear that there is no convenient place on the Video Genie to fit a keypad, as there is on a TRS-80. This is not a major disadvantage, however, as these devices are mainly a "keeping up with the PETs' gimmick."

Our view of the system is that it is an economical way of "getting into" personal computing. Its main disadvantage is that if you use the family telly, as I do, then either the family has to prefer watching you playing with the computer or your computing time will be severely curtailed in the interests of domestic harmony. - David Tebbutt

TECHNICAL DATA

CPU	Z80
Memory	16K RAM
Screen	Own television or monitor 64 or 32 characters per line
Cassettes	Integral or own domestic connected through DIN connector
Bus	\$100
Ports	Up to 256 through expansion box
Languages	TRS-80 Level II compatible

TRANSAM

COMPONENTS AND SOFTWARE FROM TRANSCOM COMPUTERS

*CP/M
*BASIC
*PASCAL



"TRITON IS IMPRESSIVE"
PRACTICAL COMPUTING REVIEW DEC 79

TRITON COMPUTER SYSTEM

DESIGNED FOR EASE OF CONSTRUCTION AND FLEXIBILITY KITS COME COMPLETE AND ALL COMPONENTS AND SOFTWARE ARE AVAILABLE SEPARATELY UK DESIGNED AND SUPPORTED FULLY DOCUMENTED HARDWARE AND SOFTWARE AND A "TOTAL CLEARANCE APPROACH" TO SYSTEM BUILDING POWERFUL AND EASY TO USE SYSTEM MONITORS - A RANGE OF LANGUAGES AVAILABLE - FIRMWARE IS EPROM BASED AND UPGRADING FROM ONE LEVEL TO THE NEXT IS EASY

L41 WITH 1k MONITOR 2k BASIC £796
L61 WITH 1k MONITOR 7k BASIC £399
L71 WITH 2k MONITOR
8k EXTENDED BASIC £409
L81 ED ROM 20k 8k PASCAL £619
L81 CP/M DISC BASED SYSTEM £734
8k RAM CARD KIT (214k) £37
% EPROM CARDS (EXCL 8k270) £31
MOTHERBOARD EXPANSION 8 SLOT £50
% EPROM CARDS (EXCL 8k270) £31
TRANSAM 8080 DRUM PRINTER £76
TRITON VIDEO MONITOR 9" £399
EPROM PROG KIT £29.90
SEND FOR OUR CATALOGUE FOR FULL DETAILS OF TRITON FEATURES!

CRYSTALS	5MHz	2.70	Z80A	15.00	
100K	3.00	2.70	8085A	12.50	
200K	3.70	2.70	8502	6.00	
1MHz	7.50	2.50	501P	10.00	
1008K	3.50	80Hz	2.70	6802	13.95
1043K	3.00	10MHz	2.70		
2MHz	1.80	7.10			
2457K	3.65	F81850	9.50		
3276K	2.70	8085A	6.33		
445K	2.10	6800	24.00		
4.43M	1.80	Z80	8.00		

AVAILABLE NOW FOR TRITON

CP/M OPERATING SYSTEM COMPLETE WITH TEXT EDITOR, ASSEMBLER, DEBUGGER, SYSTEM UTILITIES AND COMPLETE FILE MANAGEMENT. MAKES TRITON FULLY CP/M COMPATIBLE AND ABLE TO RUN CP/M BASED SOFTWARE. TRITON WILL SUPPORT UP TO FOUR 5 1/4" 8" DRIVES SINGLE OR DOUBLE DENSITY FULL CP/M SOFTWARE USER GROUP FACILITIES AVAILABLE. S.A.E. FOR DETAILS.

DISC DRIVES & POWER SUPPLIES

SHUGART	S4400	5 1/4" DRIVE	£205.00
	SAB800	8" DRIVE	£300.00
		POWER ONE QUALITY POWER SUPPLIES	
	CP240	240W PSU	£330.00
	CP252	245W PSU	£60.00
	CP205	205W PSU	£55.00
	CP206	206W PSU	£76.00

FULL RANGE OF MICRO SUPPORT CHIPS IN STOCK

SN74LS00N	22	SN74LS04N	21	SN74LS158N	95	SN74LS184AN	85	SN74LS325N	255
SN74LS01N	22	SN74LS05N	21	SN74LS159N	95	SN74LS185N	720	SN74LS326N	255
SN74LS02N	22	SN74LS06N	50	SN74LS164N	120	SN74LS187N	120	SN74LS327N	255
SN74LS03N	26	SN74LS07N	35	SN74LS165N	175	SN74LS221N	120	SN74LS328N	135
SN74LS04N	26	SN74LS10N	85	SN74LS166N	175	SN74LS222N	120	SN74LS329N	135
SN74LS05N	26	SN74LS11N	46	SN74LS167N	60	SN74LS243N	1.95	SN74LS354N	1.50
SN74LS06N	26	SN74LS12N	35	SN74LS168N	180	SN74LS244N	1.95	SN74LS355N	1.50
SN74LS07N	22	SN74LS13N	35	SN74LS169N	175	SN74LS245N	1.95	SN74LS356N	1.50
SN74LS08N	18	SN74LS14N	1.15	SN74LS170N	125	SN74LS246N	2.10	SN74LS357N	1.50
SN74LS09N	18	SN74LS15N	1.15	SN74LS171N	125	SN74LS247N	2.10	SN74LS358N	1.50
SN74LS10N	22	SN74LS16N	40	SN74LS172N	115	SN74LS248N	1.95	SN74LS359N	1.50
SN74LS11N	22	SN74LS17N	1.15	SN74LS173N	115	SN74LS249N	1.95	SN74LS360N	1.50
SN74LS12N	22	SN74LS18N	40	SN74LS174N	115	SN74LS250N	1.95	SN74LS361N	1.50
SN74LS13N	22	SN74LS19N	40	SN74LS175N	115	SN74LS251N	1.95	SN74LS362N	1.50
SN74LS14N	22	SN74LS20N	40	SN74LS176N	115	SN74LS252N	1.95	SN74LS363N	1.50
SN74LS15N	22	SN74LS21N	40	SN74LS177N	115	SN74LS253N	1.95	SN74LS364N	1.50
SN74LS16N	22	SN74LS22N	40	SN74LS178N	115	SN74LS254N	1.95	SN74LS365N	1.50
SN74LS17N	22	SN74LS23N	40	SN74LS179N	115	SN74LS255N	1.95	SN74LS366N	1.50
SN74LS18N	22	SN74LS24N	40	SN74LS180N	115	SN74LS256N	1.95	SN74LS367N	1.50
SN74LS19N	22	SN74LS25N	40	SN74LS181N	115	SN74LS257N	1.95	SN74LS368N	1.50
SN74LS20N	22	SN74LS26N	40	SN74LS182N	115	SN74LS258N	1.95	SN74LS369N	1.50
SN74LS21N	22	SN74LS27N	40	SN74LS183N	115	SN74LS259N	1.95	SN74LS370N	1.50
SN74LS22N	22	SN74LS28N	40	SN74LS184N	115	SN74LS260N	1.95	SN74LS371N	1.50
SN74LS23N	22	SN74LS29N	40	SN74LS185N	115	SN74LS261N	1.95	SN74LS372N	1.50
SN74LS24N	22	SN74LS30N	40	SN74LS186N	115	SN74LS262N	1.95	SN74LS373N	1.50
SN74LS25N	22	SN74LS31N	40	SN74LS187N	115	SN74LS263N	1.95	SN74LS374N	1.50
SN74LS26N	22	SN74LS32N	40	SN74LS188N	115	SN74LS264N	1.95	SN74LS375N	1.50
SN74LS27N	22	SN74LS33N	40	SN74LS189N	115	SN74LS265N	1.95	SN74LS376N	1.50
SN74LS28N	22	SN74LS34N	40	SN74LS190N	115	SN74LS266N	1.95	SN74LS377N	1.50
SN74LS29N	22	SN74LS35N	40	SN74LS191N	115	SN74LS267N	1.95	SN74LS378N	1.50
SN74LS30N	22	SN74LS36N	40	SN74LS192N	115	SN74LS268N	1.95	SN74LS379N	1.50
SN74LS31N	22	SN74LS37N	40	SN74LS193N	115	SN74LS269N	1.95	SN74LS380N	1.50
SN74LS32N	22	SN74LS38N	40	SN74LS194N	115	SN74LS270N	1.95	SN74LS381N	1.50
SN74LS33N	22	SN74LS39N	40	SN74LS195N	115	SN74LS271N	1.95	SN74LS382N	1.50
SN74LS34N	22	SN74LS40N	40	SN74LS196N	115	SN74LS272N	1.95	SN74LS383N	1.50
SN74LS35N	22			SN74LS197N	115	SN74LS273N	1.95	SN74LS384N	1.50
SN74LS36N	22			SN74LS198N	115	SN74LS274N	1.95	SN74LS385N	1.50
SN74LS37N	22			SN74LS199N	115	SN74LS275N	1.95	SN74LS386N	1.50
SN74LS38N	22			SN74LS200N	115	SN74LS276N	1.95	SN74LS387N	1.50
SN74LS39N	22			SN74LS201N	115	SN74LS277N	1.95	SN74LS388N	1.50
SN74LS40N	22			SN74LS202N	115	SN74LS278N	1.95	SN74LS389N	1.50
SN74LS41N	22			SN74LS203N	115	SN74LS279N	1.95	SN74LS390N	1.50
SN74LS42N	22			SN74LS204N	115	SN74LS280N	1.95	SN74LS391N	1.50
SN74LS43N	22			SN74LS205N	115	SN74LS281N	1.95	SN74LS392N	1.50
SN74LS44N	22			SN74LS206N	115	SN74LS282N	1.95	SN74LS393N	1.50
SN74LS45N	22			SN74LS207N	115	SN74LS283N	1.95	SN74LS394N	1.50
SN74LS46N	22			SN74LS208N	115	SN74LS284N	1.95	SN74LS395N	1.50
SN74LS47N	22			SN74LS209N	115	SN74LS285N	1.95	SN74LS396N	1.50
SN74LS48N	22			SN74LS210N	115	SN74LS286N	1.95	SN74LS397N	1.50
SN74LS49N	22			SN74LS211N	115	SN74LS287N	1.95	SN74LS398N	1.50
SN74LS50N	22			SN74LS212N	115	SN74LS288N	1.95	SN74LS399N	1.50
SN74LS51N	22			SN74LS213N	115	SN74LS289N	1.95	SN74LS400N	1.50
SN74LS52N	22			SN74LS214N	115	SN74LS290N	1.95		
SN74LS53N	22			SN74LS215N	115	SN74LS291N	1.95		
SN74LS54N	22			SN74LS216N	115	SN74LS292N	1.95		
SN74LS55N	22			SN74LS217N	115	SN74LS293N	1.95		
SN74LS56N	22			SN74LS218N	115	SN74LS294N	1.95		
SN74LS57N	22			SN74LS219N	115	SN74LS295N	1.95		
SN74LS58N	22			SN74LS220N	115	SN74LS296N	1.95		
SN74LS59N	22			SN74LS221N	115	SN74LS297N	1.95		
SN74LS60N	22			SN74LS222N	115	SN74LS298N	1.95		
SN74LS61N	22			SN74LS223N	115	SN74LS299N	1.95		
SN74LS62N	22			SN74LS224N	115	SN74LS300N	1.95		
SN74LS63N	22			SN74LS225N	115	SN74LS301N	1.95		
SN74LS64N	22			SN74LS226N	115	SN74LS302N	1.95		
SN74LS65N	22			SN74LS227N	115	SN74LS303N	1.95		
SN74LS66N	22			SN74LS228N	115	SN74LS304N	1.95		
SN74LS67N	22			SN74LS229N	115	SN74LS305N	1.95		
SN74LS68N	22			SN74LS230N	115	SN74LS306N	1.95		
SN74LS69N	22			SN74LS231N	115	SN74LS307N	1.95		
SN74LS70N	22			SN74LS232N	115	SN74LS308N	1.95		
SN74LS71N	22			SN74LS233N	115	SN74LS309N	1.95		
SN74LS72N	22			SN74LS234N	115	SN74LS310N	1.95		
SN74LS73N	22			SN74LS235N	115	SN74LS311N	1.95		
SN74LS74N	22			SN74LS236N	115	SN74LS312N	1.95		
SN74LS75N	22			SN74LS237N	115	SN74LS313N	1.95		
SN74LS76N	22			SN74LS238N	115	SN74LS314N	1.95		
SN74LS77N	22			SN74LS239N	115	SN74LS315N	1.95		
SN74LS78N	22			SN74LS240N	115	SN74LS316N	1.95		
SN74LS79N	22			SN74LS241N	115	SN74LS317N	1.95		
SN74LS80N	22			SN74LS242N	115	SN74LS318N	1.95		
SN74LS81N	22			SN74LS243N	115	SN74LS319N	1.95		
SN74LS82N	22			SN74LS244N	115	SN74LS320N	1.95		
SN74LS83N	22			SN74LS245N	115	SN74LS321N	1.95		
SN74LS84N	22			SN74LS246N	115	SN74LS322N	1.95		
SN74LS85N	22			SN74LS247N	115	SN74LS323N	1.95		
SN74LS86N	22			SN74LS248N	115	SN74LS324N	1.95		
SN74LS87N	22			SN74LS249N	115	SN74LS325N	1.95		
SN74LS88N	22			SN74LS250N	115	SN74LS326N	1.95		
SN74LS89N	22			SN74LS251N	115	SN74LS327N	1.95		
SN74LS90N	22			SN74LS252N	115	SN74LS328N	1.95		
SN74LS91N	22			SN74LS253N	115	SN74LS329N	1.95		
SN74LS92N	22			SN74LS254N	115	SN74LS330N	1.95		
SN74LS93N	22			SN74LS255N	115	SN74LS331N	1.95		
SN74LS94N	22			SN74LS256N	115	SN74LS332N	1.95		
SN74LS95N	22			SN74LS257N	115	SN74LS333N	1.95		
SN74LS96N	22			SN74LS258N	115	SN74LS334N	1.95		
SN74LS97N	22			SN74LS25					

YOUNG COMPUTER WORLD

Young Computer World is the place where, each month, John Coll highlights the thoughts, ideas and contributions of PCW's younger readers.

I'm afraid that I don't have access to an ACORN but it does look like a rather well designed machine. I'd be interested to hear from anyone who has written other programs for it.

Expression Input

Last September I asked for suggestions for getting an equation into a running BASIC program. The only general solution that emerged was that the file should be saved with the equation in it and then that the new file should be CHAINED in. Even using this technique there are several variations, like these: Chris Wilkinson of Eastbourne suggests the following:

```

10 PRINT "INPUT YOUR EXPRESSION"
20 INPUT E$
30 PUT "PROGB",*10;E$
40 PUT "PROGB",*20 CHAIN PROGA,100"
50 CLOSE "PROGB"
60 CHAIN "PROGB"
100 REM CONTINUE PROGA
    
```

J. J. Marten of Chelmsford suggested the following variation, in PDP-11 BASIC:

```

10 PRINT "INPUT YOUR EXPRESSION"
20 INPUT E$
30 OPEN "FUNCT" FOR OUTPUT AS FILE #1
40 PRINT #1:"100 DEF FNY(X)=";E$
50 CLOSE #1
60 OVERLAY "FUNCT"
100 REM CONTINUE PROGRAM WITH NEW LINE 100
    
```

Joshua Danziger of Whitfield, Manchester suggests the following for a SYSTIME 3000 running RSTS 11;

```

1000 ON ERK08 GOTO 2000
1010 OPEN "GRAB12.BAS" FOR INPUT AS FILE 15
1020 OPEN "TEMP.FILE" FOR OUTPUT AS FILE 25
1030 INPUT "EXPRESSION IN TERMS OF *E$ "
1040 E$="1000" *E$
1050 WRT5,15
1060 INPUT LINE P15,L15
1070 WRT5,15
1080 CLOSE L15,P15
1090 KILL "GRAB12.BAS"
1100 NAME "TEMP.FILE" AS "GRAB12.BAS"
1110 OPEN "GRAB12.BAS"
1200 IF E$=1000 THEN RESUME 1050 ELSE ON ERK08 GOTO
    
```

It certainly is hard work isn't it!

Jobs

I've had about 25 replies from people looking for jobs and have managed to place a few of those, I am glad to say. I will keep my eyes open for other companies looking for young people and will continue to pass on details to companies. Please don't ask me to send "full details of the jobs available" because most of the jobs go almost immediately and anyway the companies concerned often make the job match the person rather than the other way round - which is rather nice.

380Z programs

I am on the scrounge for some really good programs for the R. M. 380Z - both games with good graphics and "useful" programs - again using graphics wherever possible. I would like to receive these on cassette or disc so as an inducement I will send a free copy of the next month's PCW to anyone who sends in a cassette program (I keep the cassette!) or I will send a free copy of PCW and return your disc. In a few months time this page should be packed with 380Z programs (remember how long it takes to get things into print). I'll tell you later why I am on the scrounge.

Help

As usual please send stuff in that you would like to see published. It can be a program, an electronic design or your suggestions and comments on some equipment, service or software. My address is Laxton House, Oundle, Peterborough. Thanks.

PETs and tanks

Lastly, Kevin Jones (13) of Lytham St Annes has, with the aid of his father, produced a Tank Battle simulation for the PET. He tells me that it will work in a 4K PET if all the REMs are removed and it will work in both new and old ROM PETS. The game takes place across a minefield, with the additional hazard of walls to negotiate. The game is for two players, each equipped with a tank, and the first to score ten points wins. A point is scored by hitting your opponent's tank with a missile. Each player has 9 controls arranged in a 3 by 3 square. Though the game was written for a PET it should be fairly easy to adapt. The PET's instruction POKE 32768+40*Y+X,Z is equivalent to PLOT X,Y,Z on other machines.

The listing is in the "Programs" section.



Well I have sorted out last month's mail and am ready to tell you about both the letters I have received!! It's not quite that bad but clearly the end of term (I am writing this just before Christmas) is not the best time for sending in programs and articles.

It's interesting to see the different styles of contributors. On the one hand there are the programs by thirteen year olds that arrive accompanied by an immaculately typed letter, on the other hand there are short programs by fifteen year olds neatly written out on scraps of paper! I strongly prefer the latter, where there has been rather less adult influence! People often think that you have to spend hours writing an article - not so. A good idea can be jotted down in a few minutes and it really doesn't matter how perfect the typing is. By the time I have knocked it around and Dave Tebbutt (the Technical Editor) has topped and tailed my offering, it's often only the idea and the actual program that survive.

Acorns

Paul Durrant (15) of Norwich has sent in a small machine code program for the ACORN that verifies that a cassette program has loaded into memory correctly. The program itself fits into the upper 48 bytes of RAM in the INS154 I/O chip (B1). To use the routine one sets up the address OED0 on the ACORN, starts the tape and presses the GO key. After a few seconds a message will appear (either ERROR or FINE) and the program will return you to the monitor.

Address	Op-code	Label	Mnemonic	Comments
0ED0	A204	VRJFT	LDR#4	LOAD COUNTER
0ED2	20D0FE	LDAOR	JSR GETYTE	FIND ADDRESS
0ED5	9505		STAZ, X 95	STORE IN PAP AND TAP
0ED7	C1		DEX	DECREMENT COUNTER
0ED8	D0F8		BNE LDAOR	X ZERO ON EXIT
0EDA	20D0FE	CONPRG	JSR GETYTE	GET BYTE FROM TAPE
0EDC	C105		CHP (D5, E)	COMPARE WITH MEMORY
0EDF	D0F7		BNE ERK08	ERR08?
0EE1	20A0FE		JSR COM16	NO, INCREMENT ADDRESS
0EE4	D0F3		BNE CONPRG	KEEP ON GOING
0EE6	A003		LDW#D3	ALL OK SO T1#5
0EE8	A204	ERR08	LDR#04	ERR08 DO 4 REMAINS 0
0EEA	8F#ADE	MESSAGE	LDA#1,DATA1	READ MESSAGE FROM DATA
0EED	9510		STAZ, XD	AND PUT ON DISPLAY
0EEF	88		DET	DECREMENT DATA INDEX
0E90	CA		DEX	AND SCREEN POSITION
0E91	10F7		BPL MESSAGE	CONTINUE WITH MESSAGE
0E93	#CD0FF		J#P RESTART	RETURN TO MONITOR
0E96	7955D0	DATA	'E' 'B' 'B'	
0E99	5C50		'D' 'B'	'ERR08'
0E9B	00710A	DATA1	' ' 'F' 'I'	
0E9E	5479		'N' 'E'	'FINE'

Britain's most up-to-date and comprehensive guide to the selection of microcomputer equipment, compiled for PCW by Richard Olney of Heuristic Consultants.

Machine (Price from)	Main Distributor/s (No. of dealers)	Hardware	Software	Documen- tation	Miscellaneous
ABC 80 (£790)	CCS Microsales: 01-444 7739 (TBA)	16-40K RAM: Z80A: C: 12" 16x40 b&w VDU: 4680 bus: IEEE 488: RS232 port: option — dual 5 1/4" F/D (160K, own DOS), £895	DOS: BASIC: games: W/P: <i>DataBase: En- gineering & construction prog</i>	S	Graphics loudspeaker with 128 effects: View- data compatible.
ALPHA MICRO (£5,700)	Alpha Micro Systems UK Ltd: 01-930 1991 (TBA)	64K-16M RAM: W/L 16 bits: Dual 8" F/D (1.2MB): 6 S/P: 12"	multi-user O/S: E BASIC: M/A: PASCAL: T/E: U: B/P	E	Expands to 1200 MB, 32 terminal system: average 10MB H/D system — £1,100
APPLE II (£810)	Microsense: 0442 63561 (80+)	16-48K RAM: 6502: 8 I/O slots: 15"x18"x5": options — single 5 1/4" F/D (116K), £425; C, £33; RS232 mt, £110; 16K RAM, £110	O/S: BASIC: PASCAL: <i>games</i>	S	280x192 high resolution graphics: integer BASIC in 6K ROM
ALTOS ACS 8000 (£3,398)	Logitek: 02572 66803 (TBA)	64K RAM: Z80: 1K ROM: dual 8" F/D (1MB): 2 RS232: 1 P/P	CP/M: BASIC: <i>FORTRAN: COBOL: PASCAL: M/A: W/P: B/P</i>	S&H	Extensive software support by Interface Software Ltd., of Camberley.
ATTACHE (£7,000)	R. H. Thorpe Ltd: 0276 29492. R. J. Spiers Ltd: 0603 416573 (TBA)	48K RAM: 8080: dual 8" F/D (616K): 9", 16x64 b&w VDU: 180 cps printer	ExBASIC: P/P: <i>FOR- TRAN</i>	S	W/P package available soon
BILLINGS BC-12FD (£4,295)	Mitech: 04862 23131 (TBA)	64K RAM: Z80A: dual 5" F/D (640K): 12" 24x80 b&w VDU: options — 80 col 160 cps printer, £375; 132 col 55cps DM printer, £975	DOS: BASIC: <i>FORTRAN: COBOL: A.</i>	S	Also avail. BC-DF2M with dual 8" F/D (2MB) instead of 5" (£6,000; extra dial 8" F/D, £2,750; with 50MB H/D from £11,000; Graphics.
CBS Mk I (£4,900)	Compelec: 01-636 1392 (n/a)	64K RAM: Z80: dual 8" F/D (1MB): 12", 24x80 VDU: 132 col, 30 cps printer: 2 S/P: 1 P/P: options — 150cps bi-directional printer, £2,000; 55cps W/P printer, £2,000	CP/M: BASIC: W/P: U: B/P	S&H	Mk II available with 2MB F/D, £5,900. Can upgrade to Mk III. Desk mounted.
CBS Mk III (£8,150)	As above	64K RAM: Z80: dual 8" F/D (1MB): 12", 24x80 VDU: 132 col, 30cps printer: 11MB H/D: 6 S/P: 1 P/P: options — 150cps bi-directional printer, £2,000; 55cps W/P printer, £2,000 12". 24x80 VDU, £655.	CP/M: BASIC: W/P: U: B/P	S&H	Up to 44MB H/D possible, £4,500 extra. Multi- user system with 280K RAM, £10,150.
CHALLENGER — 1P (£238)	Mutek: 0225 743289 1414. CTS: 0706 79332 U-Microcomputers: 0606 853390 Microcomputer Business Machines: 01-980 3993 Byte Shop: 01-518 Millbank Computing 01-549 7262	4-32K RAM: 6502: C int: RS232 port: 15"x16"x4" option — dual 5 1/4" F/D (160K), £550	O/S: BASIC: A: games: <i>ExBASIC: Data Man: B/P (limited).</i>	S	D/A conv: colour capabili- ty: 8K microsoft BASIC in ROM
CHALLENGER C2 (£404)	As above	4-48K RAM: 6502: C int: RS232 port: 15"x16"x4" options — dual 5 1/4" F/D (160K), £550; dual 8" F/D (1.15MB); 20MB H/D.	O/S: BASIC: A: games: <i>ExBASIC: Data Man: B/P (limited)</i>	S	Can run OSI business software if 8" F/D inc.

List of Abbreviations	C/P Commercial package E Extensive F/D Floppy disc G/C Graphics card H Hardware H/D Hard disc	I Introductory int Interface I/S Indexed sequen- tial K/B Keyboard M/A Macro assembler N/P Numeric pad	O/S Operating system P/P Parallel port S Software S/P Serial port TBA To be announced T/E Text editor T/P Text processor	U Utility W/L Word length W/P Word processor
-----------------------	--	--	--	--

Please note: Software items listed in *italics* are not included in the basic price of the equipment. All prices are *exclusive* of VAT

Machine (Price from)	Main Distributor/s (No. of dealers)	Hardware	Software	Documen- tation	Miscellaneous
CHALLENGER C3 (£2334)	As above	32-56K RAM: 6502, 6800, Z80: dual 8" F/D (1.15MB); 2-16 S/P: 17"x22"x12"	OS65U; BASIC: CP/M FORTRAN COBOL: B/P: W/P: Data Management	S&H	Also C3B & C3P H/D modules: 74MB for about £10,000
COMMA VO3 (£4,200)	Comma: 0277 811131 (n/a)	32K RAM: LSI 11; dual 8" F/D (512K); 4 serial; DLU11S ports: modular	RT1 0/S (£750); BASIC: COBOL: FOR- TRAN: B/P (limited)	H	Many configs possible: about £27,000
COMPELEC SERIES (£2,400)	Compelec: 01-636 1392 (n/a)	64K RAM: Z80: dual 8" F/D (512K): 2 RS232 ports, 1 P/P	CP/M: A: CBASIC: COBOL: FOR- TRAN: PAS- CAL: W/P: B/P	S	Also with double density F/D, 1MB, £2,900; 1K EPROM
COMPU-CORP 625 (£6,000)	Compucorp: 01-952 7860 (15)	60K RAM: Z80: dual 5 1/4" F/D (700K); 9", 16x80 b&w VDU: 40cps printer 1 RS232 port: 20"x28"x10"	A: BASIC: U: W/P: B/P	B	Also available, 655 model with 315K F/D capability & 12" 20x80 VDU — £3,750
COMP WORKSHOP SYSTEM 1 (£1,600)	Comp Workshop: 01-491 7507 (n/a)	32K RAM: dual 5 1/4" F/D (170K); 9", 16x64 b&w VDU: modular	A: BASIC: FORTRAN: FLEX: PAS- CAL: PILOT: B/P	E	These systems are example configs from a fully compatible modular range
COMP WORKSHOP SYSTEM 2 (£11,000)	As above	128K RAM: 6809: dual 8" F/D (1.2MB); 3 intelligent 20x80 terminals; 80 col, 125cps printer: daisy wheel Sprint 3 printer	A: BASIC: FORTRAN: FLEX: PAS- CAL: PILOT: B/P	E	As above
COMP WORKSHOP SYSTEM 3 (£36,000)	As above	768K RAM: 6809: dual 8" F/D (1.2MB); 64MB H/D: 10 intelligent 20x80 terminals: 2 132 col, 120cps printers: 2 80 col, 125cps printers: 2 daisy wheel Sprint 3 printers: max 16 ports.	A: BASIC: FORTRAN: FLEX: PAS- CAL: PILOT: B/P	E	As above
COMPU-COLOUR II (£1,058)	Abacus: 01-580 8841 (6)	8-32K RAM: 8089: 13", 32x64 8-colour VDU: single 5 1/4" F/D (51K); RS232 port: 18"x15"x13"	ExBASIC (ROM); A: personal data bases: games	I	16K module, £1,134; 34K, £1,137; maintenance & programming manual available.
CROMEMCO SYSTEM 2 (£1,995)	Comart: 0480-215005. Datron: 0742-585490. Microcentre: 031-225 2022 (20)	64K RAM: Z80: dual 5 1/4" F/D (180K); options — dual 8" F/D (512K), £1370; 11MB H/D, £3495; 22MB H/D, £5999	CBOS: BASIC: COBOL: FOR- TRAN (£55): multi-user BASIC	E	Expandable to multi-user system (275 users), £3,455-£6,400
CROMEMCO SYSTEM 3 (£2,995) (£4K, £3,293)	As above	32-64K RAM: Z80: dual 8" F/D (512K); options as above: extra dual F/D, £1,200	CBOS: BASIC: COBOL: FOR- TRAN; multi- user BASIC	E	As above
DIGITAL MICROSYSTEM DSC-2 (£5,395)	Modata: 0892 39591 (TBA)	64K RAM: Z80: dual 8" F/D (2.28MB); 4 RS232 ports: EIA port: 17"x21"x7"	CP/M: BASIC: E: CBASIC: COBOL: FOR- TRAN: PAS- CAL: CAP B/P	H	Up to 6 additional F/D units possible
DURANGO (£7,750)	Comp Ancillaries: 07843 6455 (12)	48K RAM: 8085x3: dual 5 1/4" F/D (1MB); 9", 16x64 green VDU: 132 col 165cps printer; N/P: options — add F/D, £1,753; aux VDU £875	O/S: DBASIC: B/P	S	Takes up to 4 workstations: fully integrated system 15"x30"x24"
DYNABYTE DB8/1 (£1,500)	Dynabyte UK/Europe Ltd: 0723 65559 (6)	32-64K RAM: Z80: S100 bus; 2 RS232 ports: 1 P/P: 20"x18"x7"; option — dual 8" F/D (1MB), £2,000	CP/M: BASIC: COBOL: FOR- TRAN: PAS- CAL: W/P: B/P	H	Expands to multi-user system; also DB8/2 with dual 5 1/4" F/D (400K), £3,000
EG 3003 (£378)	Lowe Electronics: 0629 2817 (TBA)	16K RAM: Z80: 500 bps C: 32x64 TV int: extra C int: 1 P/P: K/B	BASIC: M/A: FORTRAN: B/P	I	BASIC in 12K ROM; Graphics available; F/D system under development.
EQUINOX 200 (£9,995)	Equinox: 01-739 2387 (n/a)	64-256K RAM: Z80: 10MB H/D: 15", 24x80 b&w VDU: 15cps printer	CP/M: BASIC: COBOL: FOR- TRAN: MVT/ FAMOS	S&H	
EQUINOX 300 (£11,750)	As above	64-256K RAM: W/L 16 bits: 10MB H/D: 15", 24x80 b&w VDU: 150cps printer: 6 S/P	O/S: BASIC: COBOL: M/A: PASCAL: LISP: SNOBOL: T/P multi-user:	S	Up to 1200MB of storage possible (4x300MB, Calcomp Tridents)

Machine (Price from)	Main Distributor/s (No. of dealers)	Hardware	Software	Documen- tation	Miscellaneous
EUROC (£7,995)	Eurocalc Ltd: 01-405 3113 (TBA)	64K RAM: 8080A: dual 8" F/D (1MB): 15", 25x80 b&w VDU: 132 col, 140cps printer	CP/M: CBASIC: S A: account sys- tem: U: B/P		A year's maintenance and stationary supply inc.
EXIDY SORCERER (£850) (16K, £760; 32K £859)	Liveport Data Products Ltd: 073 670 6320 (27)	8-32K RAM: Z80: RS232: 1 P/P: S100 connector: 30x64 VDU I/O: options — dual 5 1/4" F/D (630K), £1,200; 12", 30x64 green VDU, £240; S100 chassis, £210	O/S: ExBASIC I (ROM): W/P: Editor: A: games		High resolution graphics capability.
H11 Kit (£1,844)	Heath: 0452 29451 (n/a)	LSI 11: 16-32K RAM: 24x80 VDU int: up to 16 S/P or P/P: options — dual 8" F/D (512K), £1,325; 12", 24x80 VDU, £558	O/S: BASIC: S&H FORTRAN: A: games: T/E: U.		CPU and VDU int boards sold as separate items.
HEATH WH89 (£1,380)	As above	16-48K RAM: Z80: single 5 1/4" F/D (102K): 12" 25x80 b&w VDU: RS232: 13"x17"x20": options — 16K RAM, £158	BASIC: A: I W/P: B/P		Cassette available in- stead of F/D, £882; in kit form WH89 is £1,200
IMS 5000 (£1,935)	Equinox: 01-739 2387 (20)	32-64K RAM: Z80: dual 5 1/4" F/D (320K)	CP/M: BASIC: S&H COBOL: FOR- TRAN: PAS- CAL: W/P		3 drives option
IMS 8000 (£3,515)	As above	64-256K RAM: Z80: dual 8" F/D (1MB)	CP/M: BASIC: S&H COBOL: FOR- TRAN: PAS- CAL: W/P: CAP: Micro COBOL: MVT/ FAMOS: multi- user		4 drives optional
IMSAI VDP 42 (£3,900)	Computermart: 0603 615089, Corner Comp: 03727 41101 (2)	32-64K RAM: 8085: dual 5 1/4" F/D (400K): 9" 24x80 b&w VDU: 1 S/P: 1 P/P: 18"x27"x12"	IMDOS (CP/M comp): H A: ExBASIC: U: CBASIC: COBOL: FOR- TRAN		Can support 8 addi- tional F/D drives; also available, VDP 44 with F/D (780K), £4,400
IMSAI VDP 80 (£6,200)	As above	32-64K RAM: 8085: dual 8" F/D (1.2MB): 12" 24x80 b&w VDU: 1 S/P: 1 P/P: 25"x15"x25"	IMDOS: A: Ex- H BASIC: U: CBASIC: COBOL: FOR- TRAN: CAP B/P		
ITT 2020 (£867) (32K, £931 48K, £995)	ITT: 0268 3040 (15)	16-48K RAM: 2020: 15"x 18"x4": options — single 5 1/4" F/D (116K), £425, C, £33; 60cps printer, £825; 16K RAM, £110; RS232 port, £96	Monitor: A: B ExBASIC: Dis-A: games		360x192 high resolution graphics: ExBASIC in 6K ROM.
LX-500 (£3,500)	Logabax Ltd: 01-965 0061 (13)	32K RAM: Z80: dual 5 1/4" F/D (180K): 12", 25x80 b&w VDU: 100bps printer: option — 80 col 60cps printer, £500	DOS: BASIC: S A		Other printers available.
MEGAMI- CRO (£6,080)	Bytronics: 0252 726814 (5)	256K: 8080A: dual 8" F/D (1MB): 12", 20x80 b&w VDU: 120cps printer: 2 S/P: 2 P/P: option — printer stand, £100	CP/M: U: H&B B/P		
MICRO- ENGINE (£2,080)	Pronto: 01-599 3041 (TBA)	64K RAM: MCP 1600: 2 RS232 ports: 2 P/P: 16"x13"x5": options — dual 5 1/4" F/D (1MB), £1,500; dual 8" F/D (2MB), £1,200	BASIC: PAS- CAL: File Manager: U	H&S	CPU has user written word set: PASCAL uses integral P code: available as board, £1,400

List of Abbreviations	C/P Commercial package E Extensive F/D Floppy disc G/C Graphics card H Hardware H/D Hard disc	I Introductory int interface I/S Indexed sequen- tial K/B Keyboard M/A Macro assembler N/P Numeric pad	O/S Operating system P/P Parallel port S Software S/P Serial port TBA To be announced T/E Text editor T/P Text processor	U Utility W/L Word length W/P Word processor
A Assembler				
B BASIC				
B/P Business package				
C Cassette				

Please note: Software items listed in *italic* are not included in the basic price of the equipment. All prices are *exclusive* of VAT

IN STORE

**DIRECT
ACCESS**

Machine (Price from)	Main Distributor/s (No. of dealers)	Hardware	Software	Documen- tation	Miscellaneous
MICRO-NOVA (£12,000)	Digitus: 01-636 0101 (3)	64-1128K RAM; N601: 10MB H/D (5 fix, 5 rem): 12" 24x80 VDU: 132 col 60cps printer: 4 S/P: 1 P/P	DOS: M/A: U: T/E: I/S: de- bug: FOR- TRAN IV: BASIC: PAS- CAL: W/P: B/P	E	Larger configs usual: bus system for multi- user; smaller system pos- sible with F/D
MICRO-STAR 45 PLUS (£4,950)	Data Efficiency: 0442 57137 (TBA)	64K RAM: 8085: dual 8" F/D (1.2MB): 3 S/P: RS232 port: 17"x26"x8"	STARDOS: CP/M: BAS- IC: COBOL: FORTRAN: UPDATE (database): B/P	E	
MSI 6800 (£1,203)	Strumech: 05433 4321 (5)	16K RAM: 6800: C: (9") 16x64 b&w VDU: 1 S/P: option - PROM prog	BASIC: mini A T/E: U	H&S	Up to 8 serial or parallel interfaces possible.
MSI 6800 SYSTEM 1 (£2,175)	As above	32K RAM: 6800: dual 5 1/4" F/D (160K): 9", 16x24 b&w VDU: 1 RS232 port: option - dual 8" F/D (624K), £1,640	DOS, BASIC: U: A: FOR- TRAN: T/E	H&S	As above
MSI 6800 SYSTEM 2 (£7,500)	As above	56K RAM: 6800: Single 8" F/D (312K): 10MB H/D: 1 RS232 port: 9", 16x64 b&w VDU: options - dual 8" FYD (624K), £1,640 10MB H/D £4,250	DOS: BASIC: multi-user BASIC: A: B/P	H&S	Rack mounted
NORTH STAR HORIZON (£4,650 for 48K)	Comart: 0480 215005. Comma: 0277 811131. Equinox: 01- 739 2387 (20)	24-56K RAM: Z80A: dual 5 1/4" F/D (360K): 15" 24x80 b&w VDU: 150cps printer: 2 S/P: 1 P/P	DOS: BASIC: CP/M: CO- BOL: FOR- TRAN: PAS- CAL: B/P	E	
PET 2001-8 (£550)	Commodore: 01-388 5702 (150)	8K RAM: 6502: C: 9", 25x40 VDU: IEEE488 (non standard) port: options - dual 5 1/4" F/D (353K), £795; 80 col 93cps printer, £645; expand to 32K RAM, £249	O/S: BASIC: A: FORTH: PILOT: games	I	Graphics facility: BASIC in 8K ROM: also avail- able, dual 5 1/4" F/D (800K), £995 + £30 for operating ROM
PET 2001 - 16/32 (£675) (32K, £795)	As above	16-32K RAM: 6502: C: 9", 25x40 green VDU: IEEE488 (non standard) port: options - dual 5 1/4" F/D (353K), £795; 80 col 93cps printer, £645	O/S: BASIC: A: FORTH: PILOT: games	I	As above but disc opera- ting ROM included.
POWER- HOUSE 2 (£1,200)	Powerhouse Micros: 0442 48422 (TBA)	32K RAM: Z80A: 5", 27x96 b&w VDU: 1 S/P: 1 P/P: 17"x11"x7": options - IEEE488 int, £110; C, £170; G/C, £190	FDOS: BOS: BASIC: games: C/P: ExBASIC (14K EPROM), £260	I	
RAIR BLACK BOX (£2,300)	Rair: 01-836 4663 (n/a)	32-64K RAM: 8085: dual 5 1/4" F/D (160K): 2 RS232 port: 20"x16"x 5": option - dual 5 1/4" F/D (520K), £1,000	CP/M: BASIC: COBOL: FOR- TRAN: M/A: T/E: B/P	H	16K RAM expansion, £250.
RESEARCH MACHINES 380 - Z (£1,048) (56K, £1,654)	Research Machines: 0865 49791 (n/a)	16-56K RAM: Z80A: C: RS232 port: 19"x16"x6": options - dual 5 1/4" F/D (168K), £895; dual 8" F/D (1MB), £1,695 (fitted in machine)	Tiny BASIC: games: graph- ics: A: Ex- BASIC: CBASIC: COB- OL: FOR- TRAN: AL- GOL: CP/M: U	S	Designed for education: high resolution graphics being developed
SDS 100 (£4,290)	Airameco: 0294 57755 (11)	64K RAM: Z80: dual 8" F/D (1MB): 12", 24x80 VDU: S100 bus: RS232 port: N/P: 1 P/P	CP/M: A: ExBASIC: COBOL: FORTRAN: CAF: B/P	E	Facility for 8K PROM
SEMEL 1 (£2,900)	Strutt Electrical: 0822 5439 (n/a)	16-64K RAM: Z80: single 8" F/D (250K): 12", 24x80 b&w VDU: RS232 port: options - single 8" F/D (250K), £500; light pen	BASIC: COBOL: FORTRAN: B/P	I	Supports up to 8 drives
SHARP MZ- 80K (£520-£740)	Sharp UK: 01-571 2157 2157 (22)	6-34K RAM: Z80: C: 10", 24x40 b&w VDU	BASIC: A: games	B	Graphics: loudspeaker: BASIC in 14K RAM

Machine (Price from)	Main Distributor/s (No. of dealers)	Hardware	Software	Documen- tation	Miscellaneous
SIMPELEC Mk I (£6,900)	Compelec: 01-636 1392 (n/a)	64K RAM; Z80: dual 8" F/D (1MB); 12", 24x80 VDU: 55cps daisywheel printer: 2 S/P: 1 P/P; options - 150cps bi-directional printer, £2,000; 55cps W/P printer, £2,000	CP/M: BASIC: W/P	S&H	Also available, Mk II with 2MB F/D, £7,900. Can upgrade to MkIII. Portable
SIMPELEC Mk III (£10,150)	As above	64K RAM; Z80: dual 8" F/D (1MB); 11MB H/D: 12", 24x80 VDU: 55cps daisywheel printer: 6 S/P: 1 P/P; options - 150cps bi-directional printer, £2,000; 55cps W/P printer, £2,000; W/P VDU, £900	CP/M: BASIC: W/P	S&H	Up to 44MB H/D possible, £4,500 extra. Multi-user system with 208K RAM, £12,150.
SIROCCO (£3,900)	Elvingate Computers: 069 24 5189 (TBA)	64K RAM; Z80: dual 5 1/2" F/D (740K); 12", 24x80 VDU: RS232 port: 19"x 14"x13"; options - up to 3 ports; 10MB H/D, £4,000	CP/M: CBASIC: COBOL: MBASIC: FORTRAN: PASCAL: LISP	S	Direct memory addressing. Memory mapped VDU. Free standing keyboard.
SMOKE SIGNAL CHIEFTAIN I (£3,050)	Windrush Micro Designs: 069-24 5189 (TBA)	32-64K RAM: 6800: dual 5 1/2" F/D (160K); 12", 24x80 VDU: 112cps printer: RS232C port: option - 16K RAM expansion, £500	DOS: BASIC: DBASIC: RBASIC: A: FORTRAN: U: T/E: B/P	E	Also available, Chieftain 3 with dual 8" F/D (1MB), £3,950.
SOLITAIRE/ WP (£6,750)	Solitaire/KPG: 04252 71448 (TBA)	64K RAM; 8085: dual 5 1/2" F/D (700K); 14" VDU (with own CPU): 45cps printer: CPU	DOS: W/P: BASIC	S	All Solitaire systems are compatible: graphics on 11x13 dot matrix
SOLITAIRE/ BS200 (£7,950)	As above	64K RAM; 8085: dual 8" F/D (960K); 14" VDU (with own CPU): 45cps printer: CPU port	DOS: BASIC: W/P: speciali- sed B/P	S	As above
SOLITAIRE/ HBS100 (£5,500)	As above	64K RAM; 8085: 10MB Fix H/D: 14" VDU (with own CPU): 200cps printer: CPU port: option - up to 40MB H/D	DOS: BASIC: W/P: speciali- sed B/P	S	Up to 8 interface ter- minals can be used: also available, HBS200 with 20-80MB H/D.
SORD M100 ACE (£2,650)	Midas Computer Services Ltd 0903 814523	48K RAM; Z80: single 5 1/2" F/D (143K); 12", 24x64 colour VDU: RS232 port: option - single 5 1/2" F/D, £300	O/S: BASIC	I	With colour graphics: 8K ROM
SORD M223 (£3,500)	As above	64K RAM; Z80: single 5 1/2" F/D (350K); 12", 24x80 b&w VDU: S100 bus: RS232 port: option - extra F/D, £450	O/S: BASIC: CAP B/P	I	Other configs possible.
SUPER- BRAIN (£1,995)	Icarus: 0632 29593 (TBA)	64K RAM; 2xZ80: dual 5 1/2" F/D (320K); 12", 25x80 b&w VDU: S100 bus: RS232: TRS80 port: 21"x23" x1 4"; options - dual 5 1/2" F/D (320K); dual 8" F/D (2.4MB); 8-120MB H/D	CP/M: A: BASIC: COBOL: FORTRAN: AFL: B/P	H&S	Limited graphics: main- frame interface available
TAND- BERG EC10 (£5,000)	Tandberg: 0532 35111 (n/a)	50K RAM; 8080A: single 8" F/D (250K); 12", 25x 80 b&w VDU: RS232 port	ExBASIC (24K): multi- user BASIC: A: U: COBOL	H&S	Pascal available next year
TANDY TRS 80 LEVEL 1 (£380)	Tandy: 021 556 6101 (200)	4-16K RAM; Z80: C: 12", 16x64 b&w VDU	BASIC: games: I A	I	BASIC in 4K ROM: up- gradable to level 2
TANDY TRS 80 LEVEL 2 (£515- £1,005)	As above	4-48K RAM; Z80: C: 12", 16x64 b&w VDU: RS232 int: 1 P/P; option - single 5 1/2" F/D (78K), £478 (max of 4)	BASIC: games: I M/A: FOR- TRAN: B/P	I	16K machines include N/P: 4-16K upgrade, £120; without pad, £85
List of Abbreviations	C/P Commercial package E Extensive F/D Floppy disc G/C Graphics card H Hardware H/D Hard disc	I Introductory int Interface I/S Indexed sequen- tial K/B Keyboard M/A Macro assembler N/P Numeric pad	O/S Operating system P/P Parallel port S Software S/P Serial port TBA To be announced T/E Text editor T/P Text processor	U Utility WL Word length W/P Word processor	

Please note: Software items listed in *italics* are not included in the basic price of the equipment. All prices are *exclusive* of VAT

Machine (Price from)	Main Distributor/s (No. of dealers)	Hardware	Software	Documen- tation	Miscellaneous
TECS (£1,600)	Technologies: 051 724 2695 (TBA)	16-56K RAM: 6800: 8K PROM: RS232 port: C int: option — dual 5 1/4" F/D (320K), £800	BASIC	H	256 char graphics: Pres- tel compatible: plugs into standard TV
TEI 208 (£4,400)	Abacus: 01-580 8841 (5)	32-60K RAM: 8080/8085: dual 5 1/4" F/D 320K: 9" 24x80 green VDU: 3 S/P: 3 P/P: 17"x18"x10": option — 150cps printer, £1,250	CP/M: BASIC: H&S COBOL: FOR- TRAN: PAS- CAL: ALGOL: B/P	H&S	
TEI 212 (£5,067)	As above	32-60K RAM: 8080/8085: dual 8" F/D (1MB): 15", 24x80 green VDU: 3 S/P: 3 P/P: 17"x20"x17": option — 150cps printer, £1,250	CP/M: BASIC: H&S COBOL: FOR- TRAN: PAS- CAL: ALGOL: B/P	H&S	
TERODEC DPS 64/1-4 (£3,014)	Terodec (Microsystems) Ltd: 0344 51160 (TBA)	64K RAM: Z80: dual 8" F/D (1MB): 12", 24x80 b&w VDU: 2S/P 3P/P: options — dual 8" F/D (1MB), £1,150; dual 8" F/D (2MB), £1,455	CP/M: BASIC: H&S CBASIC: COBOL: FOR- TRAN: ALGOL: PASCAL: W/P: B/P: DATA- BASE	H&S	TMZ 80 enhanced model in integral work- station £5,495, (with 4MB F/D); DPS 64 with 2MB F/D is £3,319
VECTOR GRAPHICS MZ (£2,300)	Almare: 0602 248565 Sintrom Microshop 0734 84322 (5) Microtech: 0895 57780 (5)	48K RAM: Z80: dual 5 1/4" F/D (630K): 1 S/P: 2 P/P: 20"x17"x8"	DOS: BASIC: E A: CP/M: CBASIC: COBOL: FORTRAN: PASCAL:	E	4K PROM
VECTOR GRAPHICS SYSTEM B (£2,850)	As above	48K RAM: Z80: dual 5 1/4" F/D (630K): 12", 24x80 b&w VDU: 1 S/P: 2 P/P: 20"x17"x8"	DOS: BASIC: E A: CP/M: CBASIC: COBOL: FOR- TRAN: PASCAL:	E	With graphics and N/P
ZENTEC (£5,700)	Zigal Dynamics: 0753 71049 (1)	32-64K RAM: 2x8080: dual 5 1/4" F/D (280K): 15", 25x80 b&w VDU: RS232 port: options — dual 5 1/4" F/D (280K, £600; dual 8" F/D (1MB), £2,100 RS422 port, £105	O/S: A: U: BASIC: micro COBOL: W/P	S	User programmable character set
ZILOG MCZ1/05 (£4,200 - portable)	Micropower: 0256 54121. Memec: 084421 5471 (n/a)	64K RAM: Z80: dual 8" F/D (600K): RS232 port	Rio O/S: M/A: U: T/E: BASIC: COBOL: FORTRAN: PASCAL: B/P	H&S	Debug in 3K PROM: also available as desk top unit or R/M model, both £4,800.
ZILOG MCZ1/35 (£1,200)	As above	64K RAM: Z80: 10MB H/D (5 fix, 5 rem): RS232 port	Rio O/S: M/A: H&S U: T/E: BASIC: COBOL: FORTRAN: PASCAL: B/P	H&S	Internal disc control with own Z80
Z-PLUS (£4,000)	Rostronics: 01-874 3665 (TBA)	32-64K RAM: Z80: dual 8" F/D (1MB): 2 S/P: 2 P/P: 10"x29"x11"	CP/M: A: U: BASIC: COBOL: FORTRAN: PASCAL: Database: B/P	H&S	

SINGLE BOARDS

ACORN (£65)	Acorn: 0223 312772 Microdigital: 051227 2535. Newbear: 0635 30505 (n/a)	1.1/8K RAM: 6502: EPROM socket: Hex K/B: C int: 8 digit LED display: up to 16 ports: options — Eurocard 64 way connector: VDU card: Full K/B card.	1/8K monitor: Basic	S&H	Kit: programmable address linking; on board 5V regulator: available assembled, £79.
AIM 65C (£265)	Peico: 0273 722155 (4)	1-4K RAM: 6502: 12K ROM: full K/B: 20 char LED display: 20 char thermal printer: Cx2: RS232 port.	A: Dis A: T/E: 8K moni- tor in ROM	E	Available as S100 system with A or BASIC in ROM (£480) from Portable Micros (0280 702017): they also have briefcase version (£750).
CROMEM- CO SC (£260)	Comart: 0480 30505 (17)	1K RAM: Z80A: 8K EPROM sockets: RS232 port: 3 P/P: option — S100 bus.	Monitor and control BASIC in EPROM	E	5 program intertimers: can put own BASIC programs in EPROM.

DIRECT ACCESS

IN STORE

Machine (Price from)	Main Distributor/s (No. of dealers)	Hardware	Software/Firmware	Documentation	Miscellaneous
ELF II (£114)	Newtronics: 01-739 1582 (15)	1/4K RAM: RCA 1802; Hex K/B; 2 digit LED; TV int: C int: RS232 port: options — 4K RAM, £69; full K/B; VDU card	1K monitor: A: Dis A: T/E: BASIC: games	H	TTY, n-line decoders: low resolution graphics (high resolution available) kit.
EXPLORER (£295)	Newtronics: 01-739 1582 (15)	4K RAM: 8085; Hex K/B: RS232 port: S100 bus: C int: options — 6 slot S100, £32; 8K EPROM sockets, £50	2K monitor: CP/M: BASIC	S&H	Programmable 14 bit counter: kit
H8 (£262)	Heath: 0452 29451 (TBA)	4K RAM: 8080A; Octal K/B; 6 digit LED; speaker: options — single 5/4" F/D (102K), £399; 16K RAM, £314; C int, £72	1K monitor: BASIC in RAM: FORTRAN: T/E: A: U: games.	S&H	Kit
HEWART 6800S (£299)	Hewart: 0625 22030 (n/a)	16K RAM: 6800: full K/B: VDU int: 2x C int: 1 S/P: 2 P/P: option — 16K RAM, £90.	1K monitor: A: T/E	H	Can be upgraded with 6809.
HEWART 6800 Mk III (£152)	As above	1K RAM: 6800: VDU board: options — single 5/4" F/D (75K), £350; PROM programmer, £32; calculator board, £32	1K monitor	H	
Mk 14 (£39.95)	Science of Cambridge: 0223 311488 (n/a)	8060: 1/4-2K RAM: Hex K/B: 7 char LED: options — VDU int (32x16 with graphics), £29; C int, £6; PROM prog, £10, 2K memory expansion, £15	Machine code	H	Designed for control applications rather than high level computing expansion.
NASCOM 1 (£165)	Nascom: 02405 75155 (20)	4K RAM: Z80: full K/B: TV int: 2 P/P: 1 S/P	2K monitor: BBASIC: tiny BASIC: A: T/E: U	S&H	Now available as Nascom 2 with 8K RAM and 8K microsoft BASIC in ROM, £295
SBC 100 (£135)	Airameco: 0294 57755 (11)	1K RAM: Z80: 8K ROM: S100 bus: 1 S/P: 1 P/P: option — voltage regulator.	1K monitor: DOS in ROM	E	Kit: available assembled, £196
SUPERBOARD (£188)	NBM: 01-981 3993 (n/a)	4-8K RAM: 6502: 10K ROM: full K/B: VDU int: C int: options — RS232; single 5/4" F/D (100K), £316; 8K RAM, £188	BASIC in 8K ROM: games: B/P: Database	S&H	Available with 32K RAM and single 5/4" F/D, £867
SYM-1 (£160)	Newbear: 0635 30505 (n/a)	1-4K RAM: 6502: Hex K/B: 244 bps C int: VDU int: 2x6522 ports: option — TV int.	4K monitor: BASIC: A	S&H	Can be expanded to 64K RAM
TRITON 4.1 (£286)	Transam: 01-402 8137 (n/a)	2K RAM: 8080: 3K ROM: full K/B: 16x64 VDU or TV int: C int: 1 S/P: option — 2K RAM, £30	1K monitor: 2K BASIC: U	S&H	64 character graphics: 8 levels interrupt: kit
TRITON 5.1 (£294)	As above	2K RAM: 8080: 4K ROM: full K/B: 16x64 VDU or TV int: C int: 1 S/P: C: options — 8K RAM, £97; 8K EPROM, £97	1K monitor: 2K ExBASIC: U	S&H	Kit: assembled version, £393
TRITON 6.1 (£399)	As above	2K RAM: 8080: 4K ROM: full K/B: 16x64 VDU or TV int: C int: 1 S/P: C: options — 8K RAM, £97; 8K EPROM, £97	2K monitor: 7K scientific BASIC in 8K EPROM or A: Dis A: U	S&H	Either firmware package available for extra £110: CP/M compatible disc interface available soon.
UK 101 (£219)	Computer Shop: 01-440 7033	4K RAM: 6502: full K/B: 16x48 VDU or TV int: C int: RS232 port: option — 4K RAM, £49	1K monitor: 8K BASIC: Dis A: U	S&H	Graphics: will run Superboard software.

List of Abbreviations	C/P Commercial package	I Introductory int Interface	O/S Operating system	U Utility
A Assembler	F Extensive F/D Floppy disc	I/S Indexed sequential	P/P Parallel port	W/L Word length
B BASIC	G/C Graphics card	K Keyboard	S Software	W/P Word processor
B/P Business package	H Hardware	M/A Macro assembler	S/P Serial port	
C Cassette	H/D Hard disc	N/P Numeric pad	TBA To be announced	
			T/E Text editor	
			T/P Text processor	

Please note: Software items listed in *italic* are not included in the basic price of the equipment. All prices are *exclusive* of VAT

DIARY DATA

**DIRECT
ACCESS**

Wembley, England	Microsystems '80 Exhibition & Conference. Iliffe Promotions Ltd., Dorset House, Stamford St., London SE1 9LU. Tel: 01-261 8000.	Jan 30 - Feb 1
Leeds, England	BEX - Business Equipment Exhibition. Douglas Temple Studios Ltd., 104b Old Christchurch Rd., Bournemouth, Dorset. Tel: 0202 20533	Feb 6 - Feb 7
Solihull, England	Mini Computers, Word Processors & Copying Machines Exhibition. Groundrule Exhibition Company, 7 Market Street, Altrincham, Cheshire WA14 2QW. Tel: 061 928 2227	Feb 12 - Feb 13
London, England	Business Computing, Word Processing & Information Mgt., Exhibition & Conference. BED Exhibitions Ltd., Bridge House, Restmor Way, Wallington, Surrey. SM6 7BZ. Tel: 01-647 1001	Feb 12 - Feb 15
Wembley, England	IMEC - European Information Management Exhibition & Conference. Clapp & Poliak Europe Ltd., 232 Acton Lane, London W4 5DL. Tel: 01-995 4806	Feb 18 - Feb 21
Bournemouth, England	BEX - Business Equipment Exhibition. Douglas Temple Studios Ltd., 104b Old Christchurch Rd., Bournemouth, Dorset. Tel: 0202 20533	Feb 20 - Feb 21
Swansea, Wales	OFFEX - Office Equipment Exhibition. Phoenix Exhibitions Ltd., 1st Floor, Burrows Chambers, East Burrows Rd., Swansea. Tel: 0792 460364	Feb 20 - Feb 22
Birmingham, England	IEA - International Instruments, Electronics & Automation Exhibition. Industrial & Trade Fairs Ltd., Radcliffe House, Blenheim Court, Solihull, West Midlands, B91 2BD. Tel: 021 705 6707	Feb 25 - Feb 29
Milan, Italy	International Exhibition of Numerical Control, Automation & Industrial Robots. CEU S.p.A., Via Monte Rose 21, 21049 Milan	Mar 3 - Mar 7
Birmingham, England	Computermarket '80, Couchmead Ltd., 42 Great Windmill Street, London W1V 7PA. Tel: 01-437 4187	Mar 4 - Mar 6
London, England	Microforum Europe. Business Equipment Trade Association, 109 Kingsway, London WC2B 6PU. Tel: 01-405 6233	Mar 11 - Mar 13
Manchester, England	Computermarket. Couchmead Ltd., 42 Great Windmill Street, London W1V 7PA. Tel: 01-437 4187	Mar 11 - Mar 13
Sheffield, England	Business Efficiency & Office Equipment Exhibition. Gwen Shillaber Design, 81 Whiteladies Road, Clifton, Bristol, B8 2NT. Tel: 0272 312850	Mar 11 - Mar 13
Glasgow, Scotland	Computermarket '80. Couchmead Ltd., 42 Great Windmill Street, London W1V 7PA. Telephone: 01-437 4187	Mar 18 - Mar 20
London, England	Computermarket '80. Couchmead Ltd., 42 Great Windmill Street, London W1V 7PA. Telephone: 01-437 4187	Mar 25 - Mar 27
London, England	Viewdata '80 Exhibition. Online Conferences Ltd., Cleveland Road, Uxbridge, UB8 2DD. Tel: 0895 39262	Mar 26 - Mar 28
Brighton, England	Computer Aided Design Conference & Exhibition. Iliffe Promotions Ltd., Dorset House, Stamford Street, London SE1 9LU. Tel: 01-261 8000	Mar 31 - Apr 2
London, England	Peripherals '80 Exhibition. Iliffe Promotions Ltd., Dorset House, Stamford Street, London SE1 9LU. Tel: 01-261 8000.	Apr 16 - Apr 17
London, England	All Electronic Show. All Electronic Show, 34-36 High Street, Saffron Walden, Essex. Tel: 0799 22612	Apr 29 - May 1
Liverpool, England	Mersey Micro Show. Online Conferences Ltd., Cleveland Road, Uxbridge UB8 2DD. Tel: 0895 39262	April 30 - May 2
Brussels, Belgium	Compec Europe Exhibition. Iliffe Promotions Ltd., Dorset House, Stamford Street, London SE1 9LU. Tel: 01-261 8000.	May 6 - May 8
Manchester, England	Business Efficiency & Office Equipment Exhibition. Gwen Shillaber Design, 81 Whiteladies Rd., Clifton, Bristol B8 2NT. Tel: 0272 312850	May 13 - May 15
London, England	International Word Processing Exhibition and Conference. Business Equipment Trade Association, 109 Kingsway, London WC2B 6PU. Tel: 01-405 6233	May 20 - May 23

TRANSACTION FILE

**DIRECT
ACCESS**

For Sale

Pet 2001-8K. . . complete with manuals, assembler, games, BASIC book and BASIC games book. Perfect condition, only use - £450 ono. Contact Peter Toogood, 41 Dukes Avenue, London N10 2PX (01-883 1560).

Norris Electronic Projector. . . almost new - £225. Phone Atherstone (Warks) 2560.

Nascom 1. . . B-Bug (2K) monitor, complete, fully socketed board and keyboard, UHF modulator, tested and operational. PSU not included - £160 ono. Phone Lee on 01-549 0279 (evenings/weekends).

All going cheap. . . Z-Plus Microcomputer/Disc - Z80, 64K, 1M Byte with Elbit Terminal 1920-X - £3,000; IP125 Matrix Printer - £400; Nascom 1 - £150; Tektronix Scope 545 - £100.

Owner going overseas - phone 01-543 1398.

Pet 2001-8K. . . limited home use, excellent condition, complete with 2nd cassette and many programs - £495 ono. Also P.E. VDU board, needs attention, hence only £10. KB756 ASCII Keyboard - £25. Phone Cardiff 562133.

CompuKit UK101. . . fully working with all leads, 8K memory, original plus extra software, manual and additional articles - £300 ono. Can demonstrate in London at weekends. Phone 047335 687 (Ipswich).

TI-59. . . plus PC100B - £200 (will split). Phone Crawley 36173.

UK101. . . 4K RAM, 8K BASIC in specially built case with cassette recorder, mains and TV leads. Programs on cassette tape - £300. Contact J. G.

Walton, 7 Halfield Road, Newton, Derbys (Ripley 873244).

SWTPC 68000 Disc System. . . 16K RAM, dual 5in floppy, FLEX operating system, editor, assembler, BASIC, many extras. Fully working. I am happy to arrange a demonstration anywhere - £850 ono. Phone 01-994 2360 any evening.

Challenger 1P. . . 8K RAM, UK Power Supply, UHF modulator, 8K Microsoft BASIC, plus supplied and extra software. As new - £300. Phone Ruislip 72852 (after 6.30pm).

Nascom 1. . . complete and working in Verocase. Fully documented, inc £30 worth of books - £226. Phone Lancaster (0524) 67105.

Apple II 48K. . . great value! 3 months old and still under guarantee. It includes parallel printer interface card Applesoft

Now, the complete MK 14 micro-computer system from Science of Cambridge

VDU MODULE. £33.75

(£26.85 without character generator) inc. p & p.

Display up to 1/2K memory (32 lines x 16 chars, with character generator; or 4096 spot positions in graphics mode) on UHF domestic TV. Eurocard-sized module includes UHF modulator, runs on single 5V supply. Complete ascii upper-case character set can be mixed with graphics.

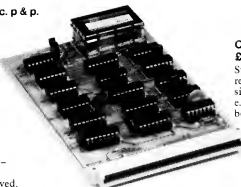

CASSETTE INTERFACE MODULE. £7.25, inc. p & p.

Store and retrieve programs on any cassette recorder. Use for serial transmission down single line at up to 110 baud (teletype speed), e.g. over telephone line, and to communicate between two or more MK 14s.



POWER SUPPLY. £6.10 inc. p & p.

Delivers 8V at 600 mA from 220/240V mains - sufficient to drive all modules shown here simultaneously. Sealed plastic case, BS-approved.

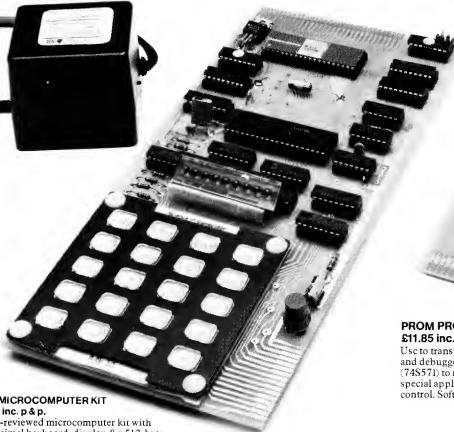

MK 14 MICROCOMPUTER KIT

£46.55 inc. p & p.

Widely-reviewed microcomputer kit with hexadecimal keyboard, display, 8 x 512-byte PROM, 256-byte RAM, and optional 16-lines I/O plus further 128 bytes of RAM.

Supplied with free manual to cover operations of all types - from games to basic maths to electronics design. Manual contains programs plus instructions for creating valuable personal programs. Also a superb education and training aid - an ideal introduction to computer technology.

Designed for fast, easy assembly; supplied with step-by-step instructions.

PROM PROGRAMMER. £11.85 inc. p & p.

Use to transfer your own program developed and debugged on the MK 14 RAM to PROM (74571) to replace SCI05 monitor for special applications, e.g. model railway control. Software allows editing and verifying.

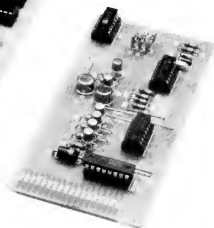

To order, complete coupon and post to Science of Cambridge
Return as received within 14 days for full money refund if not completely satisfied.

To: Science of Cambridge Ltd, 6 Kings Parade, Cambridge, Cambs., CB2 1SN.

Please send me:

- MK 14 standard kit @ £46.55.
 Extra RAM @ £4.14 per pair.
 RAM I/O device @ £8.97.
 VDU module including character generator @ £33.75.
 VDU module without character generator @ £26.85.
- Cassette interface module @ £7.25.
 PROM programmer @ £11.85.
 Power supply @ £6.10.
 Full technical details of the MK 14 System, with order form.

All prices include p+p and VAT.

I enclose cheque/MO/PO for £..... (total).

Name.....

Address (please print).....

Science of Cambridge Ltd

6 Kings Parade, Cambridge, CAMBS., CB2 1SN.
Tel: 0223 311488.

PCW/2/80

F.P., BASIC ROM card, colour and graphics card - £1,218 (saves you £300). Apple Dual Disk II with controller and box of diskettes - £769 (saving £177); OR £1,950 the lot. Phone Mike McKibbin on Malmesbury (06662) 3963 (day).

Nascom 1. . . no need to slave with a soldering iron, this is ready built by a professional for use by an amateur. Includes standard documentation plus a few programs, complete with keyboard, ribbon cable and Aztec modulator - only £150 ono. Phone Stevenage (0438) 53807.

Tandy TRS 80. . . 4K Level II, system built into moveable Hi-Fi cabinet, with extending keyboard. Complete with technical manual and instruction books etc; also software. Offers, or exchange for Pet. Phone Hereford 3047.

OSI Superboard II. . . 4K, plus PSU, cased - £300; 2K RAM, type 211 (bought for Triton but unused) - £30; Module KB 756 Professional ASCII keyboard plus data (cased) - £50; P.E. VDU, built - £60 (keyboard plus VDU - £90). Contact B. Mistry, 75 St Margaret's Road, Bradford.

Centronics 779. . . excellent condition, 9 months old, lightly used - £700 ono; also SWTPC PR 40 - £150 ono. Phone Kings Langley 62469.

S100 Tarbell Cassette Interface. . . built and working (gone to floppies) - £80. Contact Geoff Cass, 4 Kingsley Place, Heaton, Newcastle-upon-Tyne NE6 5AN.

CP1600. . . 16 bit CPU, won in raffle, with data. Swap/sell/even free to a good home! Contact Ken Turner (GM4HQR), 31 Duddingston Park South, Edinburgh EH15 3NZ (031-669 3363).

KSR33 Teletype. . . 20MA/CL with plug in interface for 380Z. Recently serviced - offers. Phone 061-494 0990.

Creed Envoy ASR. . . ASCII upper/lower case, V24 interface, immaculate, makes a Teletype look like a plastic kit - £300; Tandberg TDC 3000 Cartridge Data Recorder - £130. Contact D. J. Mounter, 9 Chestnut Road, Watten, Thetford, Norfolk, IP25 6RG.

Paper Tape. . . several reels, 8in diameter 7/8in wide - offers? Also Punched Card Reader, large but complete with manuals and circuits. Lots of useful parts - offers? Phone 01-449 1690.

Nascom 1. . . built and in working order. Hardware: Verocase, PSU, 16K RAM, Kansas City Interface, Buffer Board. Firmware: T4, Nas-Sys, Super Tiny BASIC. Software: mostly games. Also Motorola D2. Offers? Phone Dave on Kendal (0539) 27789.

TI-58 and HP33E calcs. . . complete with all accessories as supplied. Both in first-class condition, both £35 plus p&p. Phone Frank on 041-778 2419 (after 7pm).

Two IBM 7330 Magnetic Tape Drives. . . FREE if you have them both and can transport them (they are very heavy). At least one was working when stored. Manuals and circuits included. Phone Wentworth 4275.

Pet 2001-8K. . . £395; Teletype ASR33 - £395; Interface B - £140; Teletype stand - £20. All as new condition, also books and programs. Offers? Contact Dave Bird, 92 Gardiner Street, Gillingham, Kent (0634 53127).

Wanted

Personal Computer World. . . Volume 1, numbers 4 and 5. Phone Mark Whidby on 061-273 7121 ext 5676 (office hours only).

Apple, Pet, Sorcerer or TRS 80. . . newish, have Philips N1700LP VCR, Phillips 14825 14in col portable, Bell & Howell 2143XL Lowlight cine camera, all brand new, boxed with guarantees - plus other brand new Hi-Fi items. Cash either way. Phone Geoff Heward 021-353 6589 (evenings) and start haggling.

FAX

The 6502 mnemonics arranged by op-code Based on information contained in "Programming the 6502" by Rodney Zaks
Published by Sybex

LSB MSB	0	1	2	3	4	5	6	7	8	9	A	B	C	D	E	F
0	BRK	ORA-I, X				ORA- 0-P	ASL- 0-P		PHP	ORA- IMM	ASL- A			ORA	ASL	0
1	BPL	ORA-I, Y				ORA- 0-P,X	ASL- 0-P,X		CLC	ORA, Y				ORA, X	ASL, X	1
2	JSR	AND-I, X			BIT- 0-P	AND- 0-P	ROL- 0-P		PLP	AND- IMM	ROL- A		BIT	AND	ROL	2
3	BMI	AND-I, Y				AND- 0-P,X	ROL- 0-P,X		SEC	AND, Y				AND, X	ROL, X	3
4	RTI	EOR-I, X				EOR- 0-P	LSR- 0-P		PHA	EQR- IMM	LSR- A		JMP	EOR	LSR	4
5	BVC	EOR-I, Y				EOR- 0-P,X	LSR- 0-P,X		CLI	EOR, Y				EOR, X	LSR, X	5
6	RTS	ADC-I, X				ADC- 0-P	ROR- 0-P		PLA	ADC- IMM	ROR- A		JMP- I	ADC	ROR	6
7	BVS	ADC-I, Y				ADC- 0-P,X			SEI	ADC, Y				ADC, X		7
8		STA-I, X			STY- 0-P	STA- 0-P	STX- 0-P		DEY		TXA		STY	STA	STX	8
9	BCC	STA-I, Y			STY- 0-P,X	STA- 0-P,X	STX- 0-P,Y		TYA	STA, Y	TXS			STA, X		9
A	LDY- IMM	LDA-I, X	LDX- IMM		LDY- 0-P	LDA- 0-P	LDX- 0-P		TAY	LDA- IMM	TAX		LDY	LDA	LDX	A
B	BCS	LDA-I, Y			LDY- 0-P,X	LDA- 0-P,X	LDX- 0-P,Y		CLV	LDA, Y	TSX		LDY, X	LDA, X	LDX, Y	B
C	CPY- IMM	CMP-I, X			CPY- 0-P	CMP- 0-P	DEC- 0-P		INV	CMP- IMM	DEX		CPY	CMP	DEC	C
D	BNE	CMP-I, Y				CMP- 0-P,X	DEC- 0-P,X		CLD	CMP, Y				CMP, X	DEC, X	D
E	CPX- IMM	SBC-I, X			CPX- 0-P	SBC- 0-P	INC- 0-P		INX	SBC- IMM	NOP		CPX	SBC	INC	E
F	BEQ	SBC-I, Y				SBC- 0-P,X	INC- 0-P,X		SED	SBC, Y				SBC, X	INC, X	F
	0	1	2	3	4	5	6	7	8	9	A	B	C	D	E	F

I = indirect 0-P = page zero

MICROMART

APPLE and PET SYSTEMS in DUBLIN

* Come and try these fine computers
in our showrooms

Sensible Software for Apple

* Sales, Creditors Ledgers; Financial
Modelling

* Educational systems in Maths,
Physics, Geography, Commerce.

SOFTTECH

SOFTTECH Ltd., 51 Lr Camden St.,
Dublin 2, Ireland. Phone Dublin 784739

Modata

30 ST. JOHN'S ROAD
TURBIDGE WELLS
KENT

Telephone: Turbidge Wells (0682) 41555

DIGITAL MICROSYSTEMS
LOW COST BUSINESS COMPUTERS

DSC-2
ONE to 29 MEGABYTES DISK STORAGE
84 Kbytes of Main Memory - STANDARD
Digital Research CP/M operating system - STANDARD

TEXT PROCESSING, BASIC, COBOL
FORTRAN available

HEX-28
32 to 96 MEGABYTES DISK STORAGE
32 USER & 16 TASK capability - STANDARD
Rearment ASSEMBLER & BASIC - STANDARD

Floppy disk based development system
available

MODATA is an authorized DEALER in Ireland (UK and IRE) 400

EPROM ERASER

ERASE 32 DEVICES IN 15 MINS
RUNS COOL WITH LOW OZONE
COMPACT, PROFESSIONAL QUALITY UNIT

200 - 250v OPERATION

£39.95 ALL INCLUSIVE

C.W.O. OR COMPANY ORDER

FULL DESCRIPTION ON REQUEST

TEX MICROSYSTEMS LTD

126 NEW HOUSE PARK, ST ALBANS.
64077 AFTER 7 P.M.

MICRO PROCESSOR POWER UNITS

input 110-240VAC outputs 2x5v@
approx 1.5 amps crowbar protection
24v @ 3.5amps, 24v @ 300mA.
All outputs floating, enabling any
combination of voltage dividers to
obtain ± 12v etc. Documentation
and circuits supplied with each unit.
£18 each + vat. MANY OTHER

SURPLUS COMPONENTS
AVAILABLE. S.A.E.

To: GRAHAM BOND,
CRISTIE ELECTRONICS LTD

RODNEY HOUSE,
CHURCH STREET, STROUD,
GLOUCESTER
Tel 04536 79821

COMMUNICATION

Continued from Page 43

of the segment pattern of the
initial letter of the word,
from 0F12 to 0F1A (if we
want the second word), or to
0F22 (if we want the third
word)

We shall need 4 counters.
The message has 3 words:
Counter 1 is set initially to 3
and is decremented after
displaying each word.

There are 8 positions in
the display: Counter 2 is set
initially to 8.

To have a word in the
display for a convenient
period, we need to go
through the scanning
process a certain
number of times. Counter 3
is set initially to this number.
(20 - in hex - is a
convenient value).

To have a pause of suitable
duration, we need to go
through a delay loop a
certain number of times.
Counter 4 is set initially to
this number. (10 - in hex - is
a convenient value).

With the subroutine,
during the pause which
follows the third word,
the last word appears in the
display. If we wish to avoid
this, before executing the
delay loop in the main
program, we can send "00" to
0D00.

If the last character of the
last word of the message is
a full-stop, it will be
displayed during the pause
which precedes the
repetition of the
message. We may prefer
this. If the last character
of the last word is not a
full-stop, we may wish to
avoid its display during the
pause. The following
modification to the main
program will prevent it:

0F5B	C4	00
0F5D	C5	01
0F5F	C4	FF
0F61	8F	FF
0F63	B8	1D
0F65	9C	F8
0F67	90	D6

Tom Palmer, Kew

Program for displaying words in the Mk. 14

Main Program

0F12	—	0F37	Reserved for the message.
0F38	00	Counter 1	
0F39	C4	0D	Sub-routine
0F3B	35	0F7F	00
0F3C	C4	0F80	00
0F3E	36	0F81	00
0F3F	C4	0F82	01
0F41	C8	0F83	C4 20
0F43	C4	0F85	C8 FA
0F45	C8	0F87	C4 08
0F47	C4	0F89	31
0F49	30	0F8A	C4 08
		0F8C	C8 F2
0F4A	B8	0F8E	C4 12
0F4C	98	0F90	32
0F4E	C0	0F91	C6 01
0F50	02	0F93	CD FF
0F51	F4	0F95	C4 FF
0F53	C8	0F97	BF 05
0F55	90	0F99	B8 E5
0F57	C4	0F9B	9C F4
0F59	C8	0F9D	B8 E2
0F5B	C4	0F9F	9C E6
0F5D	8F	0FA1	01
0F5F	B8	0FA2	30
0F61	9C		
0F63	90	DA	

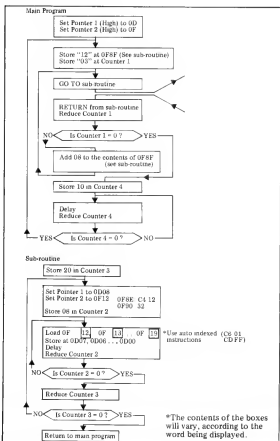

BLUDNERS

Sorry, all you eagle-eyes, we beat you to it. Here follows
what should in fact have come at the end of this month's Systems.

Other suppliers of purchase ledger packages that we know about are:

Byte Shop	01-518 1414
Comma Computers Ltd	0277 8111 31
Computa Store Ltd	061-832 4671
Crystal Electronics	0803 22699
Digitus Ltd	01-636 0105
Equinox Computers Ltd	01-739 2387
Graffcom	01-734 8862
Katanna Management	

Services Ltd	0245 76127
Microcomputation	01-882 5104
Micro-Facilities Ltd	01-979 4546
Micromedia (Systems) Ltd	0633 63310
Microsolve Computer Services	01-951 0218
Padmede Ltd	025-671 2434
Profcomp Ltd	01-989 8177
Templeman Software Services	0789 66237
Tridata Micros Ltd	021-622 1754
3-Line Computing	0482 859169

PROGRAMS

Submitting programs to PCW

Having written and thoroughly tested your original program (be it an application, a game or a useful subroutine) send it to us, along with a suitable explanation. In order of preference we would like your program submitted as a clear, dark listing on plain paper; on cassette or disc; clearly, accurately typed; or, clearly, accurately handwritten.

We pay the sender of any listing published — at least £10 and often much more — depending on the size

and quality of the contribution. If the program is too large or complex for the "Programs" section we will sometimes publish it as a feature in the magazine.

It seems that PET users are in the majority . . . we get more of their programs than any others. For the sake of "balance" how about you others pitching in as well? Post your submissions to PCW Programs, 14 Rathbone Place, London W1P 1DE. We look forward to hearing from you.

380Z Pictures

by John Yale

The program is an interpreter written in BASIC for a 16K Research Machines 380Z to draw pictures on the TV screen. It should be adaptable to any computer with memory mapped display.

Commands to control the picture come from one of two sources:

- 1 Immediate commands from the keyboard.
- 2 Commands stored in DATA statements at the end of the program. The commands are an extension of those used in Reference 1.

The plotting area used is 79x47 cells. This is one cell smaller than allowed on the 380Z but provides better displays. This may be changed at line 30. When the trace goes off the screen, it reappears at the opposite side.

Initially the program is in stored program mode. Enter the number of the program stored in the data statements that is required. To add new programs, ensure that they start with "PROG" and finish with "END".

Entering zero or just 'RETURN' will switch to immediate command mode. Pushing 'RETURN' again will switch back to stored program mode.

In immediate mode, command strings are entered from the keyboard, terminated by carriage return, when

they will be executed. For example, to draw a line ten units long enter 10F RETURN. To draw a square enter 4(10F2R) RETURN.

Macros may be defined using the 'D' command, e.g. D G 5F RETURN defines G to be equivalent to 5F. Macros may refer to other macros or even themselves in their definition (see PROG 1).

If a macro is redefined then the most recent definition will be used.

To view the current macro type 'LIST' in immediate mode. Note that this will restore the full screen scroller. Execute command 'C' to restore the plotting area.

Different screen sizes will produce different patterns with programs 2,3 and 4. Also try turning program 3 through 45 degrees by the immediate command 'R' before running it. These three programs will generate different patterns for hours with totally unexpected patterns appearing.

REFERENCE

Yet another body — Ken Anderson. DR DOBBS JOURNAL VOL 3 Iss 5. Some additions to Lichen Wangs Robot control language for the 8080.

```

TYPE YAL03.BAS
● 10 CLEAR 500
● 20 DI A$(25),SI(25),SI(25),S4(25)
● 30 X4=78:Y4=46:REM ** SCREEN SIZE **
● 40 P1=2:RE4 ** WHITE TRACE **
● 50 PI=0:PA=0:PN=0:REM ** STACK POINTERS **
● 60 GOSUB 1230:GOSUB 1190:GOSUB 1210
● 70 C1$="FR-- /()MTHN02.42S="
● 80 INPUT "PROG NO.":P
● 90 IF P<>0 THEN 230
● 100 INPUT "ENTER COMMAND STRING":A$
● 110 IF A$="" THEN L1=0:GOTO 30
● 120 IF A$<>"LIST" THEN 130
● 130 REM ** LIST PROGRAM **
● 140 GRAPH 0
● 150 FOR N=1 TO L1:PRINT A$(N):NEXT
● 160 GOTO 100
● 170 REM ** EXECUTE IMMEDIATE COMMAND **
● 180 IF LEFT$(A$,1)<>"0" THEN 210
● 190 REM ** SAVE NEW MACRO **
● 200 L1=L1+1:A$(L1)=A$:GOTO 100
● 210 N=0:GOSUB 410:GOTO 100

```

MICROMART

ANNOUNCING
A ONE DAY INTENSIVE COURSE
including: Basic Programming, Systems,
Flow-Charting, Machine Code, etc., etc.

(50% of programming time spent
actually using micro-computers)

Date: 5th February, 1980
Venue: EUROCREST HOTEL, WEMBLEY.
Price: £46.00 (inc: LUNCH & VAT)

LIMITED NUMBERS: FIRST COME . . .

L & J COMPUTERS
3 GRUNDALE AVENUE
KINGSBURY, LONDON NW9 9PJ
01-204 7525

50HZ
SUPERBOARD
£190
(BRITISH STANDARD)
PLUS
OFFICIAL
Dealer Support

PLUS
ASS/ED, EX/MD and other software
and expansion available. Cursor control,
back space etc. Tape Free.

CTS 1 Higher Calderbrook
Littleborough, Lancs OL15 9NL
Tel: Littleborough 0706) 79332 anytime

Vets for Pets

Anite Electronic Services (London) Ltd.
are specialists in the repair and service of
Commodore PETS.

We offer a fast on-site service, or alternatively repairs can be carried out at our
workshops should you wish to bring in
your Pet.

Pet maintenance contracts are available
at very competitive prices. Trade inquiries
welcomed.

For further information, tel or write to:

John Meade
Anite Electronic Services
15 Clerkenwell Close, London EC1
01-253 2444

We also specialise in the repair of all
makes of office equipment.



COMMODORE PET SPECIALISTS

We stock the Commodore
range of equipment and have a
large selection of high quality
software to go with it.

We also have programming
facilities and fast reliable main-
tenance support.

In stock is a selection of second
and ex. demonstration machines all guaran-
teed.

Give us a call first to see what
we have to offer.

DAVINCI COMPUTERS LTD.
Tel: 01-202 8630
Classic Offices
Rear of Classic Cinema
Hendon Central
London NW4.

PET EDITOR

Provides full creation and editing of symbolic text or data files, etc, using

12 POWERFUL COMMANDS including: CREATE, EDIT, FIND, REPLACE, INSERT, MOVE, TAB, etc.
(SAE for full software list.)

On cassette

CIRCLE £20.00
SOFTWARE +VAT

(State old/new ROM + size)

33 Restrop Vt, Purton, Swindon, Wilts. SN5 9DG.

SOUTHAMPTON PET HIRE

Weekly charge: 8K £20, 16K £26.50 plus VAT, inc. manuals, MICROCHESS. Charges count towards any purchase.

BUTTERFIELD'S ENCYCLOPEDIA E12 (inc. VAT and postage. Contains 33 programs on cassette including STARTREK, BATTLESHIPS, LUN LANDER)

Demonstrations of large range of Commodore and Petsoft software Toolkit at £55 + VAT.

See the NEW 8K PET with large keyboard at £495 + VAT. Also 16K, 32K,

Floppy Disk and Printer

£50 free software with purchase of any PET Computer. P.Ex. welcome

SUPER - VISION

13 St James Road
Shirley, Southampton
Telephone (0703) 774023
After hours (0703) 554488

TOPMARK Computers

dedicated to
APPLE II



Simply the best!

Full details from Tom Percy on
Huntingdon (0480) 212563

PROGRAMS

```

● 220 REM ** READ PROGRAM **
● 230 RESTORE
● 240 READ A$
● 250 IF LEFT$(A$,4)<>"PROG" THEN 240
● 260 P=P-1:IF P>0 THEN 240
● 270 FOR L1=1 TO 25
● 280 READ A$
● 290 IF A$="END" THEN 320
● 300 A$(L1)=A$
● 310 NEXT L1
● 320 L1=L1-1
● 330 REM*EXECUTE PROGRAM**
● 340 FOR N=1 TO L1
● 350 IF LEFT$(A$(N),1)="D" THEN 300
● 360 A$=A$(N)
● 370 GOSUB 410
● 380 NEXT N
● 390 GOTO 80
● 400 REM **RECURSIVE SUBROUTINE TO INTERPRET A$**
● 410 I=1
● 420 M=0:AF=0
● 430 IF I>LEN(A$) THEN RETURN
● 440 C$=MID$(A$,I,1)
● 450 IF C$="A" THEN M=A:AF=1:I=I+1:GOTO 430
● 460 IF ASC(C$)<48 OR ASC(C$)>57 THEN 490
● 470 I=I+1:VAL(C$)
● 480 I=I+1:GOTO 430
● 490 IF M=0 AND AF=0 THEN M=1
● 500 REM **SEARCH COMMAND STRING**
● 510 FOR N1=1 TO LEN(C1$)
● 520 IF C$=MID$(C1$,N1,1) THEN 730
● 530 NEXT N1
● 540 REM **MUST BE MACRO**
● 550 GOSUB 970
● 560 PN=PN+1:SN(PN)=N
● 570 IF N=0 THEN A1$=A$:REM IMM MODE **
● 580 FOR N=L1 TO 1 STEP -1
● 590 IF C$=MID$(A$(N),2,1) THEN 610
● 600 NEXT N:PRINT "NO MAJOR":C$:GOTO 630
● 610 A$=MID$(A$(N),3)
● 620 IF S(PA)<=0 THEN 650
● 630 GOSUB 410
● 640 S(PA)=S(PA)-1:GOTO 620
● 650 M=SN(PN):PN=P1-1
● 660 IF N>0 THEN A$=A$(N) ELSE A$=A1$
● 670 IF LEFT$(A$,1)="D" THEN A$=MID$(A$,3)
● 680 I=I+1:PI=PI-1
● 690 PI=PI-1:P1=P1-1
● 700 GOTO 740
● 710 ON X1 GOSUB 770,880,900,910,920,930,
    960,1020,310,111,1190,1210,1230,
    1280,1290,1030,1300,1320
● 720 I=I-1
● 730 IF A>0 THEN 710
● 740 I=I+1:GOTO 420
● 750 REM ** COMMAND SUBROUTINES **
● 760 REM ** FORWARD **
● 770 GOSUB S10
● 780 IF SW=0 THEN 800
● 790 S=S+P:1360:P1=2*(1-P2)
● 800 PLOT X,Y,P1:RETURN
● 810 X=X+DX:Y=Y+DY:REM ** MOVE **
● 820 IF X>M THEN X=M
● 830 IF X<0 THEN X=M
● 840 IF Y>M THEN Y=M
● 850 IF Y<0 THEN Y=M
● 860 RETURN
● 870 REM ** TURN RIGHT **
● 880 DT=DX
● 890 DX=GX(DX+DY):DY=SN(DY-DT):RETURN
● 900 A=A+1:RETURN:REM ** PLUS **
● 910 A=A-1:RETURN:REM ** MINUS **
    
```

PROGRAMS

```

920 RETURN:REM ** SPACE **
930 A2=A:A=A1:A1=A2:REM ** / **
940 RETURN
950 REM ** ( **
960 IF M<=0 THEN GOSUB 1100:RETURN
970 PI=PI+1:P4=P4+1
980 SI(PI)=I:SM(PM)=4
990 I=0
1000 RETURN
1010 REM ** ) **
1020 SM(P4)=S4(PM)-1
1030 IF S4(PM)>0 THEN I=SI(PI):RETURN
1040 IF S4(PM)=-100 THEN I=LEN(A$)
1050 PM=PM-1:PI=PI-1
1060 RETURN
1070 REM ** ? **
1080 I=I+1
1090 IF RND(1)>.5 THEN 1100 ELSE 1120
1100 REM ** T **
1110 I=I+1:IF A<=0 THEN 1130
1120 M=-99:GOSUB 970:RETURN
1130 B=1
1140 I=I+1:C$=MID$(A$,I,1)
1150 IF C$="( " THEN B=B+1
1160 IF C$=")" THEN B=B-1
1170 IF B=0 THEN RETURN ELSE 1140
1180 REM ** HOME **
1190 X=INT((XM+1)/2):Y=INT((YM+1)/2)
1200 PLOT X,Y,P1:RETURN
1210 DX=0:DY=1:RETURN:REM ** NORTH **
1220 REM ** CLEAR **
1230 GRAPH 1:IF P1=2 THEN RETURN
1240 FOR X1=0 TO XM STEP 2
1250 FOR Y1=0 TO YM STEP 3
1260 PLOT X1,Y1,255
1270 NEXT Y1,X1:RETURN
1280 P1=0:SW=0:RETURN:REM ** BLACK TRACE **
1290 P1=2:SW=0:RETURN:REM ** WHITE TRACE **
1300 SW=1:RETURN:REM ** SWITCH TRACE **
1310 REM ** "=,SET A TO NEXT POINT **
1320 X2=X:Y2=Y:GOSUB 810:GOSUB 1340
1330 A=P2:X=X2:Y=Y2:RETURN
1340 REM ** SUBR TO EXAMINE POINT X,Y **
1350 REM ** P2=0 OR 1 FOR OFF OR ON **
1360 XY=62656+INT(X/2)-64*INT(Y/3)
1370 GRAPH 2:P2=PEEK(XY):GRAPH 3
1380 X1=X-2*INT(X/2)+1
1390 Y1=2-Y+3*INT(Y/3)
1400 P2=P2 AND X1*INT(2*(2*Y1)+.5)
1410 IF P2<>0 THEN P2=1
1420 RETURN
1430 DATA PROG 1 HILBERT CURVE
1440 DATA DUT(-V G 5R U 2R G U G 5R V +) 6R
1450 DATA DVT(-J 2R G V G 5R V 2R G U +) 2R
1460 DATA DG3F
1470 DATA DZ HN 23F 6R 30F C F 4R U
1480 DATA A- 4+ Z
1490 DATA END
1500 DATA PROG 2 SPIRAL
1510 DATA SA-999(4(AFR)+)
1520 DATA END
1530 DATA PROG 3 SQUARE SPIRAL
1540 DATA SA-999(AFR+*)
1550 DATA END
1550 DATA PROG 4 SQUARES
1570 DATA DZ 4(AFR)
1580 DATA DX Z 5R 21 3R 4+
1590 DATA CHN=S 999K
1600 DATA END

```

COMMAND SUMMARY

F	Move forward one cell leaving trace (B or W).	+	Increment Accumulator.
		A	Decrement Accumulator.
R	Turn right 45 degrees.		Current value of Accumulator.

MICROMART

COMPUKIT & SUPERBOARD OWNERS EXTRA MEMORY

SMART 2 IS HERE!

Smart 2 is the first in a series of expansion units for your computer.

SMART 2 gives 16K of RAM

SMART 2 is cheap

Send S.A.E. for details

to Mike Dennis, Blackberries
Sheriffs Lench, Evesham, Worcs
Evesham 870841

NORWICH

The computer store that puts you on the right road

Sales, Service and Software

Professional systems and home computers by Compucorp, Commodore and Alder.

Commodore Software, Appointed stockist. Pet Soft Software

COME AND SEE THE PROFESSIONALS

SUMLOCK BONDAN (EAST ANGLIA) LTD
32 PRINCE OF WALES ROAD
NORWICH
Tel NORWICH (0603) 26259

µHex EPROM PROGRAMMERS

426 2508/2708/2758/2516/2716

Dual and Single supply Eproms, £95

416 2704/2708/2716 Dual only, £65

480 2704/2708 Kit £35, Built £40.

All programmers require only standard power supplies.

The 426 & 416 are cased and have push-button selection.

Program any length block into the Eprom. Software included. Range covers 250, 8080, 6800 and 6500. State machine.

PIO, PIA INTERFACE MODULES

Available for 280/8090 and 6800/6500.

Prices include carriage. Please add V.A.T. SAE for further product information.

MICROHEX COMPUTERS

2 STUDLEY REISE, TROWBRIDGE, WILTS.

To advertise in
MICROMART
Please ring Jackie Hancock
on 01-631 1682

FUN & GAMES

Tankbattle

by Kevin Jones

Here is the listing for the PET tank battle mentioned in Young Computer World this month.

```

● 5 FEM
15 REM *** TRAP ***
35 FEM
40 PRINT "ITANK'S PRINT"
50 PRINT "THE OBJECT OF THE GAME IS TO SCORE"
60 PRINT "TEN POINTS"
70 PRINT "YOU MAY SCORE A POINT IN TWO WAYS 'BY'"
80 PRINT "SHOOTING YOUR OPONENT'S TANK OR IF YOU"
90 PRINT "STER ON A MINE * A POINT IS SCORED FOR"
100 PRINT "HIM. A MISSILE WILL FLY OVER A MINE"
110 PRINT "AND DISINTEGRATE ON HITTING AN OUTF"
120 PRINT "WALL IF IT HITS A BARRIER INSIDE THE"
130 PRINT "BOARD AREA. IT WILL HALF DESTROY IT. ON"
140 PRINT "THE NEXT HIT IT WILL RUIN IT TOTALLY."
150 PRINT "EACH PLAYER HAS NINE CONTROLS AS SHOWN"
170 PRINT " E R T      7 8 9
180 PRINT " D F G      4 5 6
190 PRINT " C V B      1 2 3"
200 PRINT "TO MOVE 1 SQUARE IN ANY DIRECTION PRESS"
210 PRINT "THE KEY IN THAT DIRECTION FROM YOUR"
220 PRINT "CENTRE KEY. THE CENTRE BUTTON ITSELF"
230 PRINT "FIRES A MISSILE IN THE DIRECTION OF"
240 PRINT "YOUR LAST MOVE."
250 PRINT "THE LEFT TRAP IS SHOWN AS ●."
260 PRINT "THE RIGHT TRAP IS SHOWN AS ○."
270 PRINT "PRESS ANY KEY TO START " RE"
280 GET # IF #="" THEN 280
290 GOSUB 900 PRINT "3"
300 FOR Y=0 TO 39
310 POKE 32768+Y,227 POKE 32958+Y,228
320 NEXT Y
330 FOR Y=1 TO 19
340 POKE 32768+40*Y,229 POKE 32807+40*Y,231
350 NEXT Y
360 FOR Y=1 TO 19
370 FOR X=1 TO 38
380 P=PNB(1)*10
390 IF R>3,3 AND R<3,75 THEN POKE 32768+40*Y+X,160
400 IF R>3,75 THEN POKE 32768+40*Y+X,90
410 NEXT X,NEXT Y
420 L=V*10 L#3 FV=10 RH=36
430 M#32
440 POKE 33171,81 POKE 33204,97
445 REM *** SETS UP BOARD ***
450 POKE 33661,SL*48 POKE 33675,SR*48
460 IF SL=10 OR SR=10 THEN 940
470 RE"
480 GET # IF #="" THEN 480
490 IF #="C" OF #="" THEN R=-1,D=1
500 IF #="V" OF #="" THEN R=0,D=1
510 IF #="B" OF #="" THEN R=1,D=1
520 IF #="D" OF #="" THEN R=-1,D=0
530 IF #="F" OF #="" THEN R=1,D=0
540 IF #="G" OF #="" THEN R=-1,D=0
550 IF #="E" OF #="" THEN R=1,D=-1
560 IF #="H" OF #="" THEN R=0,D=-1
570 IF #="T" OF #="" THEN R=-1,D=-1
580 IF #="" AND D=0 THEN 470
585 REM *** RECEPTS CONTROL ***
590 IF ASC(#)<60 THEN P=R:R=D:V=F:R#H:P#7:S#L:R#M
600 IF ASC(#)>60 THEN L=R:R=D:V=L:V#L:H#L:P#1:S#R:M#L
610 C=32768+40*Y
620 N=32768+40*Y+V*D
610 IF PEEK(N)>80 AND PEEK(N)<90 THEN 450
620 IF PEEK(N)=32 THEN POKE C,0:POKE N,102:POKE N,160
630 IF PEEK(N)=80 THEN POKE C,0:POKE N,46:H#H#R:V#V#D:O#O#0 GOTO 700
640 H#H#R:V#V#D
650 IF ASC(#)<60 THEN P=V:V#H:SL=S:R#H
660 IF ASC(#)>60 THEN L#V:L#H#H:SP#S:L#H#H
670 GOTO 450
675 REM *** TRAP MOVEMENT ***
680 IF #="" THEN V#V#H:R#R:P#R:D#D:O#O#7
690 IF #="F" THEN V#V#L:H#L:R#L:D#D:O#1
700 C=32768+40*Y
710 N=32768+40*Y+V*D
720 IF PEEK(N)=32 THEN POKE C,0:POKE N,46:H#H#R:V#V#D:O#O#0 GOTO 700
730 IF PEEK(N)=160 THEN POKE C,0:GOSUB 790:POKE N,32:GOTO 450
740 IF PEEK(N)=102 THEN POKE C,0:GOSUB 790:POKE N,102:GOTO 450
750 IF PEEK(N)=80 THEN POKE C,0:POKE N,46:H#H#R:V#V#D:O#O#0 GOTO 700
760 IF PEEK(N)=81 THEN SR#SR#1:POKE C,0:GOSUB 790:GOTO 450
770 IF PEEK(N)=87 THEN SL#SL#1:POKE C,0:GOSUB 790:GOTO 450
780 IF PEEK(N)=200 THEN POKE C,0:GOTO 450
790 REM *** FINDING ROUTE ***
790 Z1=PEEK(N+1):Z2=PEEK(N+1):Z3=PEEK(N+40):Z4=PEEK(N+40)
800 POKE N+1,42:POKE N+1,42:POKE N+40,42
810 FOR TOG TO 50:NEXT TOG
820 POKE N+1,Z1:POKE N+1,Z2:POKE N+40,Z3:POKE N+40,Z4
830 RETURN
835 REM *** EXPLOSION EFFECT ***
840 IF SL=10 THEN #="LEFT"
850 IF SR=10 THEN #="RIGHT"
860 PRINT "*****THE GAME WAS WON BY THE " # " PLAYER."
870 TRAP "*****"
880 IF LEFT(#,1)="Y" THEN GOSUB 900:GOTO 290
890 END
900 #="" R=0:D=0:SL=0:SR=0:L#32:R#32:RETURN

```

MICROMART

Exidy Sorcerer 32k	£765
PET Business Special 32k	£730
PET Dual Floppy Disc	£695
PET Cassette Drive	£45
TRENDCOM Printer	£235
Interface	£40
APPLE 48K	£945
Disc Drive	£390

All exclusive of VAT. All ex-stock. Don't be let down by poor after-sales service and software support.

Mike Dennis, Blackberries,
Sheriffs Lench, Evesham, Worcs.
Evesham 870841

T.S.F.
MICROCOMPUTER
SYSTEMS

DISCOUNT PETS
32Ks @ £675 + VAT
Floppy Units @ £715 + VAT
T.S.F. MICROCOMPUTER SYSTEMS

62 Little Gaddesden, Herts
Tel 044284 2551

TRS-80 System

All items stocked, Barclaycard, Access & American Express are welcome, or apply for your own RADIO SHACK Charge Card. U.K. Delivery by Securicor. Direct and Personal Exports.

RADIO SHACK LTD
188 Broadhurst Gardens,
London NW6 3AY

Tel: 01-624 7174 Telex 23718

SUPERBRAIN

Available now. Demonstrations on your premises. The best value available on the market in small business systems.

64K RAM
320K Dual Floppy

CP/M

£19.50 plus VAT.

ENCOTEL SYSTEMS LTD

Tel: Upper Waringham 5701

Telex: 896559

MICROMART

EPROM PROGRAMMING POSTAL SERVICE FOR 2708 and 2716

From your Hex listing: £9 + VAT (2708)
£18 + VAT (2716)

From your Master Prom: £2.50 + VAT
Editing at pro-rata rates

(Prices include p/p and assume you supply the device to be programmed, we can supply the device however at reasonable extra cost).

WRITE FOR FURTHER DETAILS TO:
Chromatec Video Products Ltd.,
10 Barley Mow Passage, Chiswick,
London W4

SIGMA SYSTEMS

PETs

+

SHARP MZ-80s
(THE NEW MICRO)

+

HEWLETT-PACKARD
HP-41Cs

+

COMPUTER BOOKS

SIGMA SYSTEMS
54 PARK PLACE
CARDIFF 21515

54 PARK PLACE
CARDIFF 21515

D.J.M. SERVICES, 82 Hilden Park Road,
HILDEBOROUGH, KENT, TN11 9BN
Tel: 0732 832816/357721

All prices include postage & VAT
(where applicable)

- BOOKS -

Computer programs that work
(Lee, Beech and Lee) £2.90
Introduction to personal and
business computing (Zaks) £5.00
Microprocessors - from chips
to systems (Zaks) £7.50
Programming the 6802 (Zaks) £8.00
6502 Applications book (Zaks) £9.00
RACAL ZONAL C-12 CASSETTES
Quality you can rely on - screwed shell,
c/w library case and insert card,
5 £3.20; 10 £5.30; 50 £23.90
TDK hard diskette use -
just load like an ordinary cassette, £11.75

TANDY SOFTWARE

Try the quality of Kansas
professionally produced
programs

Free catalogue on request
Return post service - Vat
exempt

Kansas

Unit 3, Sutton Springs Wood,
Chesterfield, Derbys
Tel (0246) 850357
24 hour answering service

BELLS & WHISTLES

Large numeral generator

from a program
by E. G. Kemplen

This routine displays a large numeral as a 6 by 7 matrix of asterisks. Written for PET, it should run on other micros quite easily.

The routine sets up two arrays, A\$ and A in lines 110 to 190. A\$ contains the four elements used to construct the

numeral, while A contains ten sets of codes used to select the appropriate element for each row.

This subroutine will work as it is because line 200 contains an instruction to input the value, X, to be displayed.

```
100 PRINT "0"  
110 DIM A$(7), A$(4), B$(3), S(14)  
120 DATA *****  
130 DATA * * * * *  
140 DATA * * * * *  
150 DATA * * * * *  
160 FOR I=1 TO 4 READ A$(I): NEXT I  
170 DATA 4,4,4,4,4,1,3,3,3,3,3,3,3,1,2,2,1,1,3,3,1,4,4,4,1,3,3,3  
180 DATA 1,2,2,1,3,2,1,1,2,2,1,4,4,1,1,3,3,3,3,3,1,4,4,1,4,4,1,1,4,1,3,3,1  
190 FOR I=1 TO 7 READ A$(I): NEXT I  
200 INPUT "X=": X: PRINT A$(X)  
240 FOR I=1 TO 7  
250 PRINT "*****": A$(I): A$(I)  
260 NEXT I  
270 GOTO 200  
280 REM
```

String routines

by Michael Parr

These routines were designed to run on an Altair system but are intended for any Microsoft-type system - eg Tandy, PET etc.

String Changing

A common operation when working with character strings is to change part of a string, leaving the rest unaltered. For example, to change "COMPUTOR" to "COMPUTER" the operation can be specified as replacing "TO" by "TE". If we were imprecise, and just altered "O" to "E" then the result would be "CEMPUTER".

Some versions of BASIC have a statement of the form:

CHANGE F\$ TO T\$ IN L\$

which automatically does the replacing. One may write:

```
10 L$ = "COMPUTOR"  
20 CHANGE "TO" TO "TE" IN L$  
30 PRINT L$
```

where COMPUTOR is printed.

This is fine, but the commonly available Microsoft BASIC does not include such a statement. However, do not despair.

Fig 1 gives the listing of an equivalent subroutine. The calling sequence must set L\$ to the string to be changed, F\$ to the section of L\$ to be changed, and T\$ to the new version of F\$. As an example, the above operation is performed by:

```
10 L$ = "COMPUTOR"  
20 F$ = "TO": T$ = "TE"  
30 GOSUB 1200  
40 PRINT L$
```

Note:

a. It is possible to delete characters by setting T\$ to a zero length string, thus: 20 F\$ = "A": T\$ = "": GOSUB 1200 would remove every letter "A" from L\$.

b. If F\$ is not found in L\$, the subroutine does not change L\$. However, an error may result if an attempt is made to extend L\$ beyond the maximum possible length (usually 255).

The subroutine has a variety of uses:

a. The addition of some ten lines results in a simple file editor (fig 2), which has proved useful in converting programs written for different BASIC systems, which may use for example "instead of", and may need an argument for RND, i.e. RND(1).

b. A word processing system requires the facility to alter all occurrences of a word to a different word. By the inclusion of spaces in F\$, one can ensure that complete words are selected for alteration, as opposed to parts of a word.

c. The routine has been used as the heart of a simple macro-processor, taking up some 80 lines of BASIC.

An INSTR Routine

Frustrated Pet users will have realised that, though their BASIC includes LEFT\$, RIGHT\$, and MID\$, the INSTR function (which locates the position of a substring within a string) is missing. Fortunately fig 3 lists a subroutine which exactly simulates the Altair INSTR function. It has been intentionally written in "simple" BASIC to aid implementation on a range of systems.

The routine takes F as the starting position of the search, and examines L\$ for an occurrence of F\$. The position is set in P\$, and is zero if F\$ is not found.

To produce the effect of:

```
1230 P$=INSTR(F,L$,F$,F$)  
use:  
1230 GOSUB 2000
```

BELLS & WHISTLES

①

```

1200 REM ** CHANGE F# TO T# IN L# **
1210 REM USES $#, L1, F, P#
1220 F#1
1230 P# = INSTR(F, L1, F#)
1240 IF P# = 0 THEN RETURN
1250 S# = L#
1260 L1 = LEN(L#)
1270 IF L# = F# THEN L# = T# RETURN
1280 IF P# + LEN(F#) = L1 + 1 THEN L# = LEFT$(L#, P# - 1) + T# GOTO 1310
1290 IF P# = 1 THEN L# = T# + RIGHT$(L#, L1 - LEN(F#)) GOTO 1310
1300 L# = LEFT$(L#, P# - 1) + T# + RIGHT$(S#, L1 - P# - LEN(F#) + 1)
1310 F# = P# + 1 : L# = L#
1320 GOTO 1240
1330 REM SUB END
    
```

②

```

TO REM FILE EDITOR
20 CLEAR 500 - ENSURE ENOUGH STRING SPACE (ONLY NEEDED ON PET)
30 INPUT "WHICH FILE TO EDIT?"; A$
40 INPUT "NEW FILE?"; B$
50 REM OPEN "INPUT" AND "OUTPUT" FILE.
60 OPEN "I:" + A$ : OPEN "O:" + B$
70 LINEINPUT "ALTER ALL. "; F$
80 LINEINPUT "TO "; T$
90 REM EDIT ALL FILE
100 IF EOF(1) THEN END
110 LINEINPUT I1; I$ : GOSUB 1200
120 PRINT I2; I$ : GOTO 100
    
```

③

```

2000 REM INSTR(F, L#, F#) - RESULT IS P#
2010 REM F# USED
2020 F# = INT(F)
2030 IF F# = 0 THEN 2050
2040 PRINT "L1: L# OF INSTR " STOP
2050 IF LEN(L#) = 0 THEN 2120
2060 IF LEN(F#) = 0 THEN 2120
2070 IF LEN(L#) < LEN(F#) THEN 2120
2080 IF F# > LEN(L#) - LEN(F#) + 1 THEN 2120
2090 FOR P# = F# TO LEN(L#) - LEN(F#) + 1
2100 IF MID$(L#, P#, LEN(F#)) = F# THEN 2130
2110 NEXT P#
2120 P# = 0
2130 RETURN
    
```

NAMING NASCOM FILES

by J. Dartnell

Although the basic NASCOM 1 (T2) Monitor is quite powerful it does not have any facilities for dumping and loading named tape files. This routine (within the confines of the memory available) is designed to provide the facility of named tape files, thus allowing several programs (particularly sub-routines) to be stored on one tape and recalled by a search. Tape positioning for cassette recorders without footage counters is also possible.

The routine is executed from 0F15 and with data areas occupies 0EF8 - 0FE0. This means a file can occupy 0C50 - 0EEF and leaves 0FE1 - 0FFF available for the stack in the basic system.

There are two restrictions in its use.

Example 1

To dump a file extending from 0C50 to 0EEF called TESTFILE.

```
>EF15 N/L
F? TESTFILE
```

```
C? M
0EF8 XX 50 0C F0 0E. N/L
```

C? D

Enter filename (8 bytes maximum) terminated by full stop. Full stop is not repeated on the screen.

M - modify dump addresses. Enter M only. Enter data as usual under Monitor MODIFY. Note that the addresses are reversed i.e. 0C50 is entered as 50 0C.

D - dump file. The cassette motor should be started before entering D as the routine starts the dump immediately. Any spurious characters generated by switching on the cassette motor are

Firstly, dumped data cannot have an address higher than 0EEF in the basic system. Secondly, the Monitor LOAD routine will (as usual) overwrite memory with the contents of any intermediate files.

Three commands are available within the routine:-

1. Modify the addresses of the area of memory to be dumped, command character M.

2. Dump the area of memory specified by the addresses set up by M, command character D.

3. Load the file specified, command character L.

The maximum length of the file name is 8 bytes.

MICROMART

ANADEx DP80000
£520 EX STOCK

Add £10 carriage 15% VAT
Cash with order

MICRODATA

58 High Street, Prescot,
Merseyside L34 6HQ
Tel: 051 426 7271

MICROS BOUGHT,
SOLD OR EXCHANGED.

MICROHIRE

SOME BELOW £14/WEEK
MONEY BACK ON PURCHASE.
FREE DELIVERY & COLLECTION
IN LONDON.

SMALL CHARGE OTHERWISE.
APPLE, PETS, SOCCER, HORIZON,
PRINTERS, FLOPPY DRIVES.

SALE NOW ON

APPLE 32K ONLY £700
(CENTRONICS T/F 779) £700
HORIZON 32K D/D £1,200
PAPER TIGER £540

COMPLETE CHALLENGER SYSTEM
WITH 2 DISK DRIVES ONLY
£900

PET 8K ONLY £400
APPLE DISK DRIVE ONLY £340

PHONE US FOR OUR LATEST OFFERS
MONDAY - SUNDAY
BEST TIME EVENINGS
01-368 9002

NEW

MICROTYPE
SERIES 80
MICROCOMPUTER CASE



Ready Cut for Superboard or UK101
Complete with screws and instructions
Also available with uncut keyboard for homebrew
enthusiasts. Produced in strong, black ABS plastic.
Please state type when ordering.
ONLY £15.95 + VAT Post and packing inclusive.
Send Cheque or Postal Orders to
Microtype, PO Box 104, Hemel Hempstead,
Herts HP2 7QZ SAF for Details
C12 BRANDED DIGITAL QUALITY CASSETTES
100m Magnetic tape and index card 10 for 38p ea + VAT
Serial £2.40 including UK and VAT

CASH & CARRY

- * PET 2001 8K & 32K
- * PET Serial Interfaces
- * PET Parallel Interfaces
- * PLESSEY 24(32)K Memory
- * CENTRONICS 779 Printers

Also some ex-demo/hire
units available.

(with full warranty).
Phone John Handy, 042 050 374.

MICROMART

SHARP MZ-80K
from £520 plus VAT



Sharp agents for N.W.Kent.

Free demonstrations at your premises in that area.

PET HIRE from £4.25/day
Essex Computer Services

Tel: Canvey Island (03743) 61663

DISCOUNT PETS

Latest 8K with large keyboard, £475,
16K £560, 32K £650

Dual floppy E680 BASE2 printer £450

PROGRAMMERS TOOLKITS £45

CHALLENGER 1 4K £223,

complete with RF converter.

++TEXAS TI 99/4 £890++

with 13" colour monitor

The most advanced home computer,
delivery March, order now.

AIM65 4K, cased, powered,

Basic £420

SEAWELL expansion chassis,
memories etc.

S-100 16K FULLY STATIC

MEMORY 2MHz assembled and tested
£150

COMPLETE S-100 SYSTEM

with Z-80 CPU, North Star double-
density disk, 32K static memory

£1200

Also other S-100 products

Full technical support

from MAPCON engineers.

Phone in case prices have fallen.

VAT extra

INTELLIGENT ARTEFACTS

Cambridge Rd, Orwell, Royston Herts

Tel: Arrington (022020) 689

PETS!

Pets - new for old, part exchange
your faithful Pet for a new model.

We stock Commodore or

Computhink discs, PET printers and

teletypes etc.

We also buy used Pets and

peripherals for cash.

HORIZONS!

32K static memory (the best) 2 double
density discs (2 serial and 1 parallel
port) from £1999

HIRE!

PET 8K £4.75 per day

PET 32K £6.95 per day

Teletype 43 £6.00 per day

HORIZON P.O.A.

HIGH QUALITY CASSETTES!

C15 41p C30 55p including VAT

Post 20p

Orders over £4.00 free postage

Contact

Richard Mortimore or Chris Phelps

at

MICRO - FACILITIES

01-979 4546/941 1197

PROGRAMS

ignored as the routine only accepts M, L or D at
this stage.

Header dumped.

File dumped.

Finished. N.B. N/L may be required here.

Return to Monitor

Example 2

To load a file named TEST2

>E15 N/L

F? TEST2

C? L

Enter file name terminated by full stop.
L - load. Enter L only. Switch on motor. Monitor
LOAD information with scroll if checksum
incorrect.

Finished return to Monitor

OP08 XX XX					start and end
OP0A XX XX					addresses for dump
OP0C XX XX XX XX XX XX XX XX					file name
OP04 XX XX XX XX XX XX XX XX					file name dumped/
OP0C XX XX XX XX XX XX XX XX					loaded
OP14 XX					finished indicator
OP15 AF	FSRCH:	XOR A			clear A
OP16 21 FC 0E		LD HL,OPCC			clear file name
OP19 11 FC 0E		LD DE,OPCC			buffers
OP1C 06 19		LD B,19H			and finished
OP1E 12	CLEAR:	LD(DE),A			indicator
OP1F 33		INC DE			areas
OP20 10 FC		DJNZ,CLEAR			
OP22 3F		RST 40			output string
OP23 1E 46 3F 20 00		TEXT			clear screen F70
OP28 CD 3E 00	CHAR:	CALL CHIN			get a character
OP2B FE 2E		CP 2E			full stop?
OP29 2B CD		JNZ,COMM			get command
OP2F FE 1D		CP,1D			backspace?
OP31 20 04		JNZ,BACK			then backspace
OP35 77		LD(HL),A			dump
OP34 23		INC HL			next pointer
OP35 14 01	BACK:	JR,LEFT			display character
OP37 2B		DEC HL			scrub character
OP38 CD 3B 01	LEFT:	CALL CHC			display character
OP3B 1E 3D		JR,CHAR			get another character
OP3D 3F 1F	COMM:	RST 40			output string,scroll
OP3F 43 3F 20 00		TEXT			C70
OP43 CD 3E 00		CALL CHIN			get command character
OP46 FE 4D		CP 4D			M-modify?
OP48 20 11		JNZ,FDMP			try D-dump
OP4A CD 3B 01		CALL CHC			display
OP4D 3F 1F 00	FWCD:	RST 40			output string scroll
OP50 21 86 0E		LD HL,OP08			start address
OP53 22 0C 0C		LD(CC,CC),HL			set up modify argument
OP54 CD 41 01		CALL MODIFY			monitor modify
OP59 1B 82		JR,COMM			get another command
OP5B FE 44	FDMP:	CP 44H			D-dump?
OP5D 20 31		JNZ,FLD			try-load
OP5F CD 3B 01		CALL CHC			display character
OP62 21 FC 0E		LD HL,OPCC			transfer file name
OP65 11 0C 0F		LD DE,OPCC			to file name
OP68 01 08 00		LD BC,00			dump
OP6B 02 30 00		LDIR			area
OP6D 00		NOP			padding
OP6E 00		NOP			padding
OP6F 22 0C 0C		LD(0000),HL			dump arg 1
OP72 8D 53 0E 0C		LD(000E),DE			dump arg 2
OP76 CD 01 0F		CALL SROMF			dump file number
OP79 06 FF		LD B,FFH			S=255
OP7B CD 33 00	DELAY:	CALL XDEL			monitor delay
OP7E 10 7B		DJNZ,DELAY			delay, for reading
OP80 2A F6 0E		LD HL,(OP08)			set up file
OP83 22 0C 0C		LD(000C),HL			dump arg 1
OP86 2A FA 0E		LD HL,(OP0A)			set up file
OP89 27 0E 0C		LD(000E),HL			dump arg 2
OP8C CD 01 0F		CALL SROMF			dump file
OP8F 1B 29		JR,LFIN			finished
OP91 FE 4C	FLOAD:	CP 4CH			L-load?
OP93 40 48		JNZ,COM			try again
OP95 CD 3B 01		CALL CHC			display
OP98 3F 1F 00		RST 40			string scroll
OP9B 4D 01 FC 0E	AGAIN:	CALL SLOAD			call load routine
OP9E 11 FC 0E		LD HL,OPCC			set up for
OPA1 21 0C 0F		LD HL,OPCC			comparing
OPA4 04 0E		LD B,0E			file number
OPA6 1A	COMP:	LD A,(DE)			compare
OPA7 BE		CP A,(HL)			bytes
OPA8 20 06		JNZ,READ			no-match
OPAA 04 0E		INC HL			move
OPAB 13		INC DE			pointer,s
OPAC 10 F6		DJNZ,COMP			repeat
OPAD 3E 01		LD(HL),01			no.cad
OPB0 CD 01 0F	READ:	CALL SLOAD			read file
OPB3 3F 01 0F		LD A,(OP14)			load finished indicator
OPB6 FE 01		CP A,01H			finished?
OPB8 20 E1		JNZ,AGAIN			ignore if wrong file
OPBA 3F 1F 00	LFIN:	RST 40			string scroll
OPBD 00		NOP			padding
OPBE 03 39 05		CP,PARSE			return to monitor
OPC1 21 CA 0F	SLOAD:	LD HL,OPCC			set up
OPC4 27 4E 0C		LD(004E),HL			return addresses
OPC7 03 FC 03		JP LOAD			jump to load routine

PROGRAMS

● OFCA 21 09 00	LD HL,00 09	restore 0.spl.1
● OFCD 22 4E 00	LD (004E),HL	jump
● OFCE 09	RET	return
● OFD1 0D D1 03	SDIM: CALL DUMP	monitor dump
● OFD4 3F 1F	RTD 40	string scroll
● OFD6 3e 2E 00	EXIT	>
● OFD9 09	RET	return

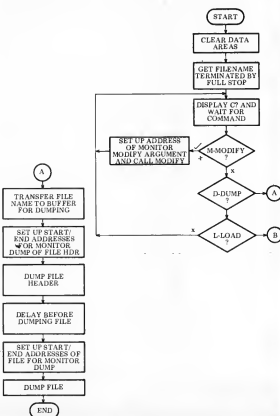
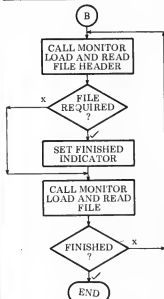

LEISURE LINES

With J.J. Clessa

Another good response — over 80 entrants — indicates that Puzzle 4 was not all that difficult (particularly for those of you with micros, programmable calculators, or use of OPCs — that's Other People's Computers).

In fact, I judge that the hardest part of the problem was actually fitting the answers onto a postcard, as requested; we even had one or two of the giant, home made variety.

The first correct entry selected out of the bag came from Mark Dobby of Christchurch in Dorset; he will be receiving through the post, the promised bottle of Bollinger extra quality, very dry, special cuvee champagne. His answers (which are not unique — in fact there are an infinite number of answers to each part of the question) are as follows:

(a=2) 105263157894736842
 (a=3) 1034482758620689655172413793
 (a=4) 102564
 (a=5) 102040816326530612244897959183673469387755
 (a=6) 1016949152542372881355932203389830508474576271186440677966
 (a=7) 1014492753623188405797
 (a=8) 1012658227848
 (a=9) 10112359550561797752808988764044943820224719

(I just hope the typesetter isn't too full of party spirit when this page is being set!)

THE QUICKIE

Okay, eyes down for a quick one (a real "cringer", I'm afraid).

Two English coins add up to 55 pence. One is NOT a 50p piece. What are they?

PRIZE PUZZLE

This month's problem shouldn't prove too difficult. Find the smallest perfect square that is also the average of two other perfect squares. In other words, find three perfect squares —

$$a^2, b^2 \text{ and } c^2 \text{ — such that: } b^2 = \frac{a^2 + c^2}{2}$$

By the way, for all you smart alecs out there ... $a \neq b \neq c$.

Answers please on a postcard to: Puzzle No.6, Personal Computer World, 14 Rathbone Place, London W1P 1DE. All solutions must arrive by February 12 the latest.

PRIZE FOR THIS MONTH

Prepare yourself for Spring ... for this month's lucky person there'll be a folding umbrella (male or female variety — depending on the gender of the winner).

MICROMART

Logic box

STOP MAINS INTERFERENCE

Is mains interference a problem?
 We stock the well tried BLL-Voltage Suppressor. Handles 1500 watts at 6 amps and reduces interference between 150KHz and 100MHz
 £19.00 inc. VAT and pp

We stock a full range of computer accessories including printers, disk drives, cassettes, diskettes, stationary, books, and computer furniture.

... drop in, we are open Mon-Fri 9.30-6.00...
 by Caxton Hall and St. James Park tube

LOGIC BOX, 31 Palmer st.,
 LONDON SW1H 0PH
 Tel: 01-222 1122
 also at Planer Bldg. Windmill Rd.,
 Sunbury, Middx
 Tel: Sunbury 86262

SYSTEMSCRIBE

SMALL SYSTEMS SOFTWARE

Programming is a logical procedure: logical programming begins with coding sheets SYSTEMSCRIBE Coding Sheets, designed to be usable with most languages, are ideal for the microcomputer programmer (whoever does the key-inning will appreciate them too!)
 Pads of 50 sheets: 25 x 80 format.
 3 pads for £4.50 (including VAT and postage).

SYSTEMSCRIBE LIMITED
 62 Daws Heath Road, Thundersley, Benfleet
 Essex SS7 2TA

ATTENTION SUPERBOARDERS! QUALITY LOW-COST SOFTWARE FOR SUPERBOARD II and CHALLENGER 1P

Cassette containing 4 games:
 HANGMAN - over 100 words, stored in code to avoid accidental display.
 MOONLANDING - three levels of skill, position plotted on screen.
 TANK BATTLE - two player game with full control from keyboard.
 BATTLESHIPS - game of tactics against the computer, 10 by 10 board.

All games make full use of graphics and run on unmodified SUPERBOARD II with 4K memory. Supplied on cassette, all 4 games for £6.75 inc. — you could pay this much for one program alone!
 SEND NOW to:
 AB Software, 7 South View, Springfield Rd.,
 Elburton, PLYMOUTH PL9 9PS.

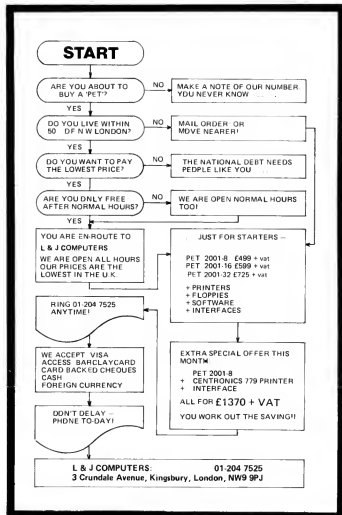

Happy Memories

21102	450ms	83p	16K Memory Upgrade Kits for TRS-80, Apple and Sorcerer all at £64.00	
21102	250ms	4.00		
2114	450ms	4.95	Vero S100 Products:	
2114	250ms	5-45	6 Slot Card Frame with Power Supply	241.36
4116	300ms	7-25	Prototyping Cards (3 types) each	13.66
4116	150ms	7-75	Extender Card	21.70
2708	450ms	7.26	Motherboard with 6 connectors	67.65
2716	450ms	23.50		

IC Sockets:			Ithaco InterSystems Products:	
Fins Solder	W/W		S100 280 CPU Card 4ME: AAT	176.61
8	10p	24p	" " " 281a "	150.94
14	11p	36p	" " " Bare Board	30.19
16	13p	39p	S100 Video Display Board AAT	125.06
18	16p	46p	" " " Bare Board	21.56
20	17p	58p	S100 16 x 2708/2716 AAT	73.31
22	19p	61p	" " " Bare Board	21.56
24	21p	63p	S100 Proto Board (Plated Through)	21.56
26	27p	70p	See Ithaco's own advertisement for full range	
40	37p	109p	VERBATIM Mini-Dance (Pet, TRS-80 etc)	10 21.50
8A5050		17.75	Cannon MIN-D 25 way connectors: Female	1.65
8A5020		7.99	Male 1.45	Hoods 57p Other sizes available
81L895		1.50	DIN 41612 Euroconnectors 64 way: Female	3.17
81L897		1.54	Right-angled Male 1.93	Other sizes available
7415 series:			DIP Switches: 4, 7 & 8 way all at	85p

We stock a full range of wire-wrapping equipment and supplies for you to choose from; we have shelves of books - give us a ring with your requirements and avoid crippling postage charges. Our stocks are too numerous to list here - free price lists sent upon request.

The shop is open from 10 until 6 Monday to Saturday and is worth a visit to catch a surplus bargain - Keyboards at 39.50 today, we may have some left when this gets to print 7 18 slot S100 Motherboards at 22.50 7 Double Barocard prototyping boards for a pound. ALL PRICES INCLUDE VAT. POSTAGE FREE ON ORDERS OVER 10 POUNDS IN VALUE. ORDERS ARE 25p. ACCESS AND BARCLAYCARD WELCOME. YOU MAY TELEPHONE WITH YOUR CARD NUMBER AND REQUIREMENTS. TRADE ACCOUNTS ON APPLICATION. GOVERNMENT & EDUCATIONAL ORDERS WELCOME £10 MIN.

**19 Bevois Valley Road, Southampton,
Hants. SO2 0JP Tel: (0703) 39267**

DATRON of SHEFFIELD

nascom

Full nascom range (including printer)

See them in operation and buy them at DATRON

Demonstrations.
9am-5pm Monday-Saturday.

Call anytime - no obligation - or by mail order.

Delivery free anywhere in the U.K.

DATRON MICRO CENTRE
DATRON INTERFORM LTD

Latham House, 243 London Road, Sheffield S2 4NF.
Telephone 0742 - 585490. Telex 547151.

NB**NewBear
Components****MICROCOMPUTING I.C.'s**

Z8001	£142.50
MC6800	£ 7.15
MC6802	£ 8.50
MC6821	£ 4.63
MC6850	£ 6.74
MC6810AP	£ 3.61
MC6840	£ 12.72
MC8602P	£ 2.88
MCI4536P	£ 3.69
MC3459	£ 2.43
Z80 CPU 2.5MHz	£ 8.99
Z80 P10 2.5MHz	£ 7.99
Z80 CTC 2.5MHz	£ 7.99
Z80A CPU 4MHz	£ 13.99
Z80A P10 4MHz	£ 10.00
Z80A CTC 4MHz	£ 10.00
SCJMP 11	£ 8.88
1NS 8060N	
1NS 8154N	£ 8.18
8080A	£ 6.00
6502	£ 12.00
6522	£ 6.58
6552	£ 12.56
6545	£ 16.66
6551	£ 10.79

MEMORIES

2708	£6.99
4116 (16K DYNAMIC)	£6.99
2102-1	£0.85
2102-1L	£0.99
2112	£2.25
2114	£6.99
2716 (INTEL)	£21.50

**SHARP
MZ 80K
at NEWBEAR****\$100 BUS**

8 Slot Motherboard	£ 32.00
12 Slot Motherboard	£ 38.00
20 Slot Motherboard	£ 45.00
Z80 CPU Board	£ 26.75
Z80 CPU Board Ass. 4MHz	£13.75
Z80 CPU Board Ass. 2MHz	£131.25
V.D.U. Board	£ 18.75
V.D.U. Board Assembled	£108.75
Floppy Disc Controller Board	£ 26.25
Floppy Disc Controller Board Ass.	£131.25
2708/2716 E-prom Board	£ 18.75
2708/2716 Eprom Board Assembled	£ 63.75
8K Static Ram Board	£ 18.75
8K Static Ram Board Ass. 250 NS	£146.25
8K Static Ram Board Ass. 450 NS	£123.75
Prototype Board	£ 18.75

77-68 Prices Slashed!

Bearbag 1	77-68 CPU KIT	£35.00
Bearbag 5	77-68 4K RAM KIT	£55.00
Bearbag 6	77-68 MON 1 KIT	£37.50
Bearbag 12	77-68 V.D.U. KIT	£42.50
Bearbag 13	77-68 MON 2 KIT	£47.50
Bearbag 16	77-68 EPROM BOARD KIT	£21.50
Bearbag 17	77-68 PIO BOARD KIT	£40.00
Bearbag 23	77-68 32K DYNARAM KIT	£75.50
Bearbag 18	CASSETTE INTERFACE	£12.50

- ★ SUPERBOARD II £188
 - ★ 610 EXTENSION BOARD £188
 - ★ FLOPPY DISC DRIVE £312
- (includes DOS, 12K Basic, Case & PSU)

NASCOM II £295.00

- ☆ 2K GRAPHICS ROM £15.00
- ☆ POWER SUPPLY £29.50

VERO

SEND FOR LIST OF VEROBOARDS, BOXES AND INTERCONNECTING SYSTEM

ACORN

6502 BASED MICRO KIT	£65.00
8K RAM KIT	£95.00
MAINS ADAPTOR	£ 5.00
V.D.U. KIT	£88.00

**NEWBEAR SYSTEMS FOR APPLE II,
HORIZON AND SHARP.**

TERMS: Credit Sales (minimum £10.00) Barclaycard and Access Welcome. Please add 15% VAT.
SEND FOR OUR BOOK LIST
AND NEW FULL CATALOGUE

CALLERS AND MAIL ORDER: 40 Bartholomew Street, Newbury, Berks. Tel: 0635 30505

CALLERS ONLY: 220-222 Stockport Road, Cheadle Heath, Stockport Tel: 061 491 2290

Intex DATALOG LTD COMPUTERS

MAIL ORDER DEPARTMENT
CASH WITH ORDER ONLY

ALL GOODS DESPATCHED BY RETURN OF POST OR YOU
WILL BE NOTIFIED OF ANY DELAY & OFFERED AN
ALTERNATIVE OR THE RETURN OF YOUR MONIES

PET	495.00	DISKETTES	30.00
2001-8	675.00	PET 3040 PER 10	30.00
3016	795.00	APPLE PER 10	35.00
3032	55.00	C/THINK O/D Pk... J	
C2N CASSETTE DECK	25.00		
IEEE TO IEEE LEAD	20.00	OEMAGNETISERS	4.00
PET TO IEEE LEAD	795.00	CURVED HEAD (MAINS)	12.00
3040 DISK		CASSETTE (BATTERY)	
COMPUTHINK 400K	825.00		
FOR 8K VIA EXP/PET	895.00	WORKBOOKS	
FOR 16/32K	1145.00	T15 WORKBOOKS (NO VAT) 18.00	
800K UNIT	320.00	SET OF 6	
24K EXPANDAPET			
		CONNECTORS	1.25
INTERFACES	120.00	PET USER/IEEE PORT	.95
SMALL SYS. SERIAL C	175.00	PET 2NO CASS PORT	2.50
SERIAL B BI-OIR	165.00	COVERS FOR USER/IEEE	2.50
TNW2000 BI-DIR		PORT CONNECTOR	
ALL IEEE/RS232	166.00	O25 RS232 CONNECTORS	3.25
PETSET 1 A/O		MALE/FEMALE	2.50
STOCKISTS OF PETSOFT &		COVERS	
COMMODORE SOFTWARE			
		KIM	99.95
PAPER	2.50	KIM 1	129.95
TCM100 ROLL	15.00	KIM 3B	69.95
ANADEX/PET 80COL	25.00	KIM 4	
TELETYPE 132 COL			
PR-40 ROLL	1.00	NASCOM	125.00
		NASCOM 1 (KIT)	140.00
CASSETTES		NASCOM 1 (8BULT)	295.00
C15 CASS HIGHGROAE	4.00	NASCOM 2 (KIT)	29.50
PER 10 IN LIBRARY CASES		POWER SUPPLY (KIT)	

SEND FOR OUR FULL SOFTWARE & MAIL ORDER PRICE LIST

MAIL ORDER DEPT
EAGLESCLIFFE IND EST
EAGLESCLIFFE, CLEVELAND TS16 0PN
TEL 0642 781193 TELEX 58292

ALL PRICES ARE EX. VAT.
PLEASE ADD 50P P&P ON SMALL ITEMS
2.50 P&P ON LARGE ITEMS

Intex

New from Millbank!



Qume Sprint 5 Daisywheel Printers.

These high quality 45/55 KSR and RO
printers are now available at attractive
OEM prices — from **£1389.00** (excl. VAT)

SPECIAL OFFER.....

Teletype 43 Pin and Friction,
only **£790.00** (excl. VAT)

We also have a complete range of Ohio Scientific
hardware — ex-stock or for early delivery.

Ring or write for details
MILLBANK COMPUTERS LIMITED
East Lane, Kingston upon Thames, Surrey Telephone: 01-549 7262

Possibly the most cost effective word processors in the world.



The Vector Graphic MZ

- *4MHz 280A CPU
- *48K ram
- *830K Bytes disk storage
- *Serial port and two parallel ports
- *Prom/ram Board with monitor
- *MDOS Operating system
- *Z80 Assembler
- *Basic Interpreter

Plus a large range of CP/M compatible software
including Fortran, Cobol, Macro assemblers etc.

ALMARC
DATA SYSTEMS LTD

The Vector Graphic System B

- Complete Vector MZ system plus: *
- *Vector Mindless terminal *
- Flashwriter 2 video board (24 x 80) *
- *Software driver on prom *
- MZOS North Star compatible DOS *
- *CP/M configured by Almarc *

906 Woodborough Road, Nottingham. Telephone: (0602) 625035

Buy here at discount prices!

- ☆ Full after-sales service in our own workshops
- ☆ One year guarantee on all machines

Save money.

Improve your 8K PET with memory expansion boards internally mounting, full instructions supplied, plug and socket connections only.

24K £249

24K to support disc drives £320
32K to support disc drives £432



Free Installation

You can afford to start computing now!

— with the Ohio CI-P

*Powerful programming possible — 6502 processor, fast 8K Microsoft floating point BASIC (easy to learn), Superior utilities, 53 key keyboard, giving upper and lower case, user definable keys, gaming and graphics chs.

Ultra-fast and powerful machine code from keyboard.

*No intricate soldering or metal work. Computer supplied programmes in 4K RAM. *Expandable to 24K RAM in case, drives discs, printer; available items include Assembler/Editor and Extended Monitor. *Programme interface character format 24 rows by 24 ch. *Save programmes on own cassette recorder — all cables supplied.

Add £24 for converted model, Extra 4K RAM £38



— at a lower price than equivalent kit!

£199

As imported, fully tested, complete with 4K RAM, but unconverted to UK std. (Conversion instructions supplied).

Credit terms available

Get into print this easy way!

Fast! Immaculate! Silent!



Anadex DP 8000 dot-matrix printer

*Speedy 112 ch/s bdr
*Fits A4 paper — up to 80 cts
*Up to 4 copies *Precision form-filing with sprocket feed
*Special headings using double width chars. *Modern paper format to match A4 sizing systems *Other paper sizes with adj. sprocket
*Full punctuation, U/L case, E sign, 56 ch. set
*Reliable — strongly built, 100 M ch. head

Knock down price!

£499

Interfaces — Pet £45 Ohio £10
TRS-80 £12 Sorcerer £6 Apple £69



IBM golfball printer ideal for word-processing

*Forget expensive Spin Wheel printers — the Golfball produces equal quality at up to 15 ch. per sec. *Match various typewriter styles with IBM interchangeable heads. *Completely reliable — each machine rebuilt by IBM trained engineers and fully guaranteed *Precision form-filing possible with 15 in. pin feed platen.

Limited supply!

£595

Interfaces — Pet £45 Ohio £10
TRS-80 £12 Sorcerer £6 Apple £69



Trendcom 100 thermal printer

*Stop disturbing others with noisy printers! *Near, clear, 96 ch. set, U/L case 6 symbols
*Matches Pet/Apple line lengths *Fast, 40 ch/s bdr *Reliable — robust — only two driven parts.
*Plug in and go, built in PSU, detailed manual *Thermal paper 4 1/2 in wide x 80 ft, less expensive than electro-sensitive paper

A snip!

£249

Interfaces — Pet £45 Ohio £10
TRS-80 £12 Sorcerer £6 Apple £45

While stocks last

PET



NEW 2001-8N

(8K RAM
New large keyboard)

£499

2001 — 16N (16K RAM and new large keyboard) £590
2001 — 32N (32K RAM and new large keyboard) £690
External cassette deck, suitable for all Pets £53
CBM dual drive mini floppy £745
CBM tractor feed printer with Pet graphics £605

Converted to UK frame sync.
(no wobbly display)
— no one else does it!

Make PET talk to the outside world

IEE/RS232 serial i/f input/output £140
IEE/RS232 serial i/f output £80
Pet to S100 4-slot motherboard £112
Pet to TV improved adaptor — connects to serial socket £25

IEE/Centronics parallel i/f

£45

COMPUTERAMA

LTD.

Tel: Bath (0225) 28819

Your dealer for Bath, Bristol and S.W.

Please add £10
Service delivery
on computers etc
plus 5% VAT
on all prices

Computerama Ltd.
Harpers Kensington
Showrooms
London Rd, Bath, Avon



Credit card orders accepted by telephone for immediate despatch.

MEET THE LITTLE GENIUS

If you find self-instruction manuals difficult to follow then meet our Little Genius.

Little Genius floppy diskettes are the fastest, easiest way to master your micro.

Little Genius will save you time and effort, teaching you to exploit all your micro's facilities.



Courses on Basic and Advanced Basic are available now for the Apple 2 and the ITT 2020. Courses for the Pet and the TRS 80 will be available shortly.

For a free demonstration or more information, ask your local dealer or contact Peter Brown at Suite 504 Albany House, 324 Regent Street, London, W1R 5AA. Telephone 01-580 6361.

You've heard about it
Read about it — HERE IT IS

AVAILABLE EX-STOCK
COMPLETE KIT AS PER
MANUFACTURER'S SPECIFICATION
With provision for 8K on board expansion. Excludes 4118 x16+

INCLUDES FREE 16K EXPANSION
VAT 15% FREE

NASCOM-2
ON DEMONSTRATION NOW

£295 + 15% WITH
VAT FREE
16K EXPANSION WORTH £140

AVAILABLE ONLY FROM US ON THE COUPON BELOW

OPTIONAL EXTRAS
3 AMP POWER
SUPPLY VAT 15%
£29.50 Post + 1.50
For NASCOM-2

8 OFF 4118+
For NASCOM-2
Purchasers
£80 Early
Delivery

RS232 COMPATIBLE

80 COLUMN PRINTER

brand new
Last price £550 If sent by carrier £5 extra

OUR PRICE
£325 + VAT
15%

FULL MANUFACTURER'S WARRANTY — DON'T DELAY. ORDER TODAY

Please send me my NASCOM-2 KIT with the FREE 16K EXPANSION for £295 + VAT.

I enclose remittance

to cover

Name & Address

Also in stock NASCOM-1 • ELF • TRS80 as previously advertised



Henry's

Computer Kit Division
404 Edgware Road, London, W2, England
01-402 6822



The complete range
of computer systems under one roof

**Commodore
System**



HB COMPUTERS LTD

22 NEWLAND STREET, KETTERING NORTHANTS.

Tel. (0536) 83922 & 520910 Telex 341297



ENSIGN

13-19 MILFORD STREET, SWINDON
WILTSHIRE SN1 1DW
Tel: (0793) 42615 • Telex: 449703

Make more time available to
enhance the quality of your
life and improve your business

COMPUTER SALES • HARDWARE • SOFTWARE • CONSULTANCY • MEDIA • STATIONERY ETC

For less than 25p an hour for just one year you can
COMPUTERISE YOUR BUSINESS NOW!
EVERYTHING YOU REQUIRE TO START
COMPLETE - READY TO OPERATE.
Incl. VAT, Pkg. & Delivery. Nothing extra to pay:

£3,000

- TRS 80 — PET — ITT 32K
- DUAL DISK DRIVES
- DOS DISKETTE
- DISKETTES WITH PROGRAMS
- PRINTER WITH TRACTOR FEED
- STATIONERY/LABELS/ENVELOPES
- EVERYTHING COMPLETE WITH MANUALS
- WORD PROCESSING PROGRAM
- TEACHING DISKETTE (ITT ONLY)

✚ A Selection of Programs on
Diskettes in a Library Case ✚

comprising (as available with up-dates):

SALES/PURCHASE LEDGERS QUOTE/ORDER/INVOICE
BANK RECONCILIATION STOCKS / SHARES ANALYSIS
STOCK CONTROL MAILING LIST GAMES PACKAGE

This package illustrates how to solve many of your business problems.
They may or may not be suitable for your type of application but they will
help you develop your own software for virtually any type of business.

PRINTERS

Anadex
Centronics
Paper Tiger
Teletype 43
Texas 810
Interface and cables

Prices
on
application

CONSULTANCY

Please write or telephone if you require advice on
BEGINNING or EXPANDING your computer installation.
Software programs customised to your requirements.

OUR BUSINESS EXISTS ON IMPROVING YOUR BUSINESS.

Please send Full Details & Price Lists

My requirements are for:

HOME HOBBIES STUDENT BUSINESS

Name :
Street :
Town :
County :
Post Code :
Telephone :
Name of Co :
Position :

PO/Chq No :

Cheque with order for clearance and delivery 7 days or cash/bankers draft
and carry away.

We are continually adding new products to our range and would be
pleased to receive your enquiries. ● Quantity Discounts available

TRS 80	ex. VAT	inc. VAT
4K Level 2 (c/w K/bd, VDU, T/Rec)	434.78	500.
16K Level 2 (c/w K/bd, VDU, T/Rec)	500.00	575.
0K Interface (to add printer & disk drives)	195.66	225.
16K Upgrade kits (for k/bd or interface)	65.22	75.
Disk Drives, single	260.88	300.
Disk Drives, dual	608.70	700.
Disk Drives, dual (up to 1000K)	1173.91	1350.
Disk Drives, dual (up to 2000K)	1521.74	1750.
Disk Drives, cable 2 & 4 way from	21.74	25.
Anadex Printer, Tractor feed	456.53	525.
Printer cable for Anadex/Centronics	21.74	25.

APPLE II ITT 2020

16K (c/w K/bd & Palsolt ROM)	695.65	800.
16K Upgrade kits	65.22	75.
Disk Drive, single with cable	326.09	375.
Printer Interface	108.70	125.
Anadex Printer, Tractor feed	456.53	525.
Colour TV ITT 340	239.13	275.

COMMODORE PET

2001-32N (New keyboard & 32K)	782.61	900.
2040 Dual Disk Drive 343K	782.61	900.
3022 Printer with graphics	608.70	700.
Printer cables, each	39.13	45.

MEDIA LIST

5 1/4" Verbatim	from (Qty 5)	10.43	12.
5 1/4" Verbatim	from (Qty 10)	17.39	20.
5 1/4" Dysan	from (Qty 10)	26.09	30.
8 1/2" 3M	from (Qty 10)	30.44	35.

Blank 5 1/4" & 8 1/2" Diskettes, Soft/Hard Sected, Formatted/Unformatted.
We have diskettes to suit many systems. When ordering please quote:
SYSTEM MANUFACTURER, MODEL, MEDIA TYPE, AND DISK SIZE
Available in smaller or larger quantities.

STATIONERY Listing Paper, Continuous Forms, Labels.

Listing paper 11" x 8 1/2", 11" x 9 1/2", 11" x 12", 8 1/2" x 12", boxed 2000, incl VAT £10
Labels 2 1/4" x 1 1/4", white, fanfold, £5 per 1000 12,000 incl VAT £40

Post/Packing/Insurance extra Delivery by Registered Post. Secunor, etc
Price List correct at time of going to Press, subject to change without notice. E & O E
Standard Warranties apply

Your enquiries assist us in forward purchasing.

Requirements	Description	inc VAT
Microcomputer
Upgrade Kit
Interface
Disk Drive
Printer
Cable/Interface
Cluster System
Colour TV
Media
Stationery
Software
Post/Pkg/Ins	(please tel for cost)
PC/PCWL	TOTAL

Packaged Information Processing Systems

We offer a variety of turnkey systems based on APPLE IICROMEMCCand ZENTEC. It is our endeavour to give a complete service from problem determination through to the supply of computer based solutions. We will solve the problem either with a tailor made suit of programs, or a ready written package from another famous software house.

We can also supply three excellent DEVELOPMENT SYSTEMS, namely NASCOM, ACORN and NORTH STAR HORIZON



Phone for further details or...

Come along and see all of the above equipment, plus a wide range of peripherals, which are now on display in our new offices and showroom.

AT
15 Sandhill, Keyside, Newcastle Upon Tyne
Tel: 0632 614939

P.I.P.S. Computer Services
(0632) 482359



BITS & P.C.s

COMPUTER PRODUCTS

NOW A NASCOM DISTRIBUTOR IN YORKSHIRE
FULL RANGE OF NASCOM PRODUCTS AVAILABLE
WE ARE NASCOM SERVICE AND REPAIR SPECIALISTS
ORDER WITH CONFIDENCE
FREE FOR A LIMITED PERIOD WITH NASCOM 2
16K MEMORY BOARD, MINI MOTHER BOARD AND
2 EDGE CONNECTORS THIS IS 8K MORE MEMORY
THAN SPECIFIED AND LEAVES 28K OF FREE SPACE
PRICE CUT! NASCOM 1 NOW ONLY £125 (KIT)
OR £140 BUILT

UPGRADE YOUR NASCOM 1 TO NASCOM 2

BY USING OUR SPECIAL
LY DESIGNED CONTROL
KEY PAD THIS ENABLES
YOU TO RUN NASCOM 2
ON NASCOM 1. GAIN ON
SCREEN, EDIT AND CUR
SOR MOVEMENT. THE
POWER OF NASCOM 2
ONLY £2150 NASCOM 2

NASCOM 1 £165.00

NASCOM 2 £295.00

POWER SUPPLY UNIT £29.50

NASCOM BUFFER BOARD £32.50

8K RAM BOARD £85.00

16K RAM BOARD £140.00

32K RAM BOARD £200.00

NASCOM 1 GRAPHICS £115.00

NASCOM 2 GRAPHICS ROOM £15.00

BITS & P.C.s DATA CASSETTES PRICE FOR 10/12 £4.75

PLEASE CHECK WITH US FOR YOUR NASCOM REQUIREMENTS

ADD 45% VAT TO ALL OUR PRICES

BARCLAY CARD AND ACCESS PHONE YOUR ORDER

PERSONAL DEMONSTRATIONS BY APPOINTMENT

PLEASE SEND S.A.E. FOR ANY DETAILS

BITS & P.C.s 18 RYE GARTH WETHERBY WEST YORKSHIRE LS17 4UL TELEPHONE (0937) 63744 9a.m. to 5p.m.

A HEXADECIMAL KEY CODE LISTINGS NEW LINE, SPACE AND BACKSPACE ARE DUPLICATED FOR YOUR NASCOM BY FOR CONVENIENCE
THIS IS AN ESSENTIAL £29.50 COMPLETE KIT FOR ENTRY OF MACHINE

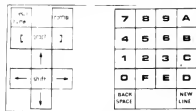

CONTROL AND HEXADECIMAL KEY PADS COMBINED FOR NASCOM 1
£165.00 COMPLETE KIT. THE ABOVE KEY PADS REQUIRE NO MODIFICATION AT ALL TO YOUR NASCOM

PORT PROBE
A SIMPLE BUT ESSENTIAL DEVICE FOR NASCOM 1 OR 2. ALLOWS MONITORING OF THE PORT OUTPUT ON LED INDICATORS. INPUT WORDS CAN BE SET UP WITH LED INDICATION. INTERRUPTS CAN BE TESTED MANUALLY OR BY USING THE VARIABLE CLOCK. PROVIDED THIS ALSO ALLOWS REAL TIMING FOR GAMES. £10.00 COMPLETE KIT

DUAL MONITOR BOARD
THIS KIT ALLOWS SWITCHING BETWEEN 2 MONITORS ON NASCOM 1 £5.40

CHESS FOR NASCOM
A POWERFUL CHESS PROGRAMME WHICH REQUIRES OUR GRAPHICS OPTIONS. THIS MUST BE THE BEST CHESS GRAPHICS AVAILABLE. £15.00 ON CASSETTE. ASK FOR DETAILS

COMPUTERS FOR HOME BUSINESS EDUCATION

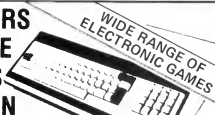

Erudy Sorcerer
8K - £477.50 16K - £974.00 32K - £987.75
\$100 Expansion Box 6-slot - £241.50
Micropolis Dual Disc Drive - £1,380.00
Centronics 779 Printer - £920.00



PET 2001 House Trained

PET 2001 4K - £520.00
8K - £832.00
16K - £776.00
DUAL DISC DRIVE £861.00

APPLE II (b&w) 16K RAM £954.50. Disc drive & controller £488.75

5 1/2 in. disks £4.90 ea. 8 in. disks £5.90 ea.

Plastic Print Wheels IBM etc. £5.95 £201.25

NASCOM 1 kit £143.75 or Built & Tested £396.75

NASCOM 2 kit £339.25 or Built and Tested £396.75

Ohio SUPERBOARD II 8K Basic, 4K RAM Built & Tested £216.20

COMPUKIT UK101 8K Basic, 4K RAM+Power Supply Built & Tested £216.20

KIT £251.85

TRS 80 Level II 16K RAM, computer only £460.00

16K Memory expansion kits (APPLE - SORCERER - TRS 80) only £79.35

3A Power Supply kit £28.90 Built & Tested £33.90

TRS 80 Library 100-100 Programs on Cassettes £43.95

2K BASIC for NASCOM 1 used in place of Nasbug or B-Bug £22.90

Large range of computer etc. books. Send for List

S.A.E. with all enquiries - All prices inclusive.

SUPPLIERS TO BUSINESS, EDUCATION & HEALTH AUTHORITIES

N.I.C
61 Broad Lane, Tottenham, London N15.
01-808 0377



NewBear Books



WE HAVE 397 TITLES IN STOCK, SEND FOR COMPLETE LIST.

GAMES

Chess & Computer	D. Levy	£ 7.16
Chess Skill in Man and Machine	P. Frey	£11.84
32 Basic Programs for the Pet	£ 9.95
Game Playing with Computers	D. Spencer	£10.20
Basic Computer Games	D. Ahl	£ 5.50
Star Ship Simulation	£ 5.10
Game Playing with Basic	D. Spencer	£ 4.10
Sargon	Spracklen	£ 9.50

MISCELLANEOUS

Intro. to TRS 80 Graphics	£ 5.75
Microprocessors C201	Zaks	£ 7.50
Scelbi Byte Primer	£ 9.95
Business Data Systems	Clinton	£ 5.75
The Systems Analyst	Atwood	£ 6.60
Your Home Computer	White	£ 4.95
Programming a Micro 6502	Foster	£ 7.95
6502 Applications Handbook	Zaks	£ 8.95

BASIC

Learning Basic Fast	De Rossi	£ 6.30
Basic Basic	J. S. Coan	£ 5.00
Advanced Basic	J. S. Coan	£ 5.50
Illustrated Basic	D. Alcock	£ 2.25
Basic with Business Applications	Hayden	£ 8.40
Introduction to Basic	J. Morton	£ 6.50
The Basic Handbook	Lien	£11.00

COBOL

Cobol Programming	Nickerson	£ 6.95
Learning Cobol Fast	De Rossi	£ 6.20
Cobol with Style	Hayden	£ 4.20
Reducing Cobol Complexity	Mc Clue	£11.30

PASCAL

Pascal: User Manual and Report	Springer-Verlag	£ 5.52
Problem Solving Using Pascal	Springer-Verlag	£ 7.84
Programming in Pascal	P. Grogono	£ 7.50
A Practical Intro. to Pascal	A. Aldyman	£ 3.50
An Introduction to Programming and
Problem Solving with Pascal	Schneider	£ 9.50
Introduction to Pascal	J. Welsh & J. Elder	£ 6.95

FORTRAN

Elementary Computer
Programming in Fortran IV	Boguslausky	£ 6.30

PROGRAMMING

Chemistry with a Computer	P. A. Cauchon	£ 7.96
Seminumerical Algorithms	Knuth	£17.85
Fundamental Algorithms	Knuth	£17.85
Assembly Level Programming for
Small Computers	W. J. Weller	£12.50
Sorting & Searching	Knuth	£17.85
Top-Down Structured
Programming Techniques	McGowan	£12.50
The Design of Well Structured
and Correct Programs	Alagic & Arbib	£10.00
Computer Mathematics	£ 8.58
Basic Principles of Data Processing	Saxon/Steiner	£ 7.75
Fundamentals of Computer
Algorithms	Horowitz/Sahni	£15.00
Computer Approach to Introductory
College Mathematics	Scalzo	£11.30
Computer Input Design	Woolridge	£ 8.85
Computer Output Design	Woolridge	£ 9.70
How to Program Micro's	Barden	£ 6.55
CREDIT SALES (Minimum £10), Access and Barclaycard
Welcome. "BY RETURN ORDER SERVICE"

CALLERS AND MAIL ORDER: 40 Bartholomew Street, Newbury, Berks. Tel: 0635 30505
 CALLERS ONLY: 220-222 Stockport Road, Cheadle Heath, Stockport Tel: 061 491 2290



Digital Design & Development



43 Grafton Way, London W1P 5LA
 Tel: 01-387-7388

PRINTER INTERFACES FOR THE NEW SHARP MZ-80K MICROCOMPUTER

* PARALLEL PRINTER INTERFACE (PPI)

Will allow you to connect your MZ-80K to most parallel printers such as the Centronics 700 series, including the 730, Anadex DP8000, etc. Supplied boxed complete with integral power supply, ribbon cables, and connectors for the Sharp MZ-80K and the printer.

* PRICE £110 + VAT EX-STOCK

* SERIAL PRINTER INTERFACE (SPI)

This interface provides both RS232C and 20 mA current loop outputs to drive such printers as Teletypes, Silent 700s, Qume, Centronics, VDUs, etc. Switch-selectable baud rate (50-19,200), no. of stop/character bits, parity, etc.

* PRICE £150 + VAT EX-STOCK

* BIDIRECTIONAL SERIAL INTERFACE (BSI)

Allows the MZ-80K to communicate with most serial devices, such as printers, VDUs, Teletypes, intelligent terminals, other computers, modems, etc. Connect your Sharp MZ-80K to a mainframe with this interface.

* PRICE £210 + VAT EX-STOCK

All the above interfaces are boxed units complete with software, power supply, cables and connectors for the MZ-80K and printer.

Quantity Discounts on Application.
 Dealer Inquiries Welcomed.

Tridata + MICROS = SOFTWARE

Business systems available now for the TRS 80

Sales Ledger (OPEN ITEM/DEBTORS ANALYSIS/STATEMENTS/INVOICES/VAT/DAYBOOKS etc.) £ 225

Purchase Ledger (OPEN ITEM/CREDITORS ANALYSIS/REMITTANCE ADVICE/VAT/DAYBOOK etc.) £ 225

Invoicing (UPDATES SALES LEDGER/DOWNDATES STOCK/MAINTAINS BACK ORDERS) £ 75

Stock Control (ISSUES/RECEIPTS/MOVEMENT, USAGE, VALUATION, RE-ORDER REPORTS etc.) £ 200

Payroll (WEEKLY, MONTHLY, CASUAL STAFF/BONUS SCHEMES/COIN ANALYSIS/PAYSLIPS etc.) £ 218

Nominal Ledger from £225

12 MONTH WARRANTY ON ALL PACKAGES - TAILORED SYSTEMS TO YOUR REQUIREMENTS

FOR THE BEST IN PROFESSIONAL MICRO BUSINESS SOFTWARE CONTACT US DIRECT OR CALL YOUR NEAREST TRIDATA DEALER FOR A DEMONSTRATION.

CAMBRIDGE COMPUTER STORE (CAMBRIDGE)	0223 68155
COMPUTER DEVELOPMENT SERVICES (SWANSEA)	0792 26085
ELECTRON SYSTEMS (SANDY, BEDS.)	0767 81195
A. J. HARDING (BEKHILL, E. SUSSEX)	0424 220391
KATANNA MANAGEMENT SERVICES (CHELMSFORD)	0245 76127
OPTRONICS (TWICKENHAM)	01 892 8455
GPW ELECTRONICS LTD (PORTSMOUTH)	0705 693341



Tridata Micros Ltd.
Smithfield House
Digbeth
Birmingham B5 6BS
Tel: 021 622 6085/6

Southwark Computer Services Limited

OFFER

**MICRO BASED HARDWARE SUPPORTING MINI-COMPUTER SOFTWARE
BASED ON A MOTOROLA 6089**

**PACKAGES INCLUDE GENERAL LEDGER
PURCHASE LEDGER
SALES LEDGER
PAYROLL**

**COMPLETE SYSTEMS START FROM £10,500
FOR MORE INFORMATION CONTACT BRIAN CANNON
95 SOUTHWARK STREET, LONDON SE1 0JA**

TELEPHONE 01-928 0444

OSI for less than you expect

£220
+ VAT



OSI equipment offers the largest range of expandable computers today. Supported by an increasing number of application packages, OSI hardware gives capabilities that other machines cannot match.

We support OSI totally with a commitment to offer very competitive prices, a good technical back-up policy and rapid deliveries where possible.

But that's not all.

Mutek pursues an active policy of bringing new OSI compatible products to the marketplace and developing hardware and software for your applications.

So if you're thinking of OSI think of Mutek.

Computers for less than you expect.

MUTEK

Quarry Hill, Box, Wilts. (0225) 743289

The Challenger 1P (Superboard in a case) at £220 +VAT impossible to beat.

Software for Superboard, C1 and C2

The largest range of software for OSI available today including many games and a wide variety of utility packages such as the new

SIRIUS CYBERNETICS Editor Package

Gives your C1 or C2 the capabilities of a machine costing 1.637 times the price, with full content line editing, insertion, concatenation, true backspacing and much more. Only £7.50. C2 version available now; C1 version available shortly.

Extra memory special this month: 2114s at £3.00.

We usually have the entire OSI range in stock, together with Intertec Intertube terminals, printers and many other lines. Call us for a quote.

All prices quoted are excluding VAT.

COMPLETE COMPUTER SYSTEMS (CCS)

PRESENT
the **ABC80**

Zilog Z80A microprocessor, the ABC 80's brain.

Professional keyboard of Swedish standard

12" black-and-white TV screen

Displays capitals and small letters, digits, figures and diagrams. Room for 24 lines of 40 characters each

Built-in graphic mode Uses 64 different graphic symbols
Program memory 16 K BASIC of ROM, 16K bytes of RAM 2K Monitor in ROM 1K Picture RAM
Loudspeaker 128 different sound effects Can be used to provide alarms or other signals

Cassette memory for storing programs and data. Fast winding in both directions.



Built-in real-time clock for timing
price £790.00 (optionally). Available from U.K. Importers

V-24 jack for connecting to a telephone modem so that you can communicate with other computer systems via the public telephone network

46-90 Bus for connecting peripherals such as floppy-disk units, printers, plotters, measuring instruments etc.

CCS MICROSALES
22 WESTSIDE
68 FORTIS GREEN
LONDON N2 9EN
Tel: Letchworth
(04626) 73301

The Leading Microcomputer Hire Company with the best range of equipment:

ABC 80, PET (8K) now £4.20/day*

APPLE (16K) now £5.70/day*
Apple II; PET; Exidy Sorcerer;
SEED System One/MSI 6800;
NASCOM/MICROS; Research
Machines 380Z and Tandy
TRS-80

Over 500 million Bytes (half megabytes memory) available for hire in units from 4K to 48K.

Send for our NEW PRICE LIST giving the most attractive prices yet.

* four day rates
CCS MICROHIRE
7 The Arcade
LETCWORTH
Herts SG2 4YA

I would like to come and see the ABC80, PET, APPLE
Please call me back to arrange an appointment.
NAME.....
Company.....
Location.....
Tel.....Ext.....

MICRO-COMPUTERS ARE

NO FURTHER

BUSS STOP

THAN THE...



Petsoft
Send for Catalogue
commodore

New BK PET with large keyboard £480.00
16K RAM and New Large Keyboard £632.00
32K RAM and New Large Keyboard £745.00
PET 3040 Dual Mini-Floppy 340K £745.00
PET 3022 80 col. dot matrix printer with tractor feed £604.00
PET C2N External Cassette Deck £ 51.00
KIM1 Micro system £ 93.00
KIM3B Memory Expansion £121.00
KIM4 Motherboard £ 65.00
Phone for Cash 'n' Carry prices and educational discount

NASCOM
Nascom-1 A KIT £125.00
Nascom 1A BUILT £140.00
Nascom 2 KIT £295.00
Nascom 1MP printer £325.00

SOFTWARE ONLY £ 4.50
C12's Boxes of 10
Floppy Disks boxes of 10
COMMODORE BUSINESS SOFTWARE, £ 35.00
PETSOFT & PETACTION - our software team can modify these to your requirements. Books - large range available.

REPAIRS - all done in our own workshop. Service contracts are available. Hire PET 32K - £65.00 per day.
Carriage - £12 on hardware other items £1. All prices + VAT

For more details & demonstrations Call or ring Mr. Eva at BUSSTOP, 255a St. Albans Rd., Watford, Herts. (entrance in Judge Street)
Phone: Watford 40699 or Newport Pagnell 610625

MAIL ORDER:
The Studio,
Perry Lane,
Sherington,
Newport Pagnell, Bucks
Phone: (0906) 610625

MINE OF INFORMATION LTD

SELECTED MICROCOMPUTER BOOKS

1 Francis Avenue, St Albans, AL3 6BL England
Phone 0727 52801 Telex 925859

- 6 90 LEVENTHAL Lance 6 90
103 33088 27 4
- 6 90 ZAKS Rodney 6 90
1978 202pp £ 25.00
0 35068 059 1
- 7 00 BUTTERFIELD et al 7 00
1978 176pp £ 20.00
0 304 5119 0
- 7 00 ZAKS Rodney 7 00
1979 264pp £ 32.00
0 35068 015 8
- 7 00 FOSTER Caxton C 7 00
1978 234pp £ 28.00
0 201 3195 7
- 7 00 WILSON AODYMAN 7 00
1978 222pp £ 27.00
0 333 23482 7
- 7 00 COLEMAN Derek 7 00
1978 222pp £ 27.00
0 333 21943 0
- 7 00 HARTMANN A C 7 00
1977 170pp £ 20.00
0 387 08240 9
- 7 00 JENSEN WIRTH 7 00
1978 167pp £ 20.00
0 387 90144 2
- 7 00 SCHNEIDER et al 7 00
1978 410pp £ 47.00
0 471 04431 6
- 7 00 WELSH ELDER 7 00
1978 300pp £ 35.00
0 13 491522 4
- 7 00 GREGGON Peter 7 00
1978 369pp £ 43.00
0 201 02473 5
- 7 00 BOWLES Kenneth 7 00
1977 563pp £ 67.00
0 387 82886 4
- 8 00 KIEBURTZ Richard 8 00
1978 365pp £ 43.00
0 13 48489 2
- 13 00 WIRTH Niklaus 13 00
1976 369pp £ 43.00
0 13 922418 5
- 15 40 BRINCH-HANSEN Per 15 40
1977 328pp £ 39.00
0 13 044628 9

Circle the price of each title chosen and indicate quantity required
Total value of books chosen + 10% for delivery outside the UK
Prices are subject to change without notice, due to external factors

The Rohan Computing Collection.....

Qume
CIPER
digital
OKI

Sprint 5/45 Daisywheel printer/terminal, ideal for word processing and general use, RS 232 standard, successfully installed on PET's, Apples, Tandy TRS 80, Sorcerer etc...
Wordstar The best word processor for cpm systems. Special version with addressing facility.
Wordcraft Converts a 32k PET & discs into a superb word-processor.

VDU's The most legible VDU's on the market, superbly made and British. All black or seafoam finish. Detachable 62 or 102 key keyboards. Lear Seiger and VT52 emulation. FROM £600.00
2684 Microcomputer as VDU's but 2nd Z80, integral disc and CPM, graphics facility.

LA 34 The best desk top , full width, 30cps terminal, 10, 12, 16 characters per inch, optional tractor.
LS 120 180 cps terminal.
11/03 & 11/23 computer systems available with CAP MicroCOBOL, accounts, Autoclerk,

Microline 80 The smallest and quietest desk top printer available (61db) 5,10 or 16 characters per inch, 40,30, 132 wide. Standard machine will take 9.5 inch sprocket feed paper, roll and single sheet. With centronics interface, PET IEEE or user port interface, Tandy TRS 80 directly to keyboard unit without expansion box. FROM £499.00.

TNW 2000 The only bi-directional PET to RS 232 interface we know that runs Qumes etc. at full speed i.e. 1200 baud £165.00. Also available Teletype 43, North Star, Rair Black Box.

TRADE & EDUCATIONAL ENQUIRIES WELCOME,

Rohan Computing 52 Coventry St., Southam, Warwickshire CV33 0EP. Tel: Southam (092681) 4045

OPTRONICS

INFINITE BASIC

If you already own a TRS-80 with disk system or are thinking of purchasing a micro... we now offer the most advanced BASIC ever implemented on a micro. The TRS-80 Disk Basic is already very powerful... infinite basic adds to this over 70 major commands! Also we will be offering in the future *Infinite Business, Infinite Statistics, Infinite Input/Output and Infinite Graphics*... all from the well known Californian software house *Racet Computers*, so we can promise they will be good. We already handle their complete range of software.

We are now handling the book "TRS 80 DISK And Other Mysteries". If you are running a DISK system, or are about to purchase, this book is a must. For the first time ever the DOS system is fully explained, together with methods for correcting DOS errors, modifications to the ELECTRIC PENCIL. TOTAL PRICE INCLUDING VAT & P&P £16.00

BUSINESS SYSTEM SOFTWARE

We are agents for the superb range offered by *Tridata* which is written in the UK by professionals who know what they are doing...!

OPTRONICS, 50 HOLLY ROAD
TWICKENHAM, MIDDLESEX

TEL: 01-892 8455 - Visitors by appointment

hi-tech electronics

1 Richmond Gardens, Highfield Southampton SO2 1RY
Telephone (0703)585072

OUR S100 COLOUR VDU BOARD

WILL MAKE YOUR FRIENDS GREEN WITH ENVY AND OUR COMPETITORS SEE RED AND ANY OTHER OF OUR SLENDID RANGE OF COLOURS

- HIGH DEFINITION, FULLY INTERLACED 625 LINE PAL COLOUR VDU BOARD
- 20 COLOURS AND GREY SCALE TONES, INCLUDING RED, GREEN, BLUE, YELLOW, MAGENTA, CYAN, BROWN, PURPLE, ETC.
- 24 LINES OF 40 CHARACTERS, MIXED GRAPHIC AND ALPHANUMERIC
- COLOUR GRAPHICS RESOLUTION OF 80 X 72
- UPPER AND LOWER CASE, DEFINITION OF 10:14
- ALL CHARACTERS CAN FLASH AND HAVE ANY HUE
- SEPARATE BACKGROUND AND FOREGROUND COLOURS
- 236 DIFFERENT GRAPHIC CHARACTERS
- SELECTABLE DOUBLE-HEIGHT CHARACTERS AND TWO PAGE MEMORY
- 1K MEMORY, MAPPED TO ANY 2K BOUNDARY
- 64 PORT - PROGRAMMABLE INSTRUCTIONS
- MONITOR, OR UHF OUTPUT, RGB TO ORDER
- TELETEXT AND PRESTEL COMPATIBLE CHARACTER SET
- BRITISH DESIGNED AND MADE

NOW AVAILABLE

- PROGRAMMABLE 13A MAINS DISTRIBUTION BOX, FULLY ISOLATED, FITS TTL 8 BIT LATCHED PARALLEL OUTPUT PORT FROM YOUR COMPUTER, AND CONTROLS 3 ON/OFF AND 1 22-VOLT DIMMER SOCKETS £89.00
 - S100 COLOUR VDU BOARD, UHF OUTPUT £295.05
 - S100 COLOUR VDU BOARD, MONITOR OUTPUT £295.05
 - S100 16K MEMORY BOARD, 250 nS £210.95
- PRICES INCLUDE P&P - BUT NOT 15% VAT

COMING SOON:

- S100 TELETEXT TUNER/DECOODER, S100 MUSIC SYNTHESISER, ETC

MICRODIGITAL BOOKS

BEST SELECTION-BEST PRICES-BEST SERVICE
25 Brunswick Street, Liverpool 2. Tel 051-226 077 (Mail Order)
051-227 2535 (All Other Depots)

Accounts Payable & Receivable £19.95	Basic - A user for Secondary Schools £4.45	8080 Programmer Pocket guide £1.95	Home Computers: A Beginners Glossary and Guide £4.95	Micro/Computer Interface with the £10.00
Active Filter Cookbook £9.95	Basic Programming £6.95	8080A Bugbook £7.65	Hobby Computers Are Here £3.95	Micro/micro (TM) £12.95
Adaptor Jigs, Processing £8.75	Basic Printer £11.00	8080 Programming for Logic Design £5.95	Increase Secret Money Machine £4.75	Microprocessor Basics £7.00
Advanced Basic £4.00	Collection of Programming Problems and Techniques £12.00	8080/8085 Assembler Language £6.95	Intro to Artificial Intelligence £14.80	Micro - New Direction for Designers £7.60
Algorithms & Data Structure Equals Program £14.00	Computer Data Directory £3.98	8080/8085 Software Design £7.65	Intro to Computer Prog £4.75	Microprocessors Data Manual £5.00
Analysis of a Compiler £15.00	Computer Lab/Organic machines £17.95	8080 Machine Language Programming for Beginners £5.10	INTRODUCTION TO MICROCOMPUTERS, Vol 0 £5.95 Vol 1 £11.95 Vol 2 £11.95	Micros for Business Applications £17.15
Art - An Interactive Approach £9.50	Computer Models of Thought and Language £5.95	8080 Microcomputer Experiments £10.25	Intro to Computer Prog £4.75	Micro Basic Computer games £1.50
Artificial Intelligence £16.40	Computer Power and Human reasons £4.76	8080 Standard Monitor £19.95	Introduction to Basic £7.15	Microprocessor Potpourri £5.75
Art & Computer £3.96	Computer resources book Algebra £4.00	8080 Standard Editor £9.95	Interfacing and Communications £4.95	Modern Operational Circuit Design £3.60
Art Computer Programming £8.50 S/B Vol. 1 £16.45 H/B	Computer Science a First Course £15.00	8080 Standard Assembler £9.95	Intro to Comp. Prog. Solving with Pascal £9.95	Microgrammed APL Implementation £4.75
Art Computer Programming £16.45	Computer Science Programming in Fortran IV £7.80	8080 Standard Assembler £9.95	Instant Basic £8.50	Micro Memory Data Book £2.80
Art Computer Programming £12.76	Computer Science Projects and Study problems £8.75	8080 Standard Assembler £9.95	Introduction to Basic £7.15	Microprocessor Encyclopedia Vol 2 £7.45
Art Computer Programming £16.45	Concurrent Basic Compiler £6.40	8080 Standard Assembler £9.95	Interfacing and Communications £4.95	9900 Family systems Design & Data Book £7.95
Assembly Level Programming for small computers £12.76	Concurrent Basic Compiler £6.40	8080 Standard Assembler £9.95	Introductory Experiments in Digital Electronics Vol 1 £8.75	1975 U.S. Comp Chess £4.75
Analysis and design of Digital Circuits and Computer Systems £16.40	Concurrent Basic Compiler £6.40	8080 Standard Assembler £9.95	Electronics Vol 2 £7.75	1976 U.S. Comp Chess £4.75
API Implementation £12.76	Concurrent Basic Compiler £6.40	8080 Standard Assembler £9.95	Introduction to TRS - 80 £7.75	1977 U.S. Comp Chess £4.75
Accent on Basic £4.95	Concurrent Basic Compiler £6.40	8080 Standard Assembler £9.95	Graphics £5.25	1978 U.S. Comp Chess £4.75
About Computers £6.95	Concurrent Basic Compiler £6.40	8080 Standard Assembler £9.95	Hardware Notes £6.95	1979 U.S. Comp Chess £4.75
Active Filters £6.45	Concurrent Basic Compiler £6.40	8080 Standard Assembler £9.95	Illustrating Basic £2.25	1980 U.S. Comp Chess £4.75
Analogue/Digital Experiments £17.15	Concurrent Basic Compiler £6.40	8080 Standard Assembler £9.95	IC O'Clock Cookbook £8.95	1981 U.S. Comp Chess £4.75
A guided tour of Computer Programming in Basic £4.16	Concurrent Basic Compiler £6.40	8080 Standard Assembler £9.95	IC O'Clock Cookbook £8.95	1982 U.S. Comp Chess £4.75
A quick look at Basic £4.45	Concurrent Basic Compiler £6.40	8080 Standard Assembler £9.95	IC O'Clock Cookbook £8.95	1983 U.S. Comp Chess £4.75
Apple II Operators Manual £5.50	Concurrent Basic Compiler £6.40	8080 Standard Assembler £9.95	IC O'Clock Cookbook £8.95	1984 U.S. Comp Chess £4.75
Apple II Integer Basic manual £3.55	Concurrent Basic Compiler £6.40	8080 Standard Assembler £9.95	IC O'Clock Cookbook £8.95	1985 U.S. Comp Chess £4.75
Apple II Appendix Extended Basic Manual £5.75	Concurrent Basic Compiler £6.40	8080 Standard Assembler £9.95	IC O'Clock Cookbook £8.95	1986 U.S. Comp Chess £4.75
Advanced Business, Billing, Inventory, Investments, Payroll £26.95	Concurrent Basic Compiler £6.40	8080 Standard Assembler £9.95	IC O'Clock Cookbook £8.95	1987 U.S. Comp Chess £4.75
An Introduction to Your New Pet. £11.80	Concurrent Basic Compiler £6.40	8080 Standard Assembler £9.95	IC O'Clock Cookbook £8.95	1988 U.S. Comp Chess £4.75
Basic £5.60	Concurrent Basic Compiler £6.40	8080 Standard Assembler £9.95	IC O'Clock Cookbook £8.95	1989 U.S. Comp Chess £4.75
Basic A Hands on Method £6.50	Concurrent Basic Compiler £6.40	8080 Standard Assembler £9.95	IC O'Clock Cookbook £8.95	1990 U.S. Comp Chess £4.75
Basic and the Personal Computer £10.80	Concurrent Basic Compiler £6.40	8080 Standard Assembler £9.95	IC O'Clock Cookbook £8.95	1991 U.S. Comp Chess £4.75
Basic, Basic £4.80	Concurrent Basic Compiler £6.40	8080 Standard Assembler £9.95	IC O'Clock Cookbook £8.95	1992 U.S. Comp Chess £4.75
Basic Computer Games Micro £5.50	Concurrent Basic Compiler £6.40	8080 Standard Assembler £9.95	IC O'Clock Cookbook £8.95	1993 U.S. Comp Chess £4.75
Basic with the Ground-Up £7.90	Concurrent Basic Compiler £6.40	8080 Standard Assembler £9.95	IC O'Clock Cookbook £8.95	1994 U.S. Comp Chess £4.75
Basic Microprocessors and the 8080 £7.20	Concurrent Basic Compiler £6.40	8080 Standard Assembler £9.95	IC O'Clock Cookbook £8.95	1995 U.S. Comp Chess £4.75
Basic with Business Application £8.40	Concurrent Basic Compiler £6.40	8080 Standard Assembler £9.95	IC O'Clock Cookbook £8.95	1996 U.S. Comp Chess £4.75
Basic with Style/Programming proverbs £3.60	Concurrent Basic Compiler £6.40	8080 Standard Assembler £9.95	IC O'Clock Cookbook £8.95	1997 U.S. Comp Chess £4.75
Basic Workbook £3.79	Concurrent Basic Compiler £6.40	8080 Standard Assembler £9.95	IC O'Clock Cookbook £8.95	1998 U.S. Comp Chess £4.75
Best of Creative Computing Vol 1 £6.95	Concurrent Basic Compiler £6.40	8080 Standard Assembler £9.95	IC O'Clock Cookbook £8.95	1999 U.S. Comp Chess £4.75
Best of Creative Computing Vol 2 £6.95	Concurrent Basic Compiler £6.40	8080 Standard Assembler £9.95	IC O'Clock Cookbook £8.95	2000 U.S. Comp Chess £4.75
Byte Book of Computer Music £7.90	Concurrent Basic Compiler £6.40	8080 Standard Assembler £9.95	IC O'Clock Cookbook £8.95	2001 U.S. Comp Chess £4.75
Beginners Glossary and Guide £5.75	Concurrent Basic Compiler £6.40	8080 Standard Assembler £9.95	IC O'Clock Cookbook £8.95	2002 U.S. Comp Chess £4.75
Beginners Basic £7.50	Concurrent Basic Compiler £6.40	8080 Standard Assembler £9.95	IC O'Clock Cookbook £8.95	2003 U.S. Comp Chess £4.75
Byte Vol 1 £8.45	Concurrent Basic Compiler £6.40	8080 Standard Assembler £9.95	IC O'Clock Cookbook £8.95	2004 U.S. Comp Chess £4.75
	Concurrent Basic Compiler £6.40	8080 Standard Assembler £9.95	IC O'Clock Cookbook £8.95	2005 U.S. Comp Chess £4.75
	Concurrent Basic Compiler £6.40	8080 Standard Assembler £9.95	IC O'Clock Cookbook £8.95	2006 U.S. Comp Chess £4.75
	Concurrent Basic Compiler £6.40	8080 Standard Assembler £9.95	IC O'Clock Cookbook £8.95	2007 U.S. Comp Chess £4.75
	Concurrent Basic Compiler £6.40	8080 Standard Assembler £9.95	IC O'Clock Cookbook £8.95	2008 U.S. Comp Chess £4.75
	Concurrent Basic Compiler £6.40	8080 Standard Assembler £9.95	IC O'Clock Cookbook £8.95	2009 U.S. Comp Chess £4.75
	Concurrent Basic Compiler £6.40	8080 Standard Assembler £9.95	IC O'Clock Cookbook £8.95	2010 U.S. Comp Chess £4.75
	Concurrent Basic Compiler £6.40	8080 Standard Assembler £9.95	IC O'Clock Cookbook £8.95	2011 U.S. Comp Chess £4.75
	Concurrent Basic Compiler £6.40	8080 Standard Assembler £9.95	IC O'Clock Cookbook £8.95	2012 U.S. Comp Chess £4.75
	Concurrent Basic Compiler £6.40	8080 Standard Assembler £9.95	IC O'Clock Cookbook £8.95	2013 U.S. Comp Chess £4.75
	Concurrent Basic Compiler £6.40	8080 Standard Assembler £9.95	IC O'Clock Cookbook £8.95	2014 U.S. Comp Chess £4.75
	Concurrent Basic Compiler £6.40	8080 Standard Assembler £9.95	IC O'Clock Cookbook £8.95	2015 U.S. Comp Chess £4.75
	Concurrent Basic Compiler £6.40	8080 Standard Assembler £9.95	IC O'Clock Cookbook £8.95	2016 U.S. Comp Chess £4.75
	Concurrent Basic Compiler £6.40	8080 Standard Assembler £9.95	IC O'Clock Cookbook £8.95	2017 U.S. Comp Chess £4.75
	Concurrent Basic Compiler £6.40	8080 Standard Assembler £9.95	IC O'Clock Cookbook £8.95	2018 U.S. Comp Chess £4.75
	Concurrent Basic Compiler £6.40	8080 Standard Assembler £9.95	IC O'Clock Cookbook £8.95	2019 U.S. Comp Chess £4.75
	Concurrent Basic Compiler £6.40	8080 Standard Assembler £9.95	IC O'Clock Cookbook £8.95	2020 U.S. Comp Chess £4.75
	Concurrent Basic Compiler £6.40	8080 Standard Assembler £9.95	IC O'Clock Cookbook £8.95	2021 U.S. Comp Chess £4.75
	Concurrent Basic Compiler £6.40	8080 Standard Assembler £9.95	IC O'Clock Cookbook £8.95	2022 U.S. Comp Chess £4.75
	Concurrent Basic Compiler £6.40	8080 Standard Assembler £9.95	IC O'Clock Cookbook £8.95	2023 U.S. Comp Chess £4.75
	Concurrent Basic Compiler £6.40	8080 Standard Assembler £9.95	IC O'Clock Cookbook £8.95	2024 U.S. Comp Chess £4.75
	Concurrent Basic Compiler £6.40	8080 Standard Assembler £9.95	IC O'Clock Cookbook £8.95	2025 U.S. Comp Chess £4.75
	Concurrent Basic Compiler £6.40	8080 Standard Assembler £9.95	IC O'Clock Cookbook £8.95	2026 U.S. Comp Chess £4.75
	Concurrent Basic Compiler £6.40	8080 Standard Assembler £9.95	IC O'Clock Cookbook £8.95	2027 U.S. Comp Chess £4.75
	Concurrent Basic Compiler £6.40	8080 Standard Assembler £9.95	IC O'Clock Cookbook £8.95	2028 U.S. Comp Chess £4.75
	Concurrent Basic Compiler £6.40	8080 Standard Assembler £9.95	IC O'Clock Cookbook £8.95	2029 U.S. Comp Chess £4.75
	Concurrent Basic Compiler £6.40	8080 Standard Assembler £9.95	IC O'Clock Cookbook £8.95	2030 U.S. Comp Chess £4.75
	Concurrent Basic Compiler £6.40	8080 Standard Assembler £9.95	IC O'Clock Cookbook £8.95	2031 U.S. Comp Chess £4.75
	Concurrent Basic Compiler £6.40	8080 Standard Assembler £9.95	IC O'Clock Cookbook £8.95	2032 U.S. Comp Chess £4.75
	Concurrent Basic Compiler £6.40	8080 Standard Assembler £9.95	IC O'Clock Cookbook £8.95	2033 U.S. Comp Chess £4.75
	Concurrent Basic Compiler £6.40	8080 Standard Assembler £9.95	IC O'Clock Cookbook £8.95	2034 U.S. Comp Chess £4.75
	Concurrent Basic Compiler £6.40	8080 Standard Assembler £9.95	IC O'Clock Cookbook £8.95	2035 U.S. Comp Chess £4.75
	Concurrent Basic Compiler £6.40	8080 Standard Assembler £9.95	IC O'Clock Cookbook £8.95	2036 U.S. Comp Chess £4.75
	Concurrent Basic Compiler £6.40	8080 Standard Assembler £9.95	IC O'Clock Cookbook £8.95	2037 U.S. Comp Chess £4.75
	Concurrent Basic Compiler £6.40	8080 Standard Assembler £9.95	IC O'Clock Cookbook £8.95	2038 U.S. Comp Chess £4.75
	Concurrent Basic Compiler £6.40	8080 Standard Assembler £9.95	IC O'Clock Cookbook £8.95	2039 U.S. Comp Chess £4.75
	Concurrent Basic Compiler £6.40	8080 Standard Assembler £9.95	IC O'Clock Cookbook £8.95	2040 U.S. Comp Chess £4.75
	Concurrent Basic Compiler £6.40	8080 Standard Assembler £9.95	IC O'Clock Cookbook £8.95	2041 U.S. Comp Chess £4.75
	Concurrent Basic Compiler £6.40	8080 Standard Assembler £9.95	IC O'Clock Cookbook £8.95	2042 U.S. Comp Chess £4.75
	Concurrent Basic Compiler £6.40	8080 Standard Assembler £9.95	IC O'Clock Cookbook £8.95	2043 U.S. Comp Chess £4.75
	Concurrent Basic Compiler £6.40	8080 Standard Assembler £9.95	IC O'Clock Cookbook £8.95	2044 U.S. Comp Chess £4.75
	Concurrent Basic Compiler £6.40	8080 Standard Assembler £9.95	IC O'Clock Cookbook £8.95	2045 U.S. Comp Chess £4.75
	Concurrent Basic Compiler £6.40	8080 Standard Assembler £9.95	IC O'Clock Cookbook £8.95	2046 U.S. Comp Chess £4.75
	Concurrent Basic Compiler £6.40	8080 Standard Assembler £9.95	IC O'Clock Cookbook £8.95	2047 U.S. Comp Chess £4.75
	Concurrent Basic Compiler £6.40	8080 Standard Assembler £9.95	IC O'Clock Cookbook £8.95	2048 U.S. Comp Chess £4.75
	Concurrent Basic Compiler £6.40	8080 Standard Assembler £9.95	IC O'Clock Cookbook £8.95	2049 U.S. Comp Chess £4.75
	Concurrent Basic Compiler £6.40	8080 Standard Assembler £9.95	IC O'Clock Cookbook £8.95	2050 U.S. Comp Chess £4.75
	Concurrent Basic Compiler £6.40	8080 Standard Assembler £9.95	IC O'Clock Cookbook £8.95	2051 U.S. Comp Chess £4.75
	Concurrent Basic Compiler £6.40	8080 Standard Assembler £9.95	IC O'Clock Cookbook £8.95	2052 U.S. Comp Chess £4.75
	Concurrent Basic Compiler £6.40	8080 Standard Assembler £9.95	IC O'Clock Cookbook £8.95	2053 U.S. Comp Chess £4.75
	Concurrent Basic Compiler £6.40	8080 Standard Assembler £9.95	IC O'Clock Cookbook £8.95	2054 U.S. Comp Chess £4.75
	Concurrent Basic Compiler £6.40	8080 Standard Assembler £9.95	IC O'Clock Cookbook £8.95	2055 U.S. Comp Chess £4.75
	Concurrent Basic Compiler £6.40	8080 Standard Assembler £9.95	IC O'Clock Cookbook £8.95	2056 U.S. Comp Chess £4.75
	Concurrent Basic Compiler £6.40	8080 Standard Assembler £9.95	IC O'Clock Cookbook £8.95	2057 U.S. Comp Chess £4.75
	Concurrent Basic Compiler £6.40	8080 Standard Assembler £9.95	IC O'Clock Cookbook £8.95	2058 U.S. Comp Chess £4.75
	Concurrent Basic Compiler £6.40	8080 Standard Assembler £9.95	IC O'Clock Cookbook £8.95	2059 U.S. Comp Chess £4.75
	Concurrent Basic Compiler £6.40	8080 Standard Assembler £9.95	IC O'Clock Cookbook £8.95	2060 U.S. Comp Chess £4.75
	Concurrent Basic Compiler £6.40	8080 Standard Assembler £9.95	IC O'Clock Cookbook £8.95	2061 U.S. Comp Chess £4.75
	Concurrent Basic Compiler £6.40	8080 Standard Assembler £9.95	IC O'Clock Cookbook £8.95	2062 U.S. Comp Chess £4.75
	Concurrent Basic Compiler £6.40	8080 Standard Assembler £9.95	IC O'Clock Cookbook £8.95	2063 U.S. Comp Chess £4.75
	Concurrent Basic Compiler £6.40	8080 Standard Assembler £9.95	IC O'Clock Cookbook £8.95	2064 U.S. Comp Chess £4.75
	Concurrent Basic Compiler £6.40	8080 Standard Assembler £9.95	IC O'Clock Cookbook £8.95	2065 U.S. Comp Chess £4.75
	Concurrent Basic Compiler £6.40	8080 Standard Assembler £9.95	IC O'Clock Cookbook £8.95	2066 U.S. Comp Chess £4.75
	Concurrent Basic Compiler £6.40	8080 Standard Assembler £9.95	IC O'Clock Cookbook £8.95	2067 U.S. Comp Chess £4.75
	Concurrent Basic Compiler £6.40	8080 Standard Assembler £9.95	IC O'Clock Cookbook £8.95	2068 U.S. Comp Chess £4.75
	Concurrent Basic Compiler £6.40	8080 Standard Assembler £9.95	IC O'Clock Cookbook £8.95	2069 U.S. Comp Chess £4.75
	Concurrent Basic Compiler £6.40	8080 Standard Assembler £9.95	IC O'Clock Cookbook £8.95	2070 U.S. Comp Chess £4.75
	Concurrent Basic Compiler £6.40	8080 Standard Assembler £9.95	IC O'Clock Cookbook £8.95	2071 U.S. Comp Chess £4.75
	Concurrent Basic Compiler £6.40	8080 Standard Assembler £9.95	IC O'Clock Cookbook £8.95	2072 U.S. Comp Chess £4.75
	Concurrent Basic Compiler £6.40	8080 Standard Assembler £9.95	IC O'Clock Cookbook £8.95	2073 U.S. Comp Chess £4.75
	Concurrent Basic Compiler £6.40	8080 Standard Assembler £9.95	IC O'Clock Cookbook £8.95	2074 U.S. Comp Chess £4.75
	Concurrent Basic Compiler £6.40	8080 Standard Assembler £9.95	IC O'Clock Cookbook £8.95	2075 U.S. Comp Chess £4.75
	Concurrent Basic Compiler £6.40	8080 Standard Assembler £9.95	IC O'Clock Cookbook £8.95	2076 U.S. Comp Chess £4.75
	Concurrent Basic Compiler £6.40	8080 Standard Assembler £9.95	IC O'Clock Cookbook £8.95	2077 U.S. Comp Chess £4.75
	Concurrent Basic Compiler £6.40	8080 Standard Assembler £9.95	IC O'Clock Cookbook £8.95	2078 U.S. Comp Chess £4.75
	Concurrent Basic Compiler £6.40	8080 Standard Assembler £9.95	IC O'Clock Cookbook £8.95	2079 U.S. Comp Chess £4.75
	Concurrent Basic Compiler £6.40	8080 Standard Assembler £9.95	IC O'Clock Cookbook £8.95	2080 U.S. Comp Chess £4.75
	Concurrent Basic Compiler £6.40	8080 Standard Assembler £9.95	IC O'Clock Cookbook £8.95	2081 U.S. Comp Chess £4.75
	Concurrent Basic Compiler £6.40	8080 Standard Assembler £9.95	IC O'Clock Cookbook £8.95	2082 U.S. Comp Chess £4.75
	Concurrent Basic Compiler £6.40	8080 Standard Assembler £9.95	IC O'Clock Cookbook £8.95	2083 U.S. Comp Chess £4.75
	Concurrent Basic Compiler £6.40	8080 Standard Assembler £9.95	IC O'Clock Cookbook £8.95	2084 U.S. Comp Chess £4.75
	Concurrent Basic Compiler £6.40	8080 Standard Assembler £9.95	IC O'Clock Cookbook £8.95	2085 U.S. Comp Chess £4.75
	Concurrent Basic Compiler £6.40	8080 Standard Assembler £9.95	IC O'Clock Cookbook £8.95	2086 U.S. Comp Chess £4.75
	Concurrent Basic Compiler £6.40	8080 Standard As		

from

TANGERINE
COMPUTER SYSTEMS

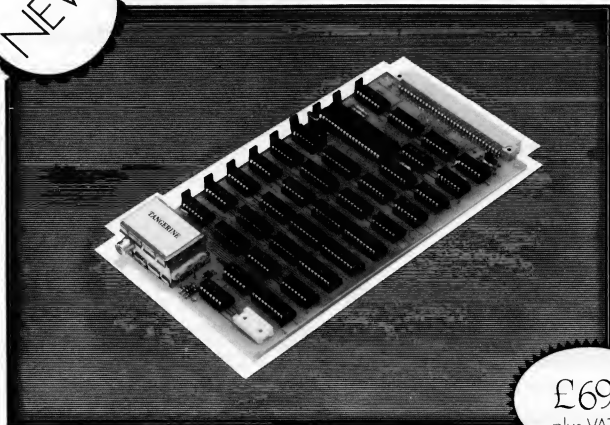

£69
plus VAT

microtan 65

- A 6502 based microcomputer • Superb 1K monitor TANBUG •
 - 1K RAM for user programme, stack and display memory •
 - VDU alphanumeric display on un-modified domestic T.V. of 16 rows by 32 characters • Optional lower case pack making a total of 128 displayable characters •
 - Optional chunky graphics (64x64pixels) •
- EXCELLENT DOCUMENTATION*

TANBUG

The most powerful 1K monitor available - TANBUG. Offers memory and register, examine, modify and list, block moves, single instruction, multiple non-destructive breakpoints with ability for multiple passes, address offset calculation and many other useful features

EXPANDABLE

TANEX - Expands the microtan 65 into a system. Provides 7K RAM, 6K ROM, 8K BASIC, 3 serial I/O (including RS232/20mA), 32 I/O lines and 4 16 bit programmable timers

AVAILABLE EX-STOCK FROM -
TANGERINE COMPUTER SYSTEMS,
FOREHILL, ELY, CAMBS. TEL. ELY3633

Please send me
 Microtan 65 kit - £79.35 Tanex kit min config - £49.45
 Microtan 65 assembled and tested - £90.85
 Lower case option - 10 95p Graphics option - 7 99p
 20 way keypad - £8.65 Full details 10p stamp please
 Name and address
 Prices include VAT. Please add 150p for P & P

3-LINE computing

DISKETTES

Top quality certified Verbatim disks.

only **£23.00 PLUS VAT** (per box of ten)

'MINI-KASSETTE' disk storage unit. Grey plastic case stores up to 10 diskettes. **PLUS £1.90 VAT**

BUSINESS PROGRAMS

3-line computing offer a complete range of 'in-house' business programs with sophisticated features and at competitive prices.

Includes: Advanced Weekly/Monthly PAYE **£140.00 PLUS VAT**
Integrated Stock Control/Invoicing **£160.00 PLUS VAT**
Nominal Ledger **£120.00 PLUS VAT**

We will also write programs to customers requirements at very competitive prices — write for details

36 CLOUGH RD, HULL HU5 1QL

SUPPORT MEMBERS OF THE COMPUTER
RETAILERS ASSOCIATION...



THEY WILL SUPPORT YOU.

For further details on the associations aims, membership, code of conduct etc.

Please contact: Ms. Heather Hodgson, 47, Creswell Road, Newbury, Berkshire. Tel. (0635) 42486.



Small
Systems
Engineering
Limited

IEEE-488/PET INTERFACES

Type B £186
Bidirectional serial interface is fully addressable and can have split BAUD rates

Type C £120
Serial interface - output only

Type CS £132
Serial interface output only with switchable character sets to match the new PET's lower case Screen mode

All interfaces are crystal controlled and are available with Special code conversions (ASCII/EBCDIC etc) by return (P.O.A.)

Type G.P.I. A.P. £249
Micro-based, bidirectional with buffering. The General Purpose Interface allows free use of PET's INPUT # statement without hangup problems. Software changeable BAUD rates and many other useful features

Addressable parallel (disk compatible) £106

Non addressable parallel £45

TV/Video monitor interface £35

Real Time Audio Spectrum Analyser for Commodore PET Microcomputer
32 Channels 1/2 Octave Filters, 1K ROM ROUTINES on board for analysis and graphical display. USR Functions for linkage to PET basic operating system £450

PET MEMORY EXPANSION BOARDS INTERNALLY MOUNTED

24K £328

32K £432

NEW... NEW... NEW... NEW...

Small Systems Engineering
introduces the -

PET COMPATIBLE DAISY WHEEL PRINTER S.S.E. RICOH R.P. 40

Printing Speed - 40 C.P.S.
Character-set - 96 characters, metal faced print wheel.

Line width - 136 characters
(10 characters per inch)

Line width - 163 characters
(12 characters per inch)

Form width - 16"

Integral PET IEEE-488 Addressable Interface
(Disc Compatible)

240v 50Hz

90 days Warranty

Maintenance Contracts available

**HIGH QUALITY PRINTING
AT LOW COST**

£1590

All prices exclude VAT
P&P £5.00 (includes Securicor Express Delivery)
62 New Cavendish Street · London W1M 7LD
Telephone: 01 637 0777 Telex: 8813085 (Abacus)

ALPHA MICRO
CROMEMCO
NORTH STAR
Multi-user/bank
select compatible

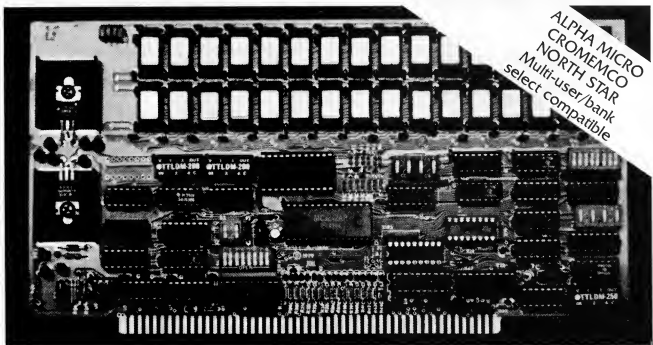

Model DMB-6400 Series dynamic 64k byte RAMS incorporate the features which are standard in the DM-6400 Series and adds bank select for multi-user-timesharing applications.

- ALPHA MICRO, CROMEMCO, and NORTH STAR output port bank select.
- Memory bank size can be incremented to 64k bytes in 16k increments.
- Four (4) 16k byte, functionally independent memory banks.
- Eight (8) 64k byte banks of memory per output port for expansion to 512k bytes for each output port.

Model DM-6400 Series dynamic 64k memory boards feature IEEE S-100 compatible timing and on board transparent refresh.

- Memory selectable and deselectable in 4k byte increments.
- 25 MHz on board crystal oscillator for independent timing.

DMB-6400 and DM-6400 Common Features:

- 4 MHz Z80 operation with no wait states.
- Tested and burned-in.
- Low power- 8 watts maximum.
- Reliable, expandable memories.

DMB Series Bank Select	64K - £595	48K - £539	32K - £483
DM Series Non Bank Select	64K - £449	48K - £398	32K - £346

One Year Guarantee



Small
Systems
Engineering
Limited

62 New Cavendish Street · London W1M 7LD Telephone: 01 637 0777

T.W. COMPUTERS LTD.

— for ITT 2020 Apple Microcomputers
in the Northwest

We can supply you with just a machine, or a
system tailored for your needs.

**MICROCOMPUTERS FROM £750 + VAT.
DISC SYSTEMS FROM £395 + VAT
PRINTERS FROM £510 + VAT**

PAYCLERK

— at last, a simple PAYE and WAGES
programme!

- PAYE and N.I. tables made redundant
- Calculates PAYE, N.I. and NET PAY
- Full details for wage book.

Only £ 45 + VAT.

In preparation, PAYMASTER prints wages book
and stores all PAYE information during the year.

T.W. COMPUTERS LTD. 293 London Road,
Hazel Grove, Stockport, Cheshire.
Tel. 061-456 8187.

CASIO FX 502P PROGRAMMABLE CALCULATOR



- LINES UP WITH AN ADAPTOR FOR PROGRAMME
DATA STORAGE ON STANDARD CASSETTES
- PLUS MUSIC SYNTHESIZING AND PLAY BACK
- 256 (non-volatile) memory registers and 22 (non-volatile)
are both protected (non-volatile)
- Up to 10 levels of parentheses nesting
- True algebraic logic: note how operations same as
written formulae
- Battery service life is 1 200 hours. Auto power off
feature is provided
- Thin and lightweight: easy to carry around
- Up to 10 programmes available: programme keys
otherwise usable as user's functions
- 51 built-in functions as well as 49 programmes
- A variety of jump commands (conditional
jumps, round-robin jumps and indirect jumps)
- 10 to 9 subroutines (incorporable: nesting possible
up to 9 levels)
- Easy to edit and debug programmes: PAUSE key,
random number key, back step/rapid run key
- Amazing programming speed

Optional FA-1 Programme Adaptor permits programme/data storage on standard cassette tape
recorders for re-entry. Typical storage/re-entry time 9-16 seconds, with a three digit code for
programme reference and identification. Also contains a music switch which converts both
calculators into musical synthesizers - duration of notes, rests, tempo, etc. and for any 40
programmable

MODEL FX 501P has an identical specification with the following exceptions: 128 steps (non-volatile)
programme memory capacity; 11 (non-volatile) data registers, up to 5 levels of parentheses
nesting, up to 9 subroutines, nestable up to 4 levels, up to 15 music notes (FX 502P up to 20)

Dimensions of both are: 96 mm x 71 mm x 141.2 mm (D x H x L). We x 5. D: A comprehensive
Programme Manual, Instruction Booklet and batteries will be supplied. FA-1 comes complete with a
demonstration cassette with the recorded programmes, including games and music.

AVAILABLE BY MAIL ORDER AT LOWEST DISCOUNT PRICES

FX 501P (RRP £84.95)	FX 502P (RRP £84.95)	FA-1 (RRP £24.95)
£54.95	£74.95	£19.95

Master Package deal: Premier Publications Master Pack software at only **£5**

When you buy the FX 501P and FA-1, or FX 502P and FA-1. Usual price **£19.95**
Master Pack comprises USER MANUAL with Basic and Advanced programming etc. 11.5 cassette
with over 150 ready to run programs. Full cassette library personal
Computer programmes, banking, diet, book-keepers, powerful sub-routines and data-packing

Prices include VAT at 10% and cost of packing. Send your Company order cheque or Postal Order or phone your
ACCESS to BARNET CARD number to

TEMPUS DEPT PCW
THE BEAUMONT CENTRE
14-15 EAST ROAD
CAMBRIDGE CB1 1DB
Tel: (0223) 312886



NEW EUROPEAN PRINTER

- * Versatile matrix printer with no hidden extras.
- * Fully compatible with all main computers — no
additional hardware needed; PET handshake
routine, RS232 and V24 all standard features.
- * Has primary and secondary addressing capability
allowing not only single and double width characters
but also full PET graphics.
- * Uses plain paper

* Choice of blue or black ribbon

80 column bi-directional **£590 + VAT**
52 column bi-directional **£490 + VAT**

Journal printers etc. also available. For further details write
to UK distributors:

Barnes Consultants, 36 Eaton Court, Boxgrove Ave., Guildford, Surrey
Tel: Guildford 60982

S.D. SYSTEMS inc. S100 COMPUTER CARDS & SYSTEMS

AS OF JANUARY 1st 1980 PRICES OF S.D. PRODUCTS WILL BE GOING UP.
ORDERS PLACED BEFORE CHRISTMAS FOR DELIVERY DURING JANUARY WILL BE AT CURRENT PRICE.



SBC 100

- * X 80 CPU
 - * SERIAL I/O PORT
 - * PARALLEL I/O PORT
 - * 4 CHANNEL COUNTER TIMER
 - * 1K RAM, 8K EPROM
 - * S100 BUS
 - * OPTIONAL VECTORED INTERRUPTS
- PRICE: £159.00 KIT, £199.00 BUILT AND TESTED
SBC 200 4MHz as above PRICE: £177.00 KIT:
£237 BUILT AND TESTED

EXPANDORAM

- * 8K TO 64K
 - * WRITE PROTECT
 - * INTERFACES WITH ALTAIR, IMSAI SOL-8, CROMENCO & SBC 100
 - * S100 BUS
 - * OPERATES WITH Z-80, 8080, 8085 CPUs
 - * 2.5 MHz OPERATION
- KIT
PRICE: 16K £175.00 32K £225.00 48K £375.00
64K £325.00
BUILT & TESTED
PRICE: 16k £270.00 32k £320.00 48k £370.00
64k £420.00

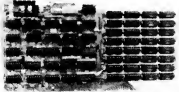

EXPANDORAM II

- * AS ABOVE BUT EXPENDABLE FROM 16 to 256K
 - * COMPATIBLE WITH Z-80 CPU
 - * 4MHz OPERATION
- KIT PRICE: 16k £198.00; 32k £268.00; 48k £338.00;
64k £399.00.
BUILT AND TESTED
PRICE: 16k £295.00; 32k £365.00; 48k £435.00; 64k
£495.00

PROM 100

- * PROGRAMS THE FOLLOWING PROMS: 2708, 2758, 2716, 2732, 2516
 - * PROGRAM PULSE GENERATED ON BOARD
 - * LOW POWER REQUIREMENT
 - * S100 BUS
 - * MAX PROGRAMMING TIME 100 SECS (16K)
 - * PROGRAM VERIFICATION
 - * SOFTWARE SUPPLIED
- PRICE: £89.00 KIT, £123.00 BUILT AND TESTED

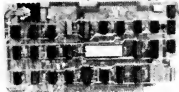

AIRAMCO 1050 DISK BOX

- * CONTAINS 2 MFE 750 8" DOUBLE SIDED DRIVES
PLUS POWER SUPPLY AND CONNECTOR CABLES
- PRICE: £1495

VERO S100 RACK SYSTEM

- * 6 SLOT MOTHERBOARD
 - * POWER SUPPLY ETC
- PRICE: £275.00

VERSAFLOPPY

- * IBM 3740 COMPATIBLE
 - * UP TO 4, 5 or 8" DRIVES
 - * SINGLE OR DOUBLE SIDED
 - * Z-80, 8080, 8085 CPUs
 - * S100 BUS
 - * USES FD 1771B-1 CONTROLLER CHIP
- PRICE: £139.00 KIT, £198 B&T

VERSAFLOPPY II

- * AS ABOVE BUT DOUBLE DENSITY & ANY COMBINATION OF DRIVE SIZES, UP TO 4 SIMULTANEOUSLY, USES FD1791-1 CONTROLLER CHIP
- PRICE: £192.00 KIT. £295.00 B&T

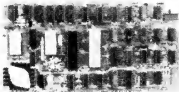

VDB 8024

- * FULL 80 x 24 DISPLAY
 - * 7 x 10 MATRIX
 - * KEYBOARD INTERFACE
 - * VIDEO & TTL OUTPUT
 - * 2K INDEPENDENT ON BOARD MEMORY
 - * 8 ON BOARD Z-80 CPU
 - * 96 UPPER & LOWER CASE CHARACTERS
 - * 32 SPECIAL CHARACTER SET
 - * 128 ADDITIONAL PROGRAMMABLE CHARACTER SET
- PRICE: £198.00 KIT £280.00 B&T

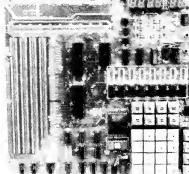

STARTER KIT

- * ON-BOARD KEYBOARD & DISPLAY
 - * CASSETTE INTERFACE
 - * PROM PROGRAMMER
 - * 1K RAM, 6K EPROM, P/I/O, CTC, MON.
- PRICE: £188.00 KIT £267.00 B&T

COMPONENTS

2708 1024 x EPROM	6.00
2716 2048 x 8 EPROM	26.50
1771B-1 FLOPPY DISK CONTROLLER	29.95
21L02 1k x 1 (450ns) - per 8	7.50
21L02 1k x 1 (250ns) - per 8	8.95
2114 1k x 4 (450ns)	4.99
4115 8k x 1 (250ns) DYNAMIC - per 8	25.00
4116 16k x 1 DYNAMIC - per 8	69.00
AY5 1013 UART	4.50
AY5 1014 UART (5V)	6.50
AY5 3600 ENCODER	9.99
8080A CPU	8.99
4044 4K x 1 (450ns)	7.45
4215 16K x 1 (250ns) - per 8	47.50

MIKRO 525 computer system
S100 BUILT AND TESTED 6 slot main frame.
All power supplies 2 x 5 1/8" disc drives, 280 CPU/CTC
I/O SERIAL I/O, I/O Parallel I/O

32k RAM expandable to 64k

CPM compatible SDOS operating system.

PRICES FROM £1295.00 in KIT form
BUILT AND TESTED available.

All prices exclusive of VAT @ 15%
FOR COMPONENTS PLEASE ADD 40p P&P
THEN ADD V.A.T. @ 15%

AIRAMCO LIMITED
UNIT A2, 9 LONGFORD AVENUE, KILWINNING INDUSTRIAL ESTATE, KILWINNING Ayrshire KA13 6EX
TEL: 0294 57755. TELEX: 779808

C.J. Communications

FLOPPY DISKS

Our high quality disks are manufactured in Santa Clara, California.

All disks are delivered free of defects in materials and workmanship.

Performance is guaranteed for a minimum of 12 months.

5¼" SINGLE £24.75 per 10

" DOUBLE £32.40 per 10

8" SINGLE £26.50 per 10

" DOUBLE £44.15 per 10

Also available in single units

PLEASE SPECIFY EQUIPMENT WHEN ORDERING

CONTINUOUS FORMS

We offer a comprehensive form design service to meet your special requirements.

Send details of your needs.

Stock forms

11" x 8½" (2,000s) £9.50

11" x 9½" (2,000s) £10.60

All our prices include VAT and delivery. SAE for lists

9, DALE CLOSE, TODDINGTON,
Nr. DUNSTABLE, BEDS. LU5 6EP.

Tel.: (05255) 2207

CONTRACTS IN EUROPE

Our associates in Europe are urgently seeking high level experienced IBM Systems Programmers, Analyst Programmers and good application Programmers.

COBOL/PL1 and Assembler are the major languages required.

The better paid contracts will require a knowledge of German, French or Dutch.

Contracts are long term and will pay c.£350 per week dependent on experience.

Please call Stephen Haines at:
OUNLOP & BADENOCH
COMPUTER SERVICES
31 Percy Street, W1 323 0886



Micro-Computer Centre for the MIDLANDS

Nascom and Commodore Specialists

A full range of micro computers and peripherals are available, whether buying or browsing we can give helpful and friendly advice.

Nascom 2 complete kit ex. stock £295.00 + VAT or fully built and tested £335.00 + VAT.

Nascom 1 super new low prices £125.00 + VAT or fully built and tested £140.00 + VAT.

This has to be the best starting point for anyone interested in Micro Computing.

We are now sole distributors for the Micro Type case for your Nascom 1 & 2, also stockists of the William Stuart colour graphics and full range of add ons.



Business & Leisure Micro Computers

16 The Square, Kenilworth, Warwickshire CV8 1EB.

Tel: (0926) 512127

ADVERTISERS INDEX

Abacus	76	Digital Design & Devt	118	Low Electronics	13	Research Machines	27
Acorn Computers	3	Display Electronics	21	Mersey Micro Show 9		Rohan Computing	122
ACT 800 Dealers	44-46	Dunlop Badenock	130	Microcontrol	28	Mike Rose (Micros)	123
Aculab	8	Dynabyte	49	Microcomputer		Rostronics	121
Adda Computers	22	Ensign	115	Business Machines	23	Science of Cambridge	98
Airmaco	129	Gemsoft	26	Microcentre		IFC	30
Almarc Data Systems	28,112	GW Computers	4	Microdata	22	Sirton	25
Barnes Consultants	128	HB Computers	114	Microdigital	26,124	Small Systems Eng.	127
BFI Electronics	8	AJ Harding (Molimerx)	7	Micromedia	84	Southwark	119
Bits and PC's	116	Happy Memories	110	Microsolve	26	Stack	10
Business & Leisure	130	Heath Zenith	75	Millbank Computing	112	SEED	50
Buss Stop	120	Henry's	114	Mine of Information	122	Sumlock Bondain	64
Cambridge Learning	22	Hitech	124	Mutek	120	Tandy Corp	18,19
Carter	8	Interactive Data	112	Newbear	113,118	Tangerine	125
CCS	120	Interface	29	NIC	116	Teleprinter Eqp't	83
CJ Communications	130	Intex Datalog	6	Optronics	124	Tempus	128
Comart	16,68	Katanna	24	Orchard	131	3 Line Computing	126
Commodore	35,76	L&J Computers	110	Petalect	31	Transam	88
Comp Shop	132,11C	Lion House	5	Personal Computers	5	Tridata	119
Computerama	111	Little Genius	114	Petsoft	36	TVJ Microcomputers	14,15
CRA	126	Liveport Data Products	11	PHL	6	TW Computers	128
Cumana	2	Logitek	74	PIPS	116	Vlasak	55
Currah	22	Lotus Sound	12	Pyral Magnetics	65	John Wiley	20
DAMS Computer Divn	123	Liteboat	117	Premier Publications	12	Xitan Systems	17
Datron Microcentre	110	LP Enterprises	24	Prentice Hall	59		

PET, COMPUTHINK & ANADEX IN THE HOME COUNTIES

With every order received in the next week
for 16K or 32K Pet and Petsoft Programmers
Toolkit (RRP £55) for £5.00.
TCM 100 Thermal Printer (40 column) £243
+ VAT (PET interface £49 + VAT)



New Keyboard Pets & Peripherals



Anadex Printers
(Dealer enquiries welcome)

Computhink Disc Drives



Orchard Electronics Ltd (Ask for Dave or Barry)
21 St Martins Street
Wallingford
Oxon OX10 0DE

Comprehensive demonstration facilities available (by appointment)

* Also call us for your component requirements *

8MHz Super Quality Modulators	£4.90
6MHz Standard Modulators	£2.90
C12 Computer Grade Cassettes 10 for £4.00	
Super Multi-rail P.S.U. +5 -5 +12v	£29.50
Nascom I with Nas-sys Kit Assembled } Limited quantities	Special Price £125.00 £140.00
ETI Breakout Game — Chip and PCB	£9.90
S100 Expansion Motherboard for Nascom I	£39.00
Anadex Printer Paper — 2000 sheets	£25.00
Floppy Disks 5¼" Hard & Soft Sectored	£3.50
Floppy Disk Library Case 5¼"	£3.50
Lexicon Language Translator	£125.00
Modules for Lexicon	£29.00
EPROM Boards	£63.00
8K Static Ram Boards — S100	£110.00
Grandstand Video Game	£59.00
Cartridges for Grandstand	£11.99
George Risk Ascii Keyboard	£39.00
Cartridges for Atan — Full Range in Stock	£13.90
Interface PET IEEE — Centronics Parallel Not decoded	£49.00
Decoded	£77.00
Interface to Centronics parallel for TRS80	£75.00
Verocases for Nascom 1 & 2 etc.	£22.50
Keyboard Cases	£9.90
Electric Pencil for TRS80	£29.00



HITACHI PROFESSIONAL MONITORS

9" — £129
12" — £199

- **Reliability** Solid state circuitry using an IC and silicon transistors ensures high reliability.
- **500 lines horizontal resolution** Horizontal resolution in excess of 500 lines is achieved in picture center.
- **Stable picture** Even played back pictures of VTR can be displayed without jittering.
- **Looping video input** Video input can be looped through with built-in termination switch.
- **External sync operation** (available as option for U and C types).
- **Compact construction** Two monitors are mountable side by side on a standard 19-inch rack.

A PROFESSIONAL WORD PROCESSING SYSTEM AND IT'S A COMPUTER AS WELL.

FOR ONLY
£3250 - VAT



RET 32K — This is the standard 32K Pet from Commodore. Reverse video and graphics allow the WordPro Package to give simple clear and easy to read displays.

2040 Disk Drives Twin disk drives allow large high speed storage for your letters, or paragraphs. Plugs in the back of the PET.

NEC Spinwriter NEC's high quality printer gives a print "thimble" that has less diameter and inertia than a daisy wheel,

only **£399** + VAT

TRS80 LEVEL 2 16K
Fully converted to UK T.V. Standard! Comes complete with easy to follow manuals. UK Power Supply — Cassette Leads — Sample tapes. Special box to enable you to plug into your own TV. Recommended for first-time buyers. Just plug in and go. Full Range of Software Available

NEW REDUCED PRICES

8K **£449** + VAT
16K **£549** + VAT
32K **£649** + VAT

RRP £795 for 32K

The PEDIGREE PETS
Very popular for home & business use. 8K Microsoft Basic in ROM. 8K Pet 32k & 16k, with new improved keyboard. All with green screen.
Extra cassette deck. £56 Full range of software available.

32K **£690** - VAT
48K **£790** + VAT

EXIDY SORCERER RRP £859 for 32K

For Personal or Business Use.
32K or 48K memory. 8K Microsoft Basic in ROM. Dual Cassette I/O. RS232 I/O. Parallel I/O (Centronics). Expansion available through optional serial S100 Motherboard. 69 key keyboard including 16 key numeric pad.

S100 EXPANSION — £199

RRP £975 for 48K

48K — **£690** - VAT

ITT 2020
Full colour into your own colour T.V. PALSOFT 8 digit floating point Basic in ROM as standard. Low and High resolution graphics. Built in loudspeaker. Compatible with most Apple Hardware add-ons and software.

only **£295** + VAT

Expand your TRS80 by 32K

TRS80 EXPANSION INTERFACE

32K Memory on board. Centronics parallel port. Disk controller card. Real time clock. Requires Level II Basic interface for 2 cassette decks. complete with power supply.

RRP £540

only **£499** + VAT

ANADEX DP8000

Super Quality — Low cost printer. Tractor Feed with full 96 ASCII character set. Accepts RS232C at baud rates between 100 and 9600 and Parallel Bt data. Attaches either directly or through interfaces to Pet, Apple, TRS80, Sorcerer, Nascom, Komputek etc.

RRP £690

only **£590** + VAT

IBM SELECTRIC GOLFBALL

Refurbished IBM Golfball Printers to new specs. Accepts Centronics parallel data. Fraction feed. Prints at 15 cps.

Attaches either directly or through interfaces to Pet, Apple, TRS80, Sorcerer, Nascom, Komputek etc.

video 100

12" BLACK & WHITE LOW COST VIDEO

RRP £79

only **£69** + VAT

- Ideal for home, personal and business computer systems
- 12" diagonal video monitor
- Composite video input
- Composite video input
- Compatible with many computer systems
- Solid-state circuitry for a stable & sharp picture
- Video bandwidth — 12MHz — 30B
- Input impedance — 75 Ohms
- Resolution — 620 lines Minimum in Central 80% of CRT; 505 Lines Minimum beyond central 80%.

NASCOM-2 MICRO-COMPUTER

only **£295** + VAT

FREE POWER SUPPLY

Microprocessors Z80A 8 bit CPU. This will run at 4MHz but is selectable between 1.274 MHz. This CPU has now become generally accepted as the most powerful, 8 bit processor on the market.

INTERFACE
Keyboard New expanded 57 key Licon solid state keyboard especially built for Nascom. Uses standard Nascom, monitor controlled, decoding.
T.V. The tv peak to peak video signal can drive a monitor directly and is also fed to the on-board modulator to drive the domestic T.V.
I.O. On-board UART (int 6402) which provides serial handling for the on-board cassette interface or the RS232C/20MA teleprinter interface.
The cassette interface is Kansas City standard at either 300 or 1200 baud. This is a link option on the NASCOM-2.
The RS232C and 20MA loop connector will interface directly into any standard teletype.
The input and output sides of the UART are independently switchable between any of the options — i.e. it is possible to house input on the cassette and output on the printer.
PIO There is also a totally uncommitted Parallel I/O (MK3881) giving 16, programmable, I/O lines. These are addressable as 2 x 8 bit ports with complete handshaking controls.
Documentation Full construction article is provided for those who buy a kit and an extensive software manual is provided for the monitor and Basic.
Basic The Nascom 2 contains a full 8K Microsoft Basic in one ROM chip with additional features like DEEK, DOKK, SET, RESET for simple programming.
With 16K RAM board

COMPUKIT UK101

EUROPE'S FASTEST SELLING ONE BOARD COMPUTER



Simple Soldering due to clear and concise instructions compiled by
Dr. A.A. Berk, BSc. PhD

- ★ 6502 based system — best value for money on the market.
- ★ Powerful 8K Basic — Fastest around
- ★ Full Qwerty Keyboard
- ★ 4K RAM Expandable to 8K on board.
- ★ Power supply and RF Modulator on board.
- ★ No Extras needed — Plug-in and go.
- ★ Kansas City Tape Interface on board.
- ★ Free Sampler Tape including powerful Dissampler and Monitor with each Kit.
- ★ If you want to learn about Micros, but didn't know which machine to buy then **this is the machine for you.**

Build, Understand and Program your own Computer for only a small outlay

KIT ONLY **£199** + VAT
NO EXTRAS NEEDED

AVAILABLE READY ASSEMBLED & TESTED
READY TO GO FOR **£249** + VAT

Specialty designed case for CompuKit in orange/black. With room for accessories. **£29.50** + VAT

6502 Assembler/Editor for CompuKit **£14.90** + VAT

The **CompuKit UK101** comes in kit form with all the parts necessary to be up and working, supplied. No extras are needed. After plugging in just press the reset keys and the whole world of computing is at your fingertips. Should you wish to work in the machine code of the 6502 then just press the M key and the machine will be ready to execute your commands and programs. By pressing the C key the world of Basic is open to you.

This machine is ideal to the computing student or Maths student, ideal to teach your children arithmetic, and is also great fun to use.

Because of the enormous volume of users of this kit we are able to offer a **new reduced price of £199** + VAT

THE NEW TRS80 SURPRISE — MODEL II

Fast and expandable!

Model II operates at twice TRS-80's high speed.

In addition to either 32 or 64 thousand characters (bytes) of Internal Random Access Memory, one built-in 8" floppy disk stores an additional one-half million bytes, including the Disk Operating System. And you can easily expand up to a four-disk system for up to two-million bytes of storage.

Model II features upper and lower case letters. Its built-in 12" high-resolution video monitor displays 24 lines of 80 normal characters. The professional 76-key keyboard (with "calculator" keypad) includes advanced functions such as Control, Escape, Caps, Hold, Repeat. The keyboard is detachable and moveable for convenient data entry.

You get the enhanced Level III version of TRS-80's already famous Level II BASIC language and "TRSDOS" operating system, automatically loaded in memory when you "power up." (About 24K of RAM is used by this software.)

Each time you power up, Model II thoroughly tests itself to insure proper operation. Your chosen program can appear immediately, without any intermediate steps or operations to answer.

Versatility ... plug-in expandability

Built-in input/output capabilities include two RS-232C channels, and one Centronics parallel port. Future expansion is provided for through four plug-in slots for optional PC boards.

32K 1-Disk Model II 64K 1-Disk Model II

£1999.00 + VAT

£2200.00 + VAT

3 DISK EXPANSION

500K per Drive gives total of
1.5M Byte for only **£1399** + VAT

Just Plug
In

**WE ARE NOW
EX-STOCK**



EXTRA
REPAIR
SERVICE
ON
COMPUKITS

Why do people buy more from COMP SHOP than anywhere else?

- LARGER STOCKS — we hardly ever run out.
- GOOD SERVICE — we give extended warranties on all our products.
- EXCELLENT REPAIR SERVICE — Through CompuCare we repair and maintain most makes of personal computers.

LAST YEAR WE SUPPLIED TO THE PUBLIC — LARGE & SMALL
16,000 Television Games & 7,000 Computer Systems

COMPUCARE

CompuCare is a company that has been set up to provide servicing and maintenance for the popular makes of micro-computers i.e. Sorcerer, Pet, Apple, TRS80, Nascom, CompuKit. Our charges are £7 per hour plus parts.

Because of the extensive range of spare parts stocked you can usually expect your micro to be repaired within 10 days for an average charge of £14 labour.

Emergency 24 hour repairs can be handled for a £10 surcharge where possible. CompuKits and Nascoms unsuccessfully constructed will be charged a standard £25.



THE ATARI VIDEO COMPUTER SYSTEM

£138
+ VAT

Atari's Video Computer System now offers more than 1300 different game variations and options in twenty great Game Program™ cartridges!

Have fun while you sharpen your mental and physical coordination. You can play rousing, challenging, sophisticated video games, the games that made Atari famous. You'll have thrill after thrill, whether you're in the thick of a dogfight, screaming around a racetrack, or dodging asteroids in an alien galaxy. With crisp bright colour (on colour TV) and incredible, true-to-life sound effects. With special circuits to protect your TV.

Cartridges now available All at **£12.90** each + VAT

Basic Maths, Airsea Battle, Black Jack, Breakout, Surround, Spacewar, Video Olympics, Outlaw, Basketball, Hunt & Score, Space War, Sky Diver, Air Sea Battle Codebreaker*, Miniature Golf.

Extra Paddle Controllers
— **£14.90** + VAT

*Keyboard Controllers
— **£16.90** + VAT

Please add VAT to all prices — Delivery at cost, will be advised at time of purchase. Please make cheques and postal orders payable to COMP SHOP LTD., or phone your order quoting BARCLAYCARD, ACCESS, DINERS CLUB or AMERICAN EXPRESS number. CREDIT FACILITIES ARRANGED — send S.A.E. for application form.

14 Station Road, New Barnet, Hertfordshire, EN5 1QW Telex: 298755 TELCOM G

Telephone: 01-441 2922 (Sales) 01-449 6596

OPEN - 10 am - 7 pm — Monday to Saturday

★ NOW OPEN ALL DAY SUNDAY — For Shop Sales Only ★

Close to New Barnet BR Station — Moorgate Line.

**COMP
SHOP**

COMP COMPUTER
COMPONENTS
(Part of the Comshop Ltd. Group)



"My best Apple programs are on long-term deposit in the City... it pays rather well!"

We brought the first five Apples into the U.K. in November '77, with every penny we had. In November '79, we find several thousand throughout the country.

THANK YOU Apple owners.

Now we'd like to help you re-coup your investment by cataloguing and supporting the best Apple programs in the U.K. The Apple Software Bank is more like an old penny bank than a major clearing bank, but we know you'll help it grow. Telephone Stephen Derrick on 01-626-8121 to discuss your investment.

ATTENTION ALL Estate Agents, Employment Agencies, Yacht Brokers, Antique Dealers and Motor Traders.

Find out about **FINDER SOFTWARE!**

SOME BLUE CHIPS

TESKIM. This ROM will simulate the Tektronix 4010 family of graphics terminals. It's rather good!

UPPER LOWER CASE ADAPTOR A chip for the chap considering word processing.

NEW ISSUES

We are continually trying to bring the latest add-ons for your Apples. Please phone for the latest product information and data sheets.

NEW PRODUCTS

8" SHUGART DISKS giving 1.2 Megabytes A twin drive (with room for a third.) disk system with controller and software, give tremendous commercial possibilities. £2350 Excl. V.A.T.

WORD PROCESSOR. Ask about our Apple II Plus word processor package. Complete System with Diablo 1650 Daisy-Wheel Printer. £4250 Excl. V.A.T.

PERSONAL COMPUTER PRINTERS. Sensational 40 & 80 Character printer (graphics options) from £243 Excl. V.A.T. Interfaces for Apple, Pet & TRS 80. High quality silent printers. It's your choice!

A/D BOARD At last we have either an 8 bit or 12 bit A/D card for Apple. Excellent spec from £125 Excl. V.A.T.

APPLE PASCAL £296



Personal Computers Limited

194-200 Bishopsgate, London EC2M 4NR.

Let us advise you about **COLOUR DISPLAY** on your Apple. Contact Technical Services.

